



Chipsmall Limited consists of a professional team with an average of over 10 year of expertise in the distribution of electronic components. Based in Hongkong, we have already established firm and mutual-benefit business relationships with customers from,Europe,America and south Asia,supplying obsolete and hard-to-find components to meet their specific needs.

With the principle of “Quality Parts,Customers Priority,Honest Operation,and Considerate Service”,our business mainly focus on the distribution of electronic components. Line cards we deal with include Microchip,ALPS,ROHM,Xilinx,Pulse,ON,Everlight and Freescale. Main products comprise IC,Modules,Potentiometer,IC Socket,Relay,Connector.Our parts cover such applications as commercial,industrial, and automotives areas.

We are looking forward to setting up business relationship with you and hope to provide you with the best service and solution. Let us make a better world for our industry!



## Contact us

Tel: +86-755-8981 8866 Fax: +86-755-8427 6832

Email & Skype: info@chipsmall.com Web: www.chipsmall.com

Address: A1208, Overseas Decoration Building, #122 Zhenhua RD., Futian, Shenzhen, China





## Thyristor High Voltage, Phase Control SCR, 25 A

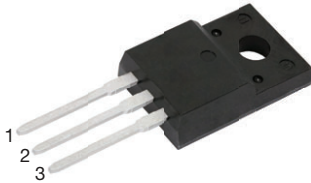

3L TO-220 FullPAK

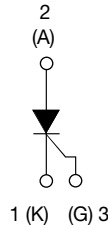

### FEATURES

- Designed and qualified for industrial level
- Fully isolated package ( $V_{INS} = 2500 V_{RMS}$ )
- UL pending
- 125 °C max. operating junction temperature
- Material categorization: for definitions of compliance please see [www.vishay.com/doc?99912](http://www.vishay.com/doc?99912)



**RoHS**  
COMPLIANT  
HALOGEN  
**FREE**

### APPLICATIONS

- Typical usage is in input rectification crowbar (soft start) and AC switch in motor control, UPS, welding, and battery charge

### DESCRIPTION

The VS-25TTS...FP... high voltage series of silicon controlled rectifiers are specifically designed for medium power switching and phase control applications. The glass passivation technology used has reliable operation up to 125 °C junction temperature.

PRIMARY CHARACTERISTICS	
$I_{T(AV)}$	16 A
$V_{DRM}/V_{RRM}$	800 V, 1200 V
$V_{TM}$	1.25 V
$I_{GT}$	45 mA
$T_J$	-40 °C to 125 °C
Package	3L TO-220 FullPAK
Circuit configuration	Single SCR

OUTPUT CURRENT IN TYPICAL APPLICATIONS			
APPLICATIONS	SINGLE-PHASE BRIDGE	THREE-PHASE BRIDGE	UNITS
Capacitive input filter $T_A = 55$ °C, $T_J = 125$ °C, common heatsink of 1 °C/W	18	22	A

MAJOR RATINGS AND CHARACTERISTICS			
PARAMETER	TEST CONDITIONS	VALUES	UNITS
$I_{T(AV)}$	Sinusoidal waveform	16	A
$I_{RMS}$		25	
$V_{RRM}/V_{DRM}$		800, 1200	V
$I_{TSM}$		350	A
$V_T$	16 A, $T_J = 25$ °C	1.25	V
dV/dt		500	V/μs
dI/dt		150	A/μs
$T_J$		-40 to +125	°C

VOLTAGE RATINGS			
PART NUMBER	$V_{RRM}$ , MAXIMUM PEAK REVERSE VOLTAGE V	$V_{DRM}$ , MAXIMUM PEAK DIRECT VOLTAGE V	$I_{RRM}/I_{DRM}$ AT 125 °C mA
VS-25TTS08FP-M3	800	800	10
VS-25TTS12FP-M3	1200	1200	



ABSOLUTE MAXIMUM RATINGS						
PARAMETER	SYMBOL	TEST CONDITIONS	VALUES		UNITS	
			TYP.	MAX.		
Maximum average on-state current	$I_{T(AV)}$	$T_C = 51\text{ }^\circ\text{C}$ , 180° conduction half sine wave	16		A	
Maximum RMS on-state current	$I_{RMS}$		25			
Maximum peak, one-cycle, non-repetitive surge current	$I_{TSM}$	10 ms sine pulse, rated $V_{RRM}$ applied	300			
		10 ms sine pulse, no voltage reapplied	350			
Maximum $I^2t$ for fusing	$I^2t$	10 ms sine pulse, rated $V_{RRM}$ applied	450		$A^2s$	
		10 ms sine pulse, no voltage reapplied	630			
Maximum $I^2\sqrt{t}$ for fusing	$I^2\sqrt{t}$	$t = 0.1\text{ms to }10\text{ms}$ , no voltage reapplied	6300		$A^2\sqrt{s}$	
Maximum on-state voltage drop	$V_{TM}$	16 A, $T_J = 25\text{ }^\circ\text{C}$	1.25		V	
On-state slope resistance	$r_t$	$T_J = 125\text{ }^\circ\text{C}$	12.0		$m\Omega$	
Threshold voltage	$V_{T(TO)}$		1.0		V	
Maximum reverse and direct leakage current	$I_{RM}/I_{DM}$	$V_R = \text{Rated } V_{RRM}/V_{DRM}$	$T_J = 25\text{ }^\circ\text{C}$	0.5		mA
			$T_J = 125\text{ }^\circ\text{C}$	10		
Holding current	$I_H$	Anode supply = 6 V, resistive load, initial $I_T = 1\text{ A}$ , $T_J = 25\text{ }^\circ\text{C}$	-	150		
Maximum latching current	$I_L$	Anode supply = 6 V, resistive load, $T_J = 25\text{ }^\circ\text{C}$	200			
Maximum rate of rise of off-state voltage	$dV/dt$	$T_J = T_J \text{ max.}$ , linear to 80 %, $V_{DRM} = R_g - k = \text{Open}$	500		$V/\mu s$	
Maximum rate of rise of turned-on current	$dI/dt$		150		$A/\mu s$	

TRIGGERING					
PARAMETER	SYMBOL	TEST CONDITIONS	VALUES	UNITS	
Maximum peak gate power	$P_{GM}$		8.0	W	
Maximum average gate power	$P_{G(AV)}$		2.0		
Maximum peak positive gate current	+ $I_{GM}$		1.5	A	
Maximum peak negative gate voltage	- $V_{GM}$		10	V	
Maximum required DC gate current to trigger	$I_{GT}$	Anode supply = 6 V, resistive load, $T_J = -10\text{ }^\circ\text{C}$	60		mA
		Anode supply = 6 V, resistive load, $T_J = 25\text{ }^\circ\text{C}$	45		
		Anode supply = 6 V, resistive load, $T_J = 125\text{ }^\circ\text{C}$	20		
Maximum required DC gate voltage to trigger	$V_{GT}$	Anode supply = 6 V, resistive load, $T_J = -10\text{ }^\circ\text{C}$	2.5		V
		Anode supply = 6 V, resistive load, $T_J = 25\text{ }^\circ\text{C}$	2.0		
		Anode supply = 6 V, resistive load, $T_J = 125\text{ }^\circ\text{C}$	1.0		
Maximum DC gate voltage not to trigger	$V_{GD}$	$T_J = 125\text{ }^\circ\text{C}$ , $V_{DRM} = \text{Rated value}$	0.25		
Maximum DC gate current not to trigger	$I_{GD}$		2.0		mA

SWITCHING					
PARAMETER	SYMBOL	TEST CONDITIONS	VALUES	UNITS	
Typical turn-on time	$t_{gt}$	$T_J = 25\text{ }^\circ\text{C}$	0.9		$\mu s$
Typical reverse recovery time	$t_{rr}$	$T_J = 125\text{ }^\circ\text{C}$	4		
Typical turn-off time	$t_q$		110		



THERMAL AND MECHANICAL SPECIFICATIONS				
PARAMETER	SYMBOL	TEST CONDITIONS	VALUES	UNITS
Maximum junction and storage temperature range	$T_J, T_{Stg}$		-40 to 125	°C
Maximum thermal resistance, junction to case	$R_{thJC}$	DC operation	2.5	°C/W
Maximum thermal resistance, junction to ambient	$R_{thJA}$		62	
Typical thermal resistance, case to heatsink	$R_{thCS}$	Mounting surface, smooth, and greased	0.5	
Approximate weight			2	g
			0.07	oz.
Mounting torque	minimum		6 (5)	kgf · cm (lbf · in)
	maximum		12 (10)	
Marking device		Case style 3L TO-220 FullPAK	25TTS08FP	
			25TTS12FP	

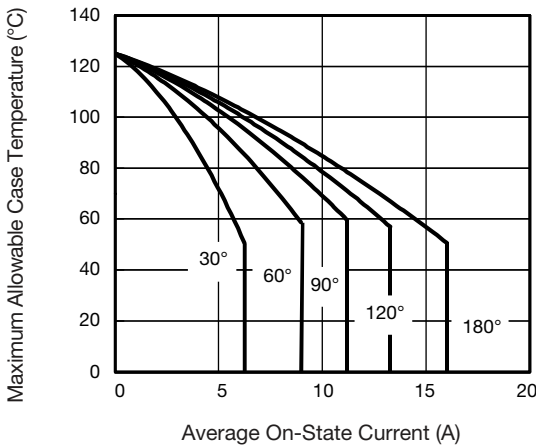

Fig. 1 - Current Rating Characteristics

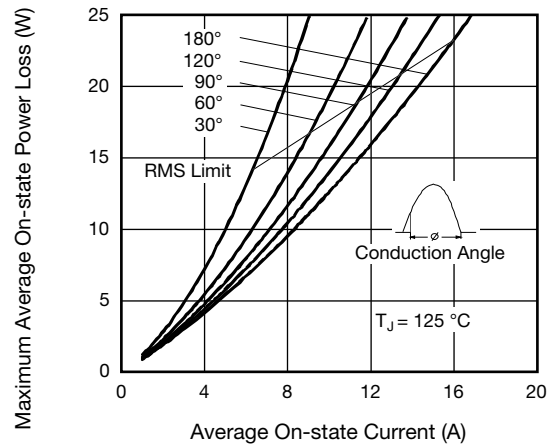

Fig. 3 - On-State Power Loss Characteristics

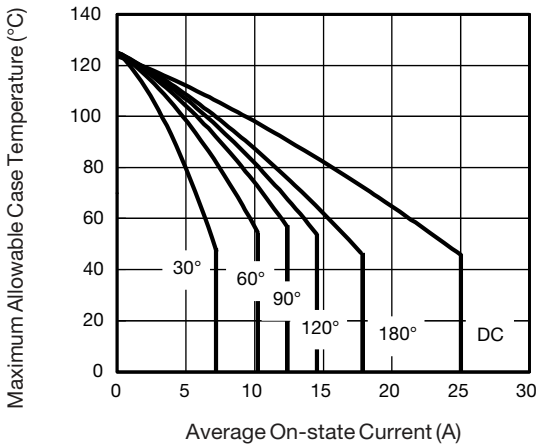

Fig. 2 - Current Rating Characteristics

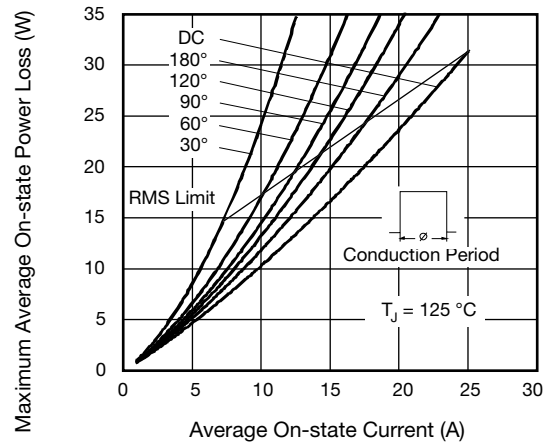

Fig. 4 - On-State Power Loss Characteristics

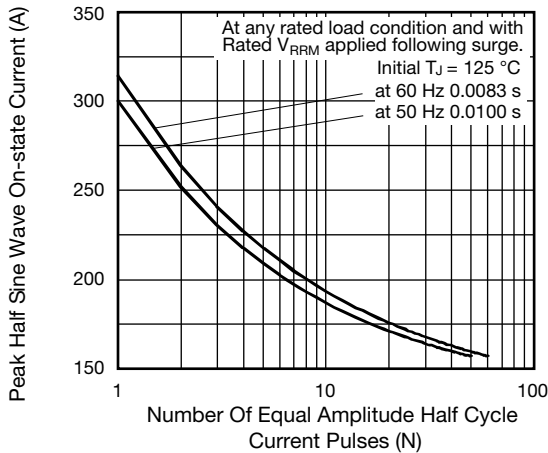

Fig. 5 - Maximum Non-Repetitive Surge Current

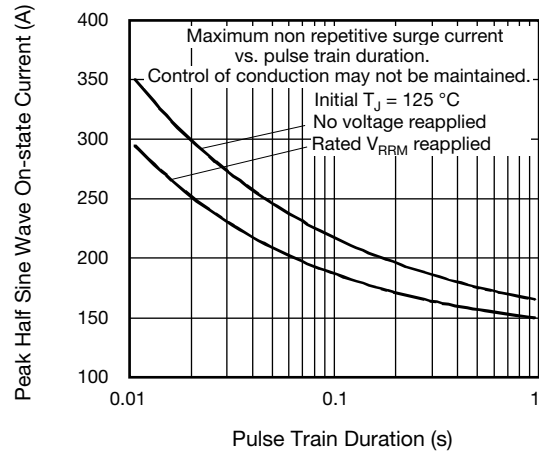

Fig. 6 - Maximum Non-Repetitive Surge Current

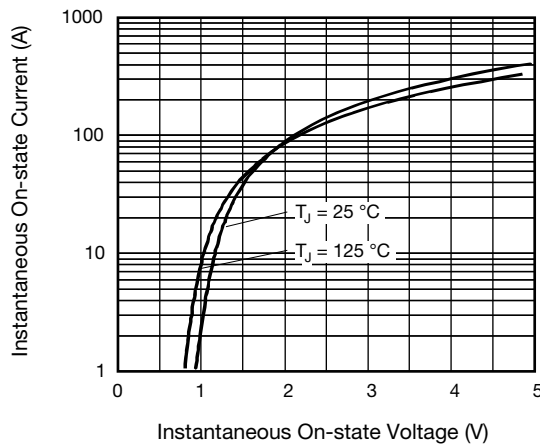

Fig. 7 - On-State Voltage Drop Characteristics

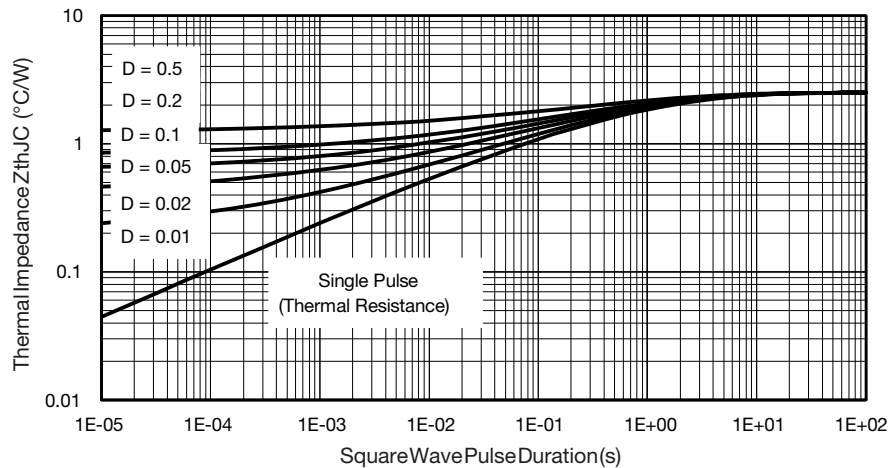

Fig. 8 - Thermal Impedance  $Z_{thJC}$  Characteristics

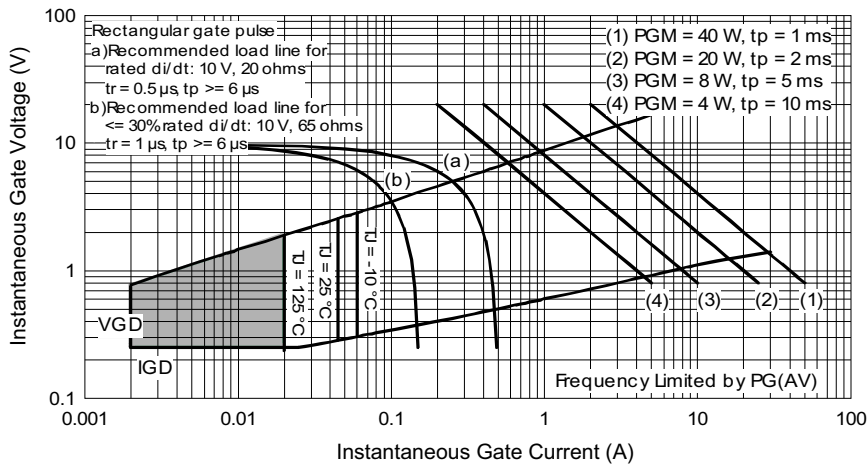

Fig. 9 - Gate Characteristics

**ORDERING INFORMATION TABLE**

Device code	<b>VS-</b>	<b>25</b>	<b>T</b>	<b>T</b>	<b>S</b>	<b>12</b>	<b>FP</b>	<b>-M3</b>
	①	②	③	④	⑤	⑥	⑦	⑧

- 1** - Vishay Semiconductors product
- 2** - Current rating (25 = 25 A)
- 3** - Circuit configuration:  
T = single thyristor
- 4** - Package:  
T = TO-220AB
- 5** - Type of silicon:  
Standard recovery rectifier
- 6** - Voltage code x 100 =  $V_{RRM}$  ——— 08 = 800 V  
12 = 1200 V
- 7** - FullPAK
- 8** - Environmental digit:  
-M3 = halogen-free, RoHS-compliant, and terminations lead (Pb)-free

<b>ORDERING INFORMATION (Example)</b>			
PREFERRED P/N	QUANTITY PER T/R	MINIMUM ORDER QUANTITY	PACKAGING DESCRIPTION
VS-25TTS08FP-M3	50	1000	Antistatic plastic tubes
VS-25TTS12FP-M3	50	1000	Antistatic plastic tubes

<b>LINKS TO RELATED DOCUMENTS</b>	
Dimensions	<a href="http://www.vishay.com/doc?96155">www.vishay.com/doc?96155</a>
Part marking information	<a href="http://www.vishay.com/doc?95456">www.vishay.com/doc?95456</a>



## 3L TO-220 FullPAK

**DIMENSIONS** in millimeters

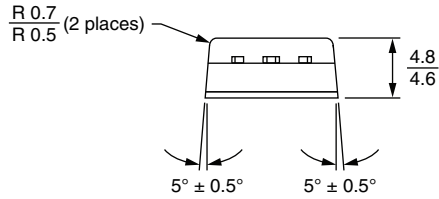
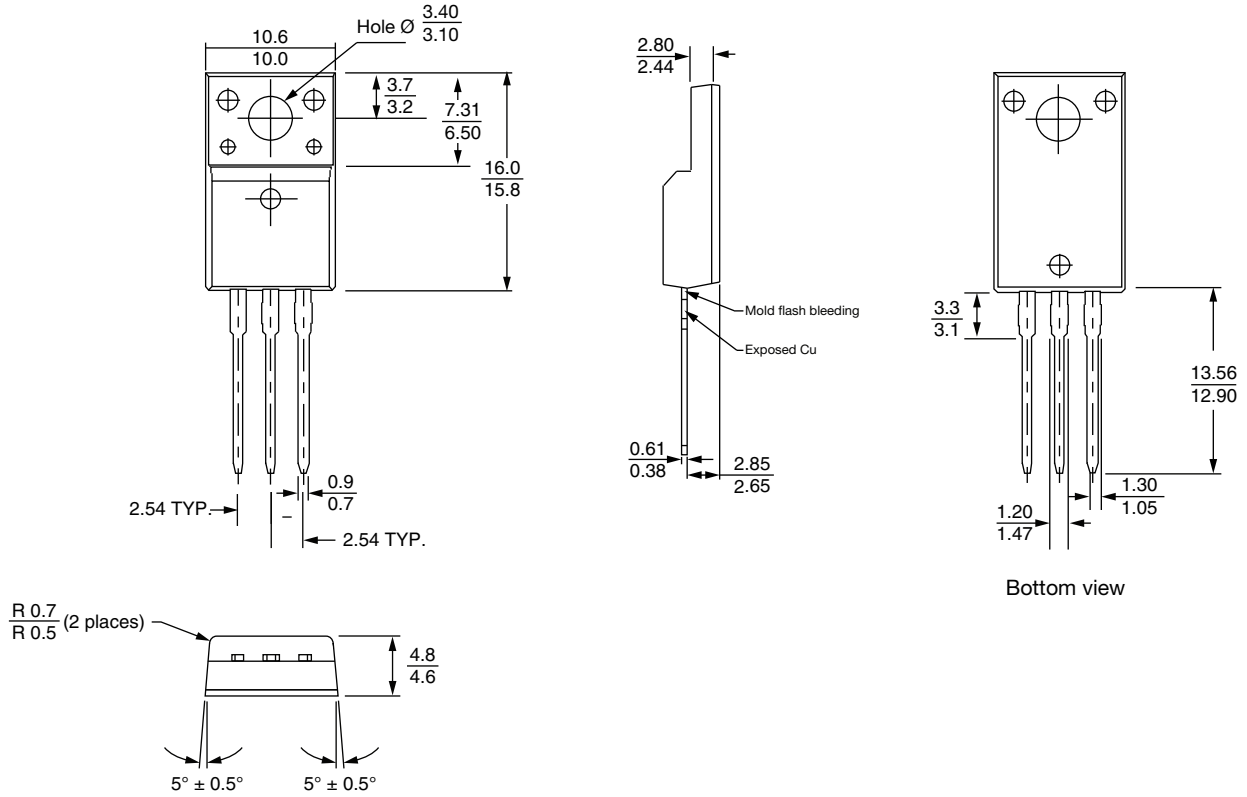

### Notes

- (1) All dimensions are in mm
- (2) Package body size exclude mold flash and burrs. Moldflash should be less than 6 mils



## **Disclaimer**

ALL PRODUCT, PRODUCT SPECIFICATIONS AND DATA ARE SUBJECT TO CHANGE WITHOUT NOTICE TO IMPROVE RELIABILITY, FUNCTION OR DESIGN OR OTHERWISE.

Vishay Intertechnology, Inc., its affiliates, agents, and employees, and all persons acting on its or their behalf (collectively, "Vishay"), disclaim any and all liability for any errors, inaccuracies or incompleteness contained in any datasheet or in any other disclosure relating to any product.

Vishay makes no warranty, representation or guarantee regarding the suitability of the products for any particular purpose or the continuing production of any product. To the maximum extent permitted by applicable law, Vishay disclaims (i) any and all liability arising out of the application or use of any product, (ii) any and all liability, including without limitation special, consequential or incidental damages, and (iii) any and all implied warranties, including warranties of fitness for particular purpose, non-infringement and merchantability.

Statements regarding the suitability of products for certain types of applications are based on Vishay's knowledge of typical requirements that are often placed on Vishay products in generic applications. Such statements are not binding statements about the suitability of products for a particular application. It is the customer's responsibility to validate that a particular product with the properties described in the product specification is suitable for use in a particular application. Parameters provided in datasheets and / or specifications may vary in different applications and performance may vary over time. All operating parameters, including typical parameters, must be validated for each customer application by the customer's technical experts. Product specifications do not expand or otherwise modify Vishay's terms and conditions of purchase, including but not limited to the warranty expressed therein.

Except as expressly indicated in writing, Vishay products are not designed for use in medical, life-saving, or life-sustaining applications or for any other application in which the failure of the Vishay product could result in personal injury or death. Customers using or selling Vishay products not expressly indicated for use in such applications do so at their own risk. Please contact authorized Vishay personnel to obtain written terms and conditions regarding products designed for such applications.

No license, express or implied, by estoppel or otherwise, to any intellectual property rights is granted by this document or by any conduct of Vishay. Product names and markings noted herein may be trademarks of their respective owners.