



Chipsmall Limited consists of a professional team with an average of over 10 year of expertise in the distribution of electronic components. Based in Hongkong, we have already established firm and mutual-benefit business relationships with customers from,Europe,America and south Asia,supplying obsolete and hard-to-find components to meet their specific needs.

With the principle of “Quality Parts,Customers Priority,Honest Operation,and Considerate Service”,our business mainly focus on the distribution of electronic components. Line cards we deal with include Microchip,ALPS,ROHM,Xilinx,Pulse,ON,Everlight and Freescale. Main products comprise IC,Modules,Potentiometer,IC Socket,Relay,Connector.Our parts cover such applications as commercial,industrial, and automotives areas.

We are looking forward to setting up business relationship with you and hope to provide you with the best service and solution. Let us make a better world for our industry!



Contact us

Tel: +86-755-8981 8866 Fax: +86-755-8427 6832

Email & Skype: info@chipsmall.com Web: www.chipsmall.com

Address: A1208, Overseas Decoration Building, #122 Zhenhua RD., Futian, Shenzhen, China





Schottky Rectifier, 3.3 A

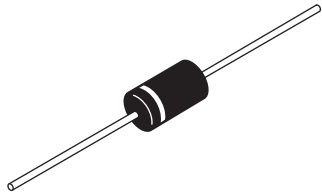

C-16



FEATURES

- Low profile, axial leaded outline
- High frequency operation
- Very low forward voltage drop
- High purity, high temperature epoxy encapsulation for enhanced mechanical strength and moisture resistance
- Guard ring for enhanced ruggedness and long term reliability
- Compliant to RoHS Directive 2002/95/EC
- Designed and qualified for commercial level
- Halogen-free according to IEC 61249-2-21 definition (-M3 only)



PRODUCT SUMMARY	
Package	DO-201AD (C-16)
$I_{F(AV)}$	3.3 A
V_R	90 V, 100 V
V_F at I_F	See Electrical table
I_{RM} max.	3.0 mA at 125 °C
T_J max.	150 °C
Diode variation	Single die
E_{AS}	3.0 mJ

DESCRIPTION

The VS-31DQ... axial leaded Schottky rectifier has been optimized for very low forward voltage drop, with moderate leakage. Typical applications are in switching power supplies, converters, freewheeling diodes, and reverse battery protection

MAJOR RATINGS AND CHARACTERISTICS			
SYMBOL	CHARACTERISTICS	VALUES	UNITS
$I_{F(AV)}$	Rectangular waveform	3.3	A
V_{RRM}		90/100	V
I_{FSM}	$t_p = 5 \mu s$ sine	210	A
V_F	3 Apk, $T_J = 25 \text{ }^\circ\text{C}$	0.85	V
T_J		- 40 to 150	°C

VOLTAGE RATINGS						
PARAMETER	SYMBOL	VS-31DQ09	VS-31DQ09-M3	VS-31DQ10	VS-31DQ10-M3	UNITS
Maximum DC reverse voltage	V_R	90	90	100	100	V
Maximum working peak reverse voltage	V_{RWM}					

ABSOLUTE MAXIMUM RATINGS					
PARAMETER	SYMBOL	TEST CONDITIONS		VALUES	UNITS
Maximum average forward current See fig. 4	$I_{F(AV)}$	50 % duty cycle at $T_L = 108 \text{ }^\circ\text{C}$, rectangular waveform		3.3	A
Maximum peak one cycle non-repetitive surge current See fig. 6	I_{FSM}	5 μs sine or 3 μs rect. pulse	Following any rated load condition and with rated V_{RRM} applied	210	
		10 ms sine or 6 ms rect. pulse		34	
Non-repetitive avalanche energy	E_{AS}	$T_J = 25 \text{ }^\circ\text{C}$, $I_{AS} = 1 \text{ A}$, $L = 6 \text{ mH}$		3.0	mJ
Repetitive avalanche current	I_{AR}	Current decaying linearly to zero in 1 μs Frequency limited by T_J maximum $V_A = 1.5 \times V_R$ typical		0.5	A



ELECTRICAL SPECIFICATIONS					
PARAMETER	SYMBOL	TEST CONDITIONS		VALUES	UNITS
Maximum forward voltage drop See fig. 1	$V_{FM}^{(1)}$	3 A	$T_J = 25\text{ }^\circ\text{C}$	0.85	V
		6 A		0.97	
		3 A	$T_J = 125\text{ }^\circ\text{C}$	0.69	
		6 A		0.80	
Maximum reverse leakage current See fig. 4	$I_{RM}^{(1)}$	$T_J = 25\text{ }^\circ\text{C}$	$V_R = \text{Rated } V_R$	1	mA
		$T_J = 125\text{ }^\circ\text{C}$		3	
Typical junction capacitance	C_T	$V_R = 5 V_{DC}$ (test signal range 100 kHz to 1 MHz) $25\text{ }^\circ\text{C}$		110	pF
Typical series inductance	L_S	Measured lead to lead 5 mm from package body		9.0	nH
Maximum voltage rate of charge	dV/dt	Rated V_R		10 000	V/ μs

Note(1) Pulse width < 300 μs , duty cycle < 2 %

THERMAL - MECHANICAL SPECIFICATIONS					
PARAMETER	SYMBOL	TEST CONDITIONS		VALUES	UNITS
Maximum junction and storage temperature range	$T_J^{(1)}, T_{Stg}$			- 40 to 150	$^\circ\text{C}$
Maximum thermal resistance, junction to ambient	R_{thJA}	DC operation Without cooling fin		80	$^\circ\text{C/W}$
Typical thermal resistance, junction to lead	R_{thJL}	DC operation		15	
Approximate weight				1.2	g
				0.042	oz.
Marking device		Case style C-16		31DQ09	
				31DQ10	

Note(1) $\frac{dP_{tot}}{dT_J} < \frac{1}{R_{thJA}}$ thermal runaway condition for a diode on its own heatsink

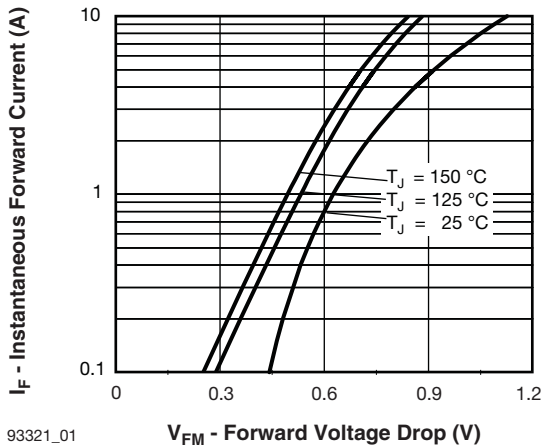

93321_01 **V_{FM} - Forward Voltage Drop (V)**
Fig. 1 - Maximum Forward Voltage Drop Characteristics

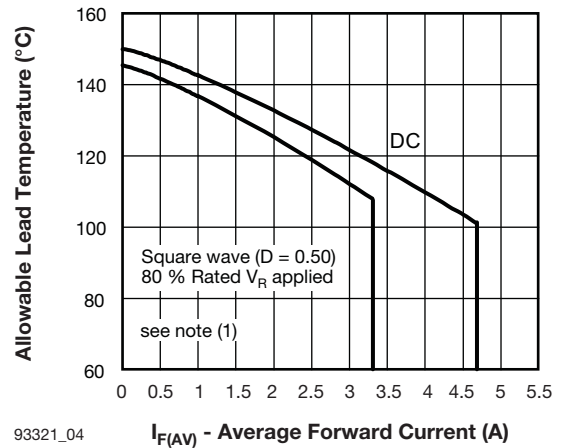

93321_04 **I_{F(AV)} - Average Forward Current (A)**
Fig. 4 - Maximum Allowable Lead Temperature vs. Average Forward Current

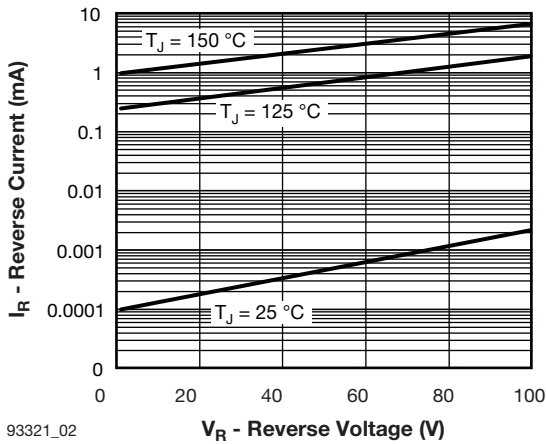

93321_02 **V_R - Reverse Voltage (V)**
Fig. 2 - Typical Values of Reverse Current vs. Reverse Voltage

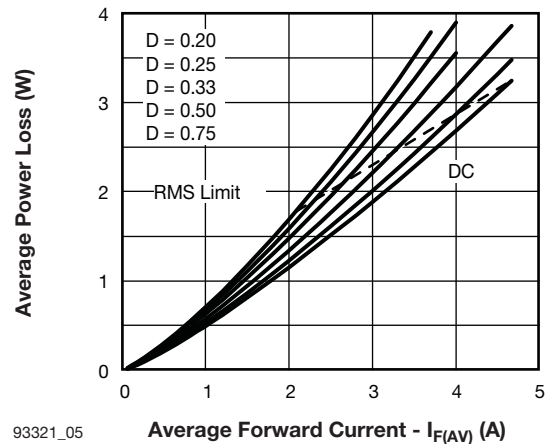

93321_05 **Average Forward Current - I_{F(AV)} (A)**
Fig. 5 - Forward Power Loss Characteristics

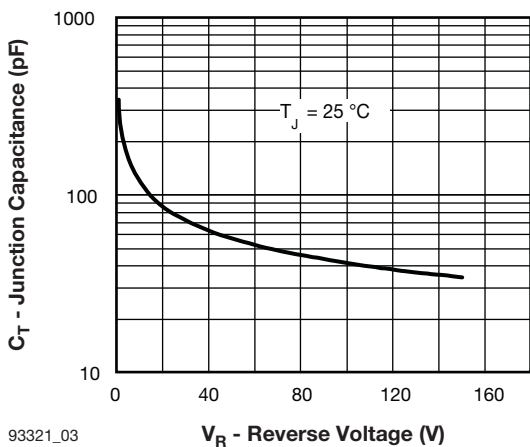

93321_03 **V_R - Reverse Voltage (V)**
Fig. 3 - Typical Junction Capacitance vs. Reverse Voltage

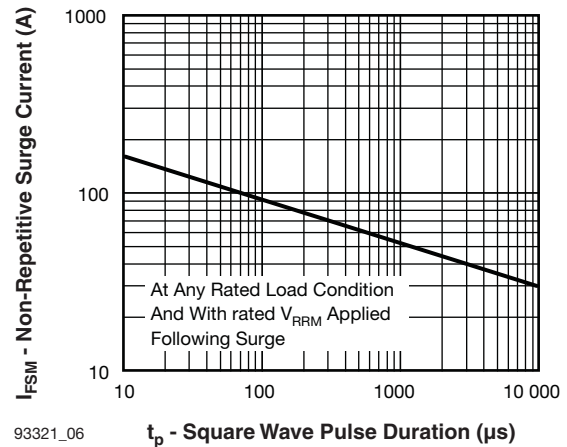

93321_06 **t_p - Square Wave Pulse Duration (μs)**
Fig. 6 - Maximum Non-Repetitive Surge Current

Note

- (1) Formula used: $T_C = T_J - (P_d + P_{dREV}) \times R_{thJL}$;
 $P_d = \text{Forward power loss} = I_{F(AV)} \times V_{FM}$ at $(I_{F(AV)}/D)$ (see fig. 6); $P_{dREV} = \text{Inverse power loss} = V_{R1} \times I_R (1 - D)$; I_R at $V_{R1} = 80\%$ rated V_R



ORDERING INFORMATION TABLE

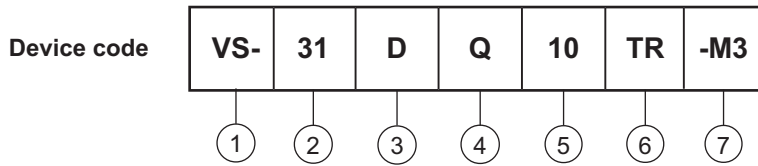

- 1** - Vishay Semiconductors product
- 2** - 31 = Current Rating, 3.3 A
- 3** - D = DO-201 package
- 4** - Q = Schottky Q.. series
- 5** - 10 = Voltage ratings 09 = 90 V
10 = 100 V
- 6** -
 - TR = Tape and reel package
 - None = Bulk package
- 7** - Environmental digit
 - None = Lead (Pb)-free and RoHS compliant
 - -M3 = Halogen-free, RoHS compliant, and terminations lead (Pb)-free

ORDERING INFORMATION (Example)			
PREFERRED P/N	QUANTITY PER T/R	MINIMUM ORDER QUANTITY	PACKAGING DESCRIPTION
VS-31DQ09	500	500	Bulk
VS-31DQ09TR	1200	1200	Tape and reel
VS-31DQ09-M3	500	500	Bulk
VS-31DQ09TR-M3	1200	1200	Tape and reel
VS-31DQ10	500	500	Bulk
VS-31DQ10TR	1200	1200	Tape and reel
VS-31DQ10-M3	500	500	Bulk
VS-31DQ10TR-M3	1200	1200	Tape and reel

LINKS TO RELATED DOCUMENTS	
Dimensions	www.vishay.com/doc?95242
Part marking information	www.vishay.com/doc?95304
Packaging information	www.vishay.com/doc?95338
SPICE model	www.vishay.com/doc?95300



Axial DO-201AD (C-16)

DIMENSIONS in millimeters (inches)

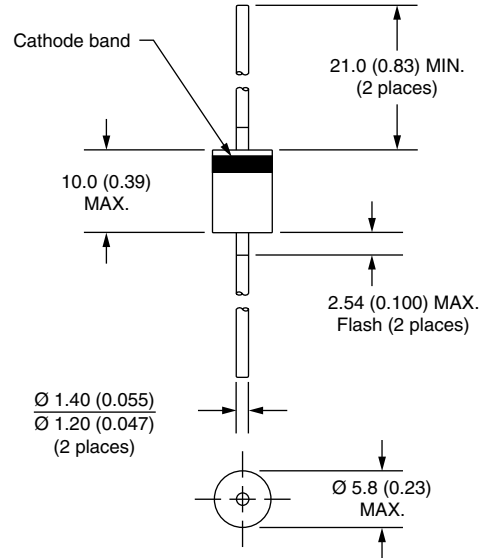
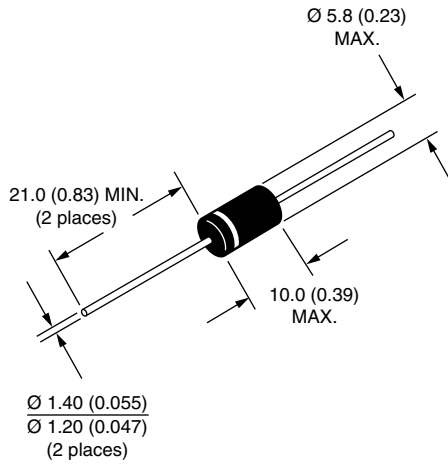



Disclaimer

ALL PRODUCT, PRODUCT SPECIFICATIONS AND DATA ARE SUBJECT TO CHANGE WITHOUT NOTICE TO IMPROVE RELIABILITY, FUNCTION OR DESIGN OR OTHERWISE.

Vishay Intertechnology, Inc., its affiliates, agents, and employees, and all persons acting on its or their behalf (collectively, "Vishay"), disclaim any and all liability for any errors, inaccuracies or incompleteness contained in any datasheet or in any other disclosure relating to any product.

Vishay makes no warranty, representation or guarantee regarding the suitability of the products for any particular purpose or the continuing production of any product. To the maximum extent permitted by applicable law, Vishay disclaims (i) any and all liability arising out of the application or use of any product, (ii) any and all liability, including without limitation special, consequential or incidental damages, and (iii) any and all implied warranties, including warranties of fitness for particular purpose, non-infringement and merchantability.

Statements regarding the suitability of products for certain types of applications are based on Vishay's knowledge of typical requirements that are often placed on Vishay products in generic applications. Such statements are not binding statements about the suitability of products for a particular application. It is the customer's responsibility to validate that a particular product with the properties described in the product specification is suitable for use in a particular application. Parameters provided in datasheets and/or specifications may vary in different applications and performance may vary over time. All operating parameters, including typical parameters, must be validated for each customer application by the customer's technical experts. Product specifications do not expand or otherwise modify Vishay's terms and conditions of purchase, including but not limited to the warranty expressed therein.

Except as expressly indicated in writing, Vishay products are not designed for use in medical, life-saving, or life-sustaining applications or for any other application in which the failure of the Vishay product could result in personal injury or death. Customers using or selling Vishay products not expressly indicated for use in such applications do so at their own risk. Please contact authorized Vishay personnel to obtain written terms and conditions regarding products designed for such applications.

No license, express or implied, by estoppel or otherwise, to any intellectual property rights is granted by this document or by any conduct of Vishay. Product names and markings noted herein may be trademarks of their respective owners.

Material Category Policy

Vishay Intertechnology, Inc. hereby certifies that all its products that are identified as RoHS-Compliant fulfill the definitions and restrictions defined under Directive 2011/65/EU of The European Parliament and of the Council of June 8, 2011 on the restriction of the use of certain hazardous substances in electrical and electronic equipment (EEE) - recast, unless otherwise specified as non-compliant.

Please note that some Vishay documentation may still make reference to RoHS Directive 2002/95/EC. We confirm that all the products identified as being compliant to Directive 2002/95/EC conform to Directive 2011/65/EU.

Vishay Intertechnology, Inc. hereby certifies that all its products that are identified as Halogen-Free follow Halogen-Free requirements as per JEDEC JS709A standards. Please note that some Vishay documentation may still make reference to the IEC 61249-2-21 definition. We confirm that all the products identified as being compliant to IEC 61249-2-21 conform to JEDEC JS709A standards.