



Chipsmall Limited consists of a professional team with an average of over 10 year of expertise in the distribution of electronic components. Based in Hongkong, we have already established firm and mutual-benefit business relationships with customers from,Europe,America and south Asia,supplying obsolete and hard-to-find components to meet their specific needs.

With the principle of “Quality Parts,Customers Priority,Honest Operation,and Considerate Service”,our business mainly focus on the distribution of electronic components. Line cards we deal with include Microchip,ALPS,ROHM,Xilinx,Pulse,ON,Everlight and Freescale. Main products comprise IC,Modules,Potentiometer,IC Socket,Relay,Connector.Our parts cover such applications as commercial,industrial, and automotives areas.

We are looking forward to setting up business relationship with you and hope to provide you with the best service and solution. Let us make a better world for our industry!



Contact us

Tel: +86-755-8981 8866 Fax: +86-755-8427 6832

Email & Skype: info@chipsmall.com Web: www.chipsmall.com

Address: A1208, Overseas Decoration Building, #122 Zhenhua RD., Futian, Shenzhen, China



Medium Power Phase Control Thyristors (Stud Version), 50 A



TO-208AC (TO-65)

FEATURES

- High current rating
- Excellent dynamic characteristics
- $dV/dt = 1000 \text{ V}/\mu\text{s}$ option
- Superior surge capabilities
- Standard package
- Metric threads version available
- Types up to 1200 V $V_{\text{DRM}}/V_{\text{RRM}}$
- Material categorization: for definitions of compliance please see www.vishay.com/doc?99912



RoHS
COMPLIANT

| PRODUCT SUMMARY | |
|---------------------------------|------------------|
| Package | TO-208AC (TO-65) |
| Diode variation | Single SCR |
| $I_{\text{T(AV)}}$ | 50 A |
| $V_{\text{DRM}}/V_{\text{RRM}}$ | 100 V to 1200 V |
| V_{TM} | 1.60 V |
| I_{GT} | 100 mA |
| T_{J} | -40 °C to 125 °C |

TYPICAL APPLICATIONS

- Phase control applications in converters
- Lighting circuits
- Battery charges
- Regulated power supplies and temperature and speed control circuit

| MAJOR RATINGS AND CHARACTERISTICS | | | |
|-----------------------------------|-----------------|-------------|-------------------|
| PARAMETER | TEST CONDITIONS | VALUES | UNITS |
| $I_{\text{T(AV)}}$ | | 50 | A |
| | T_{C} | 94 | °C |
| $I_{\text{T(RMS)}}$ | | 80 | A |
| I_{TSM} | 50 Hz | 1430 | A |
| | 60 Hz | 1490 | |
| I^2t | 50 Hz | 10.18 | kA ² s |
| | 60 Hz | 9.30 | |
| $V_{\text{DRM}}/V_{\text{RRM}}$ | | 100 to 1200 | V |
| t_{q} | Typical | 110 | μs |
| T_{J} | | -40 to +125 | °C |

ELECTRICAL SPECIFICATIONS

| VOLTAGE RATINGS | | | | |
|-----------------|--------------|---|--|--|
| TYPE NUMBER | VOLTAGE CODE | $V_{\text{DRM}}/V_{\text{RRM}}$, MAXIMUM REPETITIVE PEAK AND OFF-STATE VOLTAGE ⁽¹⁾ V | V_{RSM} , MAXIMUM NON-REPETITIVE PEAK VOLTAGE ⁽²⁾ V | $I_{\text{DRM}}/I_{\text{RRM}}$ MAXIMUM AT $T_{\text{J}} = T_{\text{J}}$ MAXIMUM mA |
| VS-50RIA | 10 | 100 | 150 | 15 |
| | 20 | 200 | 300 | |
| | 40 | 400 | 500 | |
| | 60 | 600 | 700 | |
| | 80 | 800 | 900 | |
| | 100 | 1000 | 1100 | |
| | 120 | 1200 | 1300 | |

Notes

- (1) Units may be broken over non-repetitively in the off-state direction without damage, if dI/dt does not exceed 20 A/ μs
- (2) For voltage pulses with $t_{\text{p}} \leq 5 \text{ ms}$



| ABSOLUTE MAXIMUM RATINGS | | | | | |
|--|---------------|--|----------------------------|---|--------------------|
| PARAMETER | SYMBOL | TEST CONDITIONS | | VALUES | UNITS |
| Maximum average on-state current at case temperature | $I_{T(AV)}$ | 180° sinusoidal conduction | | 50 | A |
| | | | | 94 | °C |
| Maximum RMS on-state current | $I_{T(RMS)}$ | | | 80 | A |
| Maximum peak, one-cycle non-repetitive surge current | I_{TSM} | t = 10 ms | No voltage reappplied | Sinusoidal half wave, initial $T_J = T_J$ maximum | A |
| | | t = 8.3 ms | | | |
| | | t = 10 ms | 100 % V_{RRM} reappplied | | |
| | | t = 8.3 ms | | | |
| Maximum I^2t for fusing | I^2t | t = 10 ms | No voltage reappplied | | kA ² s |
| | | t = 8.3 ms | | | |
| | | t = 10 ms | 100 % V_{RRM} reappplied | | |
| | | t = 8.3 ms | | | |
| Maximum $I^2\sqrt{t}$ for fusing | $I^2\sqrt{t}$ | t = 0.1 to 10 ms, no voltage reappplied, $T_J = T_J$ maximum | | 101.8 | kA ² √s |
| Low level value of threshold voltage | $V_{T(TO)1}$ | $(16.7 \% \times \pi \times I_{T(AV)} < I < \pi \times I_{T(AV)})$, $T_J = T_J$ maximum | | 0.94 | V |
| High level value of threshold voltage | $V_{T(TO)2}$ | $(\pi \times I_{T(AV)} < I < 20 \times \pi \times I_{T(AV)})$, $T_J = T_J$ maximum | | 1.08 | |
| Low level value of on-state slope resistance | r_{t1} | $(16.7 \% \times \pi \times I_{T(AV)} < I < \pi \times I_{T(AV)})$, $T_J = T_J$ maximum | | 4.08 | mΩ |
| High level value of on-state slope resistance | r_{t2} | $(\pi \times I_{T(AV)} < I < 20 \times \pi \times I_{T(AV)})$, $T_J = T_J$ maximum | | 3.34 | |
| Maximum on-state voltage | V_{TM} | $I_{pk} = 157$ A, $T_J = 25$ °C | | 1.60 | V |
| Maximum holding current | I_H | $T_J = 25$ °C, anode supply 22 V, resistive load, initial $I_T = 2$ A | | 200 | mA |
| Latching current | I_L | Anode supply 6 V, resistive load | | 400 | |

| SWITCHING | | | | | |
|---|--------|---|--|----------------------|-------|
| PARAMETER | SYMBOL | TEST CONDITIONS | | VALUES | UNITS |
| Maximum rate of rise of turned-on current | dI/dt | $T_C = 125$ °C, $V_{DM} =$ Rated V_{DRM} , Gate pulse = 20 V, 15 Ω, $t_p = 6$ μs, $t_r = 0.1$ μs maximum $I_{TM} = (2 \times \text{rated } dI/dt)$ A | | 200 | A/μs |
| | | | | $V_{DRM} \leq 600$ V | |
| Typical delay time | t_d | $T_C = 25$ °C, $V_{DM} =$ Rated V_{DRM} , $I_{TM} = 10$ A dc resistive circuit Gate pulse = 10 V, 15 Ω source, $t_p = 20$ μs | | 0.9 | μs |
| Typical turn-off time | t_q | $T_C = 125$ °C, $I_{TM} = 50$ A, reappplied $dV/dt = 20$ V/μs $dI_r/dt = -10$ A/μs, $V_R = 50$ V | | 110 | |

| BLOCKING | | | | | |
|--|--------|---|--|--------------------|-------|
| PARAMETER | SYMBOL | TEST CONDITIONS | | VALUES | UNITS |
| Maximum critical rate of rise of off-state voltage | dV/dt | $T_J = T_J$ maximum linear to 100 % rated V_{DRM} | | 200 | V/μs |
| | | $T_J = T_J$ maximum linear to 67 % rated V_{DRM} | | 500 ⁽¹⁾ | |

Note

⁽¹⁾ Available with $dV/dt = 1000$ V/μs, to complete code add S90 i.e. 50RIA120S90



| TRIGGERING | | | | | |
|-------------------------------------|-------------|--|--|--|-------|
| PARAMETER | SYMBOL | TEST CONDITIONS | | VALUES | UNITS |
| Maximum peak gate power | P_{GM} | $T_J = T_J$ maximum, $t_p \leq 5$ ms | | 10 | W |
| Maximum average gate power | $P_{G(AV)}$ | | | 2.5 | |
| Maximum peak positive gate current | I_{GM} | | | 2.5 | A |
| Maximum peak positive gate voltage | $+V_{GM}$ | | | 20 | V |
| Maximum peak negative gate voltage | $-V_{GM}$ | | | 10 | |
| DC gate current required to trigger | I_{GT} | $T_J = -40$ °C | Maximum required gate trigger current/voltage are the lowest value which will trigger all units 6 V anode to cathode applied | 250 | mA |
| | | $T_J = 25$ °C | | 100 | |
| | | $T_J = 125$ °C | | 50 | |
| DC gate voltage required to trigger | V_{GT} | $T_J = -40$ °C | | 3.5 | V |
| | | $T_J = 25$ °C | | 2.5 | |
| DC gate current not to trigger | I_{GD} | $T_J = T_J$ maximum, $V_{DRM} =$ Rated voltage | | Maximum gate current/voltage not to trigger is the maximum value which will not trigger any unit with rated V_{DRM} anode to cathode applied | 5.0 |
| DC gate voltage not to trigger | V_{GD} | $T_J = T_J$ maximum | 0.2 | | V |

| THERMAL AND MECHANICAL SPECIFICATIONS | | | | | |
|--|----------------|---|--|------------------------|--------------------|
| PARAMETER | SYMBOL | TEST CONDITIONS | | VALUES | UNITS |
| Maximum operating junction and storage temperature range | T_J, T_{Stg} | | | -40 to +125 | °C |
| Maximum thermal resistance, junction to case | R_{thJC} | DC operation | | 0.35 | K/W |
| Maximum thermal resistance, case to heat sink | R_{thCS} | Mounting surface, smooth, flat and greased | | 0.25 | |
| Allowable mounting torque | | Non-lubricated threads | | 3.4 + 0 - 10 % (30) | N · m (lb · in) |
| | | Lubricated threads | | 2.3 + 0 - 10 % (20) | |
| Approximate weight | | | | 28 | g |
| | | | | 1.0 | oz. |
| Case style | | See dimensions - link at the end of datasheet | | TO-208AC (TO-65) | |

| ΔR_{thJC} CONDUCTION | | | | |
|--|-----------------------|------------------------|---------------------|-------|
| CONDUCTION ANGLE | SINUSOIDAL CONDUCTION | RECTANGULAR CONDUCTION | TEST CONDITIONS | UNITS |
| 180° | 0.078 | 0.057 | $T_J = T_J$ maximum | K/W |
| 120° | 0.094 | 0.098 | | |
| 90° | 0.120 | 0.130 | | |
| 60° | 0.176 | 0.183 | | |
| 30° | 0.294 | 0.296 | | |

Note

- The table above shows the increment of thermal resistance R_{thJC} when devices operate at different conduction angles than DC

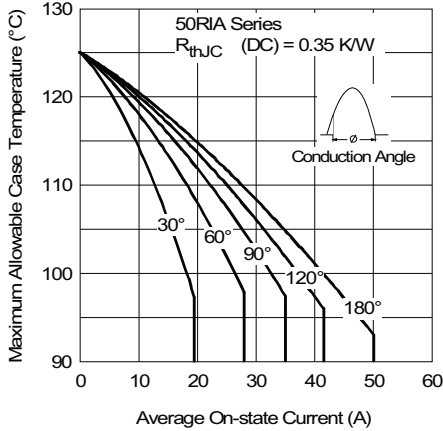

Fig. 1 - Current Ratings Characteristics

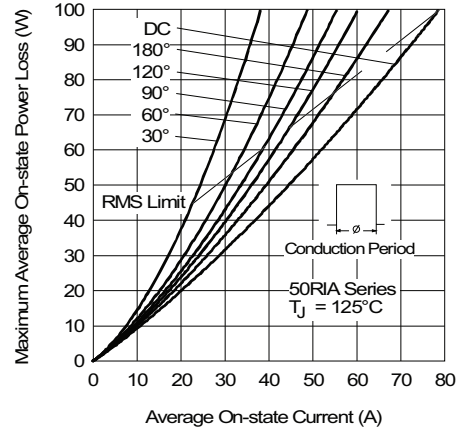

Fig. 4 - On-State Power Loss Characteristics

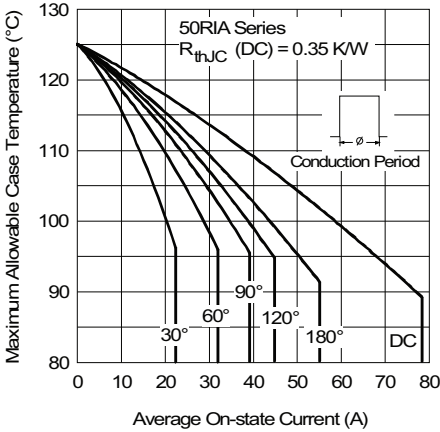

Fig. 2 - Current Ratings Characteristics

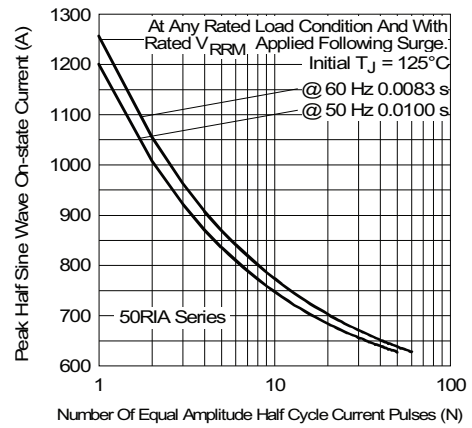

Fig. 5 - Maximum Non-Repetitive Surge Current

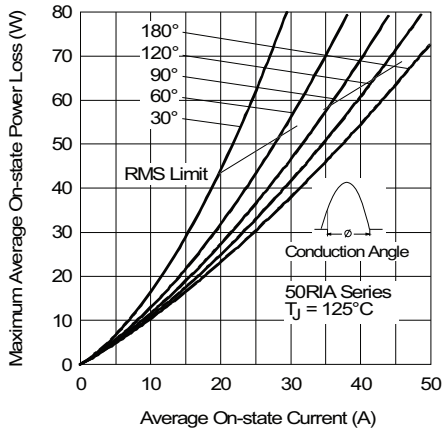

Fig. 3 - On-State Power Loss Characteristics

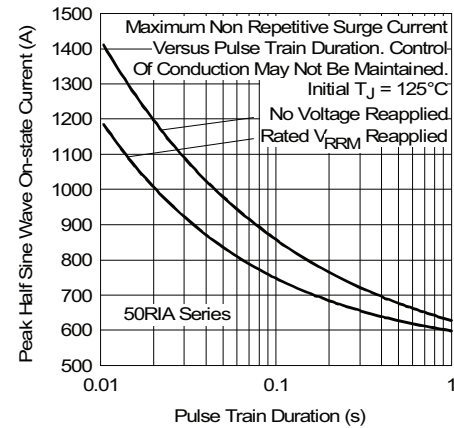

Fig. 6 - Maximum Non-Repetitive Surge Current

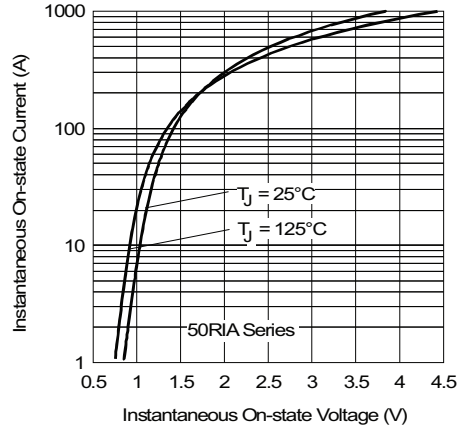

Fig. 7 - Forward Voltage Drop Characteristics

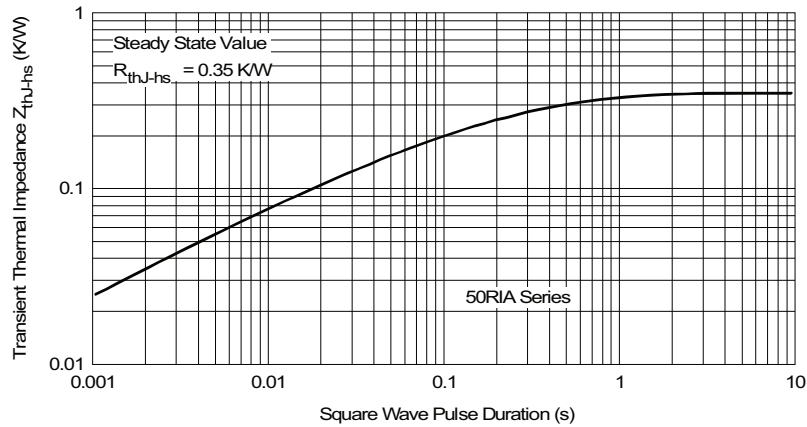

Fig. 8 - Thermal Impedance Z_{thJc} Characteristics

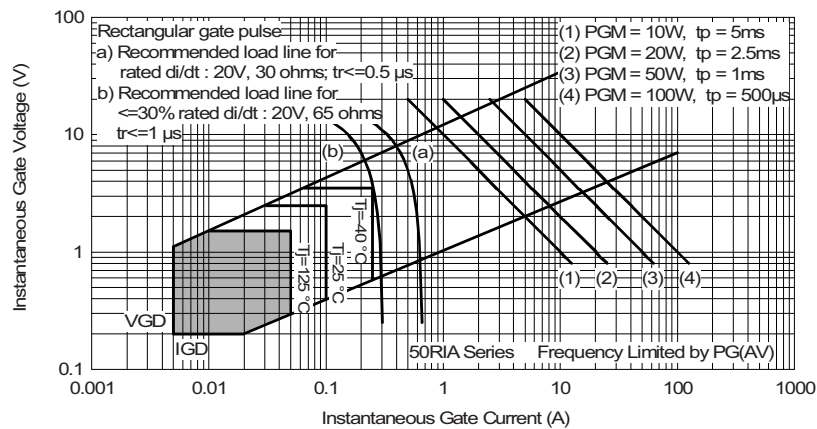
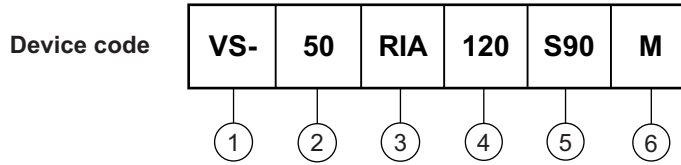

Fig. 9 - Gate Characteristics



ORDERING INFORMATION TABLE



- 1** - Vishay Semiconductors product
- 2** - Current code
- 3** - Essential part number
- 4** - Voltage code x 10 = V_{RRM} (see Voltage Ratings table)
- 5** - Critical dV/dt:
 - None = 500 V/ μ s (standard value)
 - S90 = 1000 V/ μ s (special selection)
- 6** -
 - None = Stud base TO-208AC (TO-65) 1/4" 28UNF-2A
 - M = Stud base TO-208AC (TO-65) M6 x 1

| LINKS TO RELATED DOCUMENTS | |
|----------------------------|--|
| Dimensions | www.vishay.com/doc?95334 |



TO-208AC (TO-65)

DIMENSIONS in millimeters (inches)

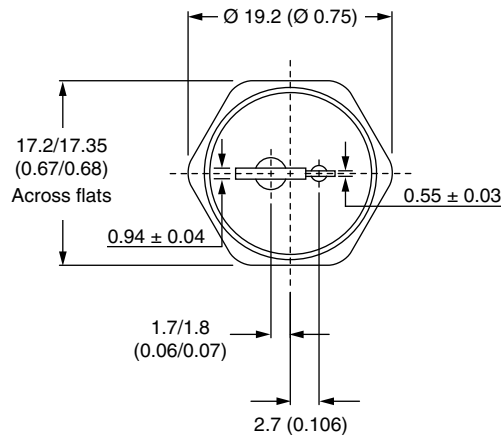
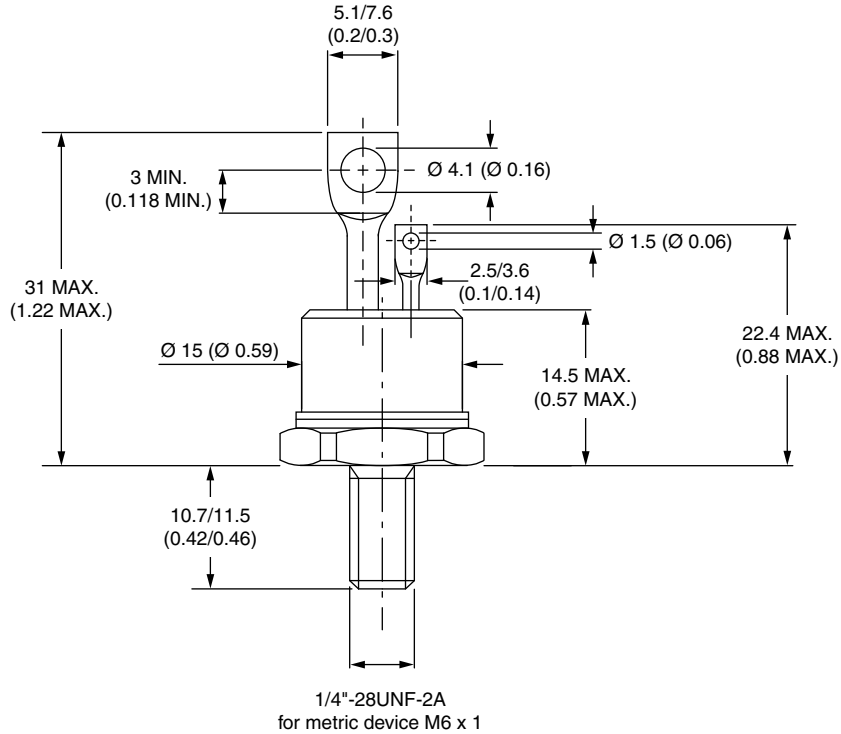



Disclaimer

ALL PRODUCT, PRODUCT SPECIFICATIONS AND DATA ARE SUBJECT TO CHANGE WITHOUT NOTICE TO IMPROVE RELIABILITY, FUNCTION OR DESIGN OR OTHERWISE.

Vishay Intertechnology, Inc., its affiliates, agents, and employees, and all persons acting on its or their behalf (collectively, "Vishay"), disclaim any and all liability for any errors, inaccuracies or incompleteness contained in any datasheet or in any other disclosure relating to any product.

Vishay makes no warranty, representation or guarantee regarding the suitability of the products for any particular purpose or the continuing production of any product. To the maximum extent permitted by applicable law, Vishay disclaims (i) any and all liability arising out of the application or use of any product, (ii) any and all liability, including without limitation special, consequential or incidental damages, and (iii) any and all implied warranties, including warranties of fitness for particular purpose, non-infringement and merchantability.

Statements regarding the suitability of products for certain types of applications are based on Vishay's knowledge of typical requirements that are often placed on Vishay products in generic applications. Such statements are not binding statements about the suitability of products for a particular application. It is the customer's responsibility to validate that a particular product with the properties described in the product specification is suitable for use in a particular application. Parameters provided in datasheets and / or specifications may vary in different applications and performance may vary over time. All operating parameters, including typical parameters, must be validated for each customer application by the customer's technical experts. Product specifications do not expand or otherwise modify Vishay's terms and conditions of purchase, including but not limited to the warranty expressed therein.

Except as expressly indicated in writing, Vishay products are not designed for use in medical, life-saving, or life-sustaining applications or for any other application in which the failure of the Vishay product could result in personal injury or death. Customers using or selling Vishay products not expressly indicated for use in such applications do so at their own risk. Please contact authorized Vishay personnel to obtain written terms and conditions regarding products designed for such applications.

No license, express or implied, by estoppel or otherwise, to any intellectual property rights is granted by this document or by any conduct of Vishay. Product names and markings noted herein may be trademarks of their respective owners.