



Chipsmall Limited consists of a professional team with an average of over 10 year of expertise in the distribution of electronic components. Based in Hongkong, we have already established firm and mutual-benefit business relationships with customers from,Europe,America and south Asia,supplying obsolete and hard-to-find components to meet their specific needs.

With the principle of "Quality Parts,Customers Priority,Honest Operation,and Considerate Service",our business mainly focus on the distribution of electronic components. Line cards we deal with include Microchip,ALPS,ROHM,Xilinx,Pulse,ON,Everlight and Freescale. Main products comprise IC,Modules,Potentiometer,IC Socket,Relay,Connector.Our parts cover such applications as commercial,industrial, and automotives areas.

We are looking forward to setting up business relationship with you and hope to provide you with the best service and solution. Let us make a better world for our industry!



Contact us

Tel: +86-755-8981 8866 Fax: +86-755-8427 6832

Email & Skype: info@chipsmall.com Web: www.chipsmall.com

Address: A1208, Overseas Decoration Building, #122 Zhenhua RD., Futian, Shenzhen, China



EMIPAK-1B PressFit Power Module Neutral Point Clamp Topology, 30 A



EMIPAK-1B
(package example)

FEATURES

- Ultrafast Trench IGBT technology
- HEXFRED® and silicon carbide diode technology
- PressFit pins technology
- Exposed Al₂O₃ substrate with low thermal resistance
- Low internal inductances
- PressFit pins locking technology. Patent # US.263.820 B2
- UL approved file E78996
- Material categorization: for definitions of compliance please see www.vishay.com/doc?99912



RoHS
COMPLIANT

PRODUCT SUMMARY	
TRENCH IGBT 1200 V STAGE	
V _{CES}	1200 V
V _{CE(ON)} typical at I _C = 30 A	2.12 V
I _C at T _C = 102 °C	30 A
TRENCH IGBT 600 V STAGE	
V _{CES}	600 V
V _{CE(ON)} typical at I _C = 30 A	1.42 V
I _C at T _C = 106 °C	30 A
Speed	8 kHz to 30 kHz
Package	EMIPAK-1B
Circuit	3-levels neutral point clamp topology

DESCRIPTION

VS-ENQ030L120S is an integrated solution for a neutral point clamp topology in a single package. The EMIPAK-1B package is easy to use thanks to the PressFit pins and the exposed substrate provides improved thermal performance. The optimized layout also helps to minimize stray parameters, allowing for better EMI performance.

ABSOLUTE MAXIMUM RATINGS				
PARAMETER	SYMBOL	TEST CONDITIONS	MAX.	UNITS
Operating junction temperature	T _J		150	°C
Storage temperature range	T _{Stg}		-40 to +150	
RMS isolation voltage	V _{ISOL}	T _J = 25 °C, all terminals shorted, f = 50 Hz, t = 1 s	3500	V
Q1 - Q4 TRENCH IGBT 1200 V				
Collector to emitter voltage	V _{CES}		1200	V
Gate to emitter voltage	V _{GES}		± 30	
Pulsed collector current	I _{CM}		120	A
Clamped inductive load current	I _{LM} ⁽¹⁾		120	
Continuous drain current	I _C	T _C = 25 °C	61	A
		T _C = 80 °C	40	
		T _{SINK} = 80 °C	21	
Power dissipation	P _D	T _C = 25 °C	216	W
		T _C = 80 °C	121	

PATENT(S): www.vishay.com/patents

This Vishay product is protected by one or more United States and International patents.



ABSOLUTE MAXIMUM RATINGS				
PARAMETER	SYMBOL	TEST CONDITIONS	MAX.	UNITS
Q2 - Q3 TRENCH IGBT 600 V				
Collector to emitter voltage	V_{CES}		600	V
Gate to emitter voltage	V_{GES}		± 20	
Pulsed collector current	I_{CM}		130	A
Clamped inductive load current	$I_{LM}^{(2)}$		130	
Continuous collector current	I_C	$T_C = 25\text{ °C}$	64	A
		$T_C = 80\text{ °C}$	42	
		$T_{SINK} = 80\text{ °C}$	25	
Power dissipation	P_D	$T_C = 25\text{ °C}$	174	W
		$T_C = 80\text{ °C}$	97	
D1 - D4 HEXFRED ANTIPARALLEL DIODE				
Single pulse forward current	I_{FSM}	10 ms sine or 6 ms rectangular pulse, $T_J = 25\text{ °C}$	180	A
Diode continuous forward current	I_F	$T_C = 25\text{ °C}$	46	A
		$T_C = 80\text{ °C}$	30	
		$T_{SINK} = 80\text{ °C}$	17	
Power dissipation	P_D	$T_C = 25\text{ °C}$	187	W
		$T_C = 80\text{ °C}$	105	
D2 - D3 SILICON CARBIDE ANTIPARALLEL DIODE				
Single pulse forward current	I_{FSM}	10 ms sine or 6 ms rectangular pulse, $T_J = 25\text{ °C}$	150	A
Diode continuous forward current	I_F	$T_C = 25\text{ °C}$	40	A
		$T_C = 80\text{ °C}$	28	
		$T_{SINK} = 80\text{ °C}$	20	
Power dissipation	P_D	$T_C = 25\text{ °C}$	140	W
		$T_C = 80\text{ °C}$	79	

Notes

- Absolute Maximum Ratings indicate sustained limits beyond which damage to the device may occur.
- (1) $V_{CC} = 600\text{ V}$, $V_{GE} = 15\text{ V}$, $L = 500\text{ }\mu\text{H}$, $R_g = 4.7\text{ }\Omega$, $T_J = 150\text{ °C}$
- (2) $V_{CC} = 300\text{ V}$, $V_{GE} = 15\text{ V}$, $L = 500\text{ }\mu\text{H}$, $R_g = 4.7\text{ }\Omega$, $T_J = 150\text{ °C}$

ELECTRICAL SPECIFICATIONS ($T_J = 25\text{ °C}$ unless otherwise noted)						
PARAMETER	SYMBOL	TEST CONDITIONS	MIN.	TYP.	MAX.	UNITS
Q1 - Q4 TRENCH IGBT 1200 V						
Collector to emitter breakdown voltage	BV_{CES}	$V_{GE} = 0\text{ V}$, $I_C = 100\text{ }\mu\text{A}$	1200	-	-	V
Collector to emitter voltage	$V_{CE(ON)}$	$V_{GE} = 15\text{ V}$, $I_C = 30\text{ A}$	-	2.12	2.52	
		$V_{GE} = 15\text{ V}$, $I_C = 30\text{ A}$, $T_J = 125\text{ °C}$	-	2.31	-	
Gate threshold voltage	$V_{GE(th)}$	$V_{CE} = V_{GE}$, $I_C = 1.0\text{ mA}$	2.6	4.6	6.6	
Temperature coefficient of threshold voltage	$\Delta V_{GE(th)}/\Delta T_J$	$V_{CE} = V_{GE}$, $I_C = 1\text{ mA}$ (25 °C to 125 °C)	-	- 14	-	mV/°C
Forward transconductance	g_{fe}	$V_{CE} = 20\text{ V}$, $I_C = 30\text{ A}$	-	36	-	S
Transfer characteristics	V_{GE}	$V_{CE} = 20\text{ V}$, $I_C = 30\text{ A}$	-	7.1	-	V
Zero gate voltage collector current	I_{CES}	$V_{GE} = 0\text{ V}$, $V_{CE} = 1200\text{ V}$	-	0.001	0.23	mA
		$V_{GE} = 0\text{ V}$, $V_{CE} = 1200\text{ V}$, $T_J = 125\text{ °C}$	-	0.5	-	
Gate to emitter leakage current	I_{GES}	$V_{GE} = \pm 30\text{ V}$, $V_{CE} = 0\text{ V}$	-	-	± 200	nA



ELECTRICAL SPECIFICATIONS ($T_J = 25\text{ }^\circ\text{C}$ unless otherwise noted)						
PARAMETER	SYMBOL	TEST CONDITIONS	MIN.	TYP.	MAX.	UNITS
Q2 - Q3 TRENCH IGBT 600 V						
Collector to emitter breakdown voltage	BV_{CES}	$V_{GE} = 0\text{ V}, I_C = 150\text{ }\mu\text{A}$	600	-	-	V
Collector to emitter voltage	$V_{CE(ON)}$	$V_{GE} = 15\text{ V}, I_C = 30\text{ A}$	-	1.42	1.87	
		$V_{GE} = 15\text{ V}, I_C = 30\text{ A}, T_J = 125\text{ }^\circ\text{C}$	-	1.56	-	
Gate threshold voltage	$V_{GE(th)}$	$V_{CE} = V_{GE}, I_C = 1.4\text{ mA}$	3.6	5.6	7.1	
Temperature coefficient of threshold voltage	$\Delta V_{GE(th)}/\Delta T_J$	$V_{CE} = V_{GE}, I_C = 1\text{ mA}$ ($25\text{ }^\circ\text{C}$ to $125\text{ }^\circ\text{C}$)	-	-17	-	mV/°C
Forward transconductance	g_{fe}	$V_{CE} = 20\text{ V}, I_C = 30\text{ A}$	-	24	-	S
Transfer characteristics	V_{GE}	$V_{CE} = 20\text{ V}, I_C = 30\text{ A}$	-	10	-	V
Zero gate voltage collector current	I_{CES}	$V_{GE} = 0\text{ V}, V_{CE} = 600\text{ V}$	-	0.0003	0.23	mA
		$V_{GE} = 0\text{ V}, V_{CE} = 600\text{ V}, T_J = 125\text{ }^\circ\text{C}$	-	0.028	-	
Gate to emitter leakage current	I_{GES}	$V_{GE} = \pm 20\text{ V}, V_{CE} = 0\text{ V}$	-	-	± 200	nA
D1 - D4 ANTIPARALLEL DIODE						
Forward voltage drop	V_{FM}	$I_F = 20\text{ A}$	-	2.42	3.18	V
		$I_F = 20\text{ A}, T_J = 125\text{ }^\circ\text{C}$	-	2.32	-	
D2 - D3 ANTIPARALLEL DIODE						
Forward voltage drop	V_{FM}	$I_F = 20\text{ A}$	-	1.54	1.8	V
		$I_F = 20\text{ A}, T_J = 125\text{ }^\circ\text{C}$	-	1.86	-	

SWITCHING CHARACTERISTICS ($T_J = 25\text{ }^\circ\text{C}$ unless otherwise noted)							
PARAMETER	SYMBOL	TEST CONDITIONS	MIN.	TYP.	MAX.	UNITS	
Q1 - Q4 TRENCH IGBT (WITH FREEWHEELING D1 - D4 ANTIPARALLEL DIODE)							
Total gate charge (turn-on)	Q_g	$I_C = 30\text{ A}$ $V_{CC} = 600\text{ V}$ $V_{GE} = 15\text{ V}$	-	157	-	nC	
Gate to emitter charge (turn-on)	Q_{ge}		-	21	-		
Gate to collector charge (turn-on)	Q_{gc}		-	69	-		
Turn-on switching loss	E_{ON}	$I_C = 30\text{ A}$ $V_{CC} = 600\text{ V}$ $V_{GE} = 15\text{ V}$ $R_g = 4.7\text{ }\Omega$ $L = 500\text{ }\mu\text{H}$ ⁽¹⁾	-	0.52	-	mJ	
Turn-off switching loss	E_{OFF}		-	0.9	-		
Total switching loss	E_{TOT}		-	1.42	-		
Turn-on delay time	$t_{d(on)}$		$R_g = 4.7\text{ }\Omega$ $L = 500\text{ }\mu\text{H}$ ⁽¹⁾	-	93	-	ns
Rise time	t_r			-	39	-	
Turn-off delay time	$t_{d(off)}$			-	133	-	
Fall time	t_f	-		156	-		
Turn-on switching loss	E_{ON}	-		0.64	-		
Turn-off switching loss	E_{OFF}	$I_C = 30\text{ A}$ $V_{CC} = 600\text{ V}$ $V_{GE} = 15\text{ V}$ $R_g = 4.7\text{ }\Omega$ $L = 500\text{ }\mu\text{H}$ $T_J = 125\text{ }^\circ\text{C}$ ⁽¹⁾	-	1.61	-	mJ	
Total switching loss	E_{TOT}		-	2.24	-		
Turn-on delay time	$t_{d(on)}$		-	93	-		
Rise time	t_r		$T_J = 125\text{ }^\circ\text{C}$ ⁽¹⁾	-	39	-	ns
Turn-off delay time	$t_{d(off)}$			-	136	-	
Fall time	t_f			-	193	-	
Input capacitance	C_{ies}	$V_{GE} = 0\text{ V}$ $V_{CC} = 30\text{ V}$ $f = 1\text{ MHz}$	-	3338	-	pF	
Output capacitance	C_{oes}		-	124	-		
Reverse transfer capacitance	C_{res}		-	75	-		
Reverse bias safe operating area	RBSOA	$T_J = 150\text{ }^\circ\text{C}, I_C = 120\text{ A}, V_{CC} = 600\text{ V}, V_P = 1200\text{ V}, R_g = 4.7\text{ }\Omega, V_{GE} = 15\text{ V to } 0\text{ V}$	Fullsquare				



SWITCHING CHARACTERISTICS ($T_J = 25\text{ }^\circ\text{C}$ unless otherwise noted)						
PARAMETER	SYMBOL	TEST CONDITIONS	MIN.	TYP.	MAX.	UNITS
Q2 - Q3 TRENCH IGBT (WITH FREEWHEELING EXTERNAL TO-247 DIODE DISCRETE 30ETH06)						
Total gate charge (turn-on)	Q_g	$I_C = 48\text{ A}$ $V_{CC} = 400\text{ V}$ $V_{GE} = 15\text{ V}$	-	95	-	nC
Gate to emitter charge (turn-on)	Q_{ge}		-	28	-	
Gate to collector charge (turn-on)	Q_{gc}		-	35	-	
Turn-on switching loss	E_{ON}	$I_C = 30\text{ A}$ $V_{CC} = 300\text{ V}$ $V_{GE} = 15\text{ V}$ $R_g = 4.7\text{ }\Omega$ $L = 500\text{ }\mu\text{H}^{(1)}$	-	0.23	-	mJ
Turn-off switching loss	E_{OFF}		-	0.26	-	
Total switching loss	E_{TOT}		-	0.49	-	
Turn-on delay time	$t_{d(on)}$		-	70	-	ns
Rise time	t_r		-	31	-	
Turn-off delay time	$t_{d(off)}$	-	91	-		
Fall time	t_f	-	87	-		
Turn-on switching loss	E_{ON}	$I_C = 30\text{ A}$ $V_{CC} = 300\text{ V}$ $V_{GE} = 15\text{ V}$ $R_g = 4.7\text{ }\Omega$ $L = 500\text{ }\mu\text{H}$ $T_J = 125\text{ }^\circ\text{C}^{(1)}$	-	0.33	-	mJ
Turn-off switching loss	E_{OFF}		-	0.48	-	
Total switching loss	E_{TOT}		-	0.61	-	
Turn-on delay time	$t_{d(on)}$		-	70	-	ns
Rise time	t_r		-	31	-	
Turn-off delay time	$t_{d(off)}$		-	96	-	
Fall time	t_f		-	117	-	
Input capacitance	C_{ies}	$V_{GE} = 0\text{ V}$	-	3025	-	pF
Output capacitance	C_{oes}	$V_{CC} = 30\text{ V}$	-	245	-	
Reverse transfer capacitance	C_{res}	$f = 1\text{ MHz}$	-	90	-	
Reverse bias safe operating area	RBSOA	$T_J = 150\text{ }^\circ\text{C}$, $I_C = 130\text{ A}$ $V_{CC} = 300\text{ V}$, $V_P = 600\text{ V}$ $R_g = 4.7\text{ }\Omega$, $V_{GE} = 15\text{ V to }0\text{ V}$	Fullsquare			
D1 - D4 ANTIPARALLEL DIODE						
Diode reverse recovery time	t_{rr}	$V_R = 400\text{ V}$ $I_F = 20\text{ A}$ $di/dt = 500\text{ A}/\mu\text{s}$	-	103	-	ns
Diode peak reverse current	I_{rr}		-	16	-	A
Diode recovery charge	Q_{rr}		-	800	-	nC
Diode reverse recovery time	t_{rr}	$V_R = 400\text{ V}$ $I_F = 20\text{ A}$ $di/dt = 500\text{ A}/\mu\text{s}$, $T_J = 125\text{ }^\circ\text{C}$	-	135	-	ns
Diode peak reverse current	I_{rr}		-	21	-	A
Diode recovery charge	Q_{rr}		-	1412	-	nC
D2 - D3 ANTIPARALLEL DIODE						
Diode reverse recovery time	t_{rr}	$V_R = 200\text{ V}$ $I_F = 20\text{ A}$ $di/dt = 500\text{ A}/\mu\text{s}$	-	30	-	ns
Diode peak reverse current	I_{rr}		-	4.8	-	A
Diode recovery charge	Q_{rr}		-	73	-	nC
Diode reverse recovery time	t_{rr}	$V_R = 200\text{ V}$ $I_F = 20\text{ A}$ $di/dt = 500\text{ A}/\mu\text{s}$, $T_J = 125\text{ }^\circ\text{C}$	-	31	-	ns
Diode peak reverse current	I_{rr}		-	5	-	A
Diode recovery charge	Q_{rr}		-	78	-	nC

Note

(1) Energy losses include "tail" and diode reverse recovery.

INTERNAL NTC - THERMISTOR SPECIFICATIONS				
PARAMETER	SYMBOL	TEST CONDITIONS	VALUE	UNITS
Resistance	R_{25}	$T_C = 25\text{ }^\circ\text{C}$	5000	Ω
	R_{100}	$T_C = 100\text{ }^\circ\text{C}$	$493 \pm 5\%$	
B-value	$B_{25/50}$	$R_2 = R_{25} \exp. [B_{25/50} (1/T_2 - 1/(298.15\text{ K}))]$	$3375 \pm 5\%$	K
Maximum operating temperature			220	$^\circ\text{C}$
Dissipation constant			2	mW/ $^\circ\text{C}$
Thermal time constant			8	s

THERMAL AND MECHANICAL SPECIFICATIONS					
PARAMETER	SYMBOL	MIN.	TYP.	MAX.	UNITS
Q1 - Q4 TRENCH IGBT 1200 V - Junction to case thermal resistance (per switch)	R_{thJC}	-	-	0.58	$^\circ\text{C/W}$
Q2 - Q3 TRENCH IGBT 600 V- Junction to case thermal resistance (per switch)		-	-	0.72	
D1 - D4 AP diode - Junction to case thermal resistance (per diode)		-	-	0.67	
D2 - D3 AP diode - Junction to case thermal resistance (per diode)		-	-	0.89	
Q1 - Q4 TRENCH IGBT 1200 V - Case to sink thermal resistance (per switch)	$R_{thCS}^{(1)}$	-	0.75	-	
Q2 - Q3 TRENCH IGBT 600 V - Case to sink thermal resistance (per switch)		-	0.77	-	
D1 - D4 AP diode - Case to sink thermal resistance (per diode)		-	0.78	-	
D2 - D3 AP diode - Case to sink thermal resistance (per diode)		-	0.65	-	
Case to sink thermal resistance (per module)		-	0.1	-	
Mounting torque (M4)		2	-	3	
Weight		-	28	-	g

Note

(1) Mounting surface flat, smooth, and greased

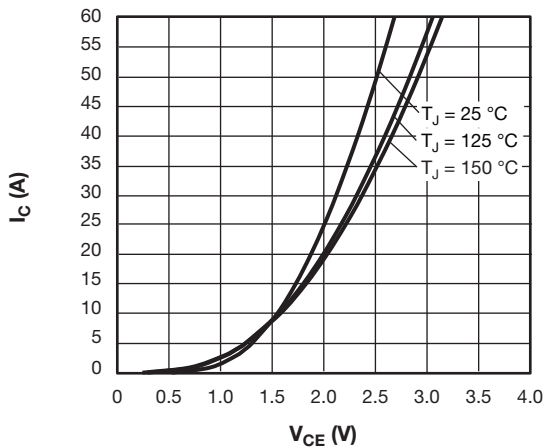
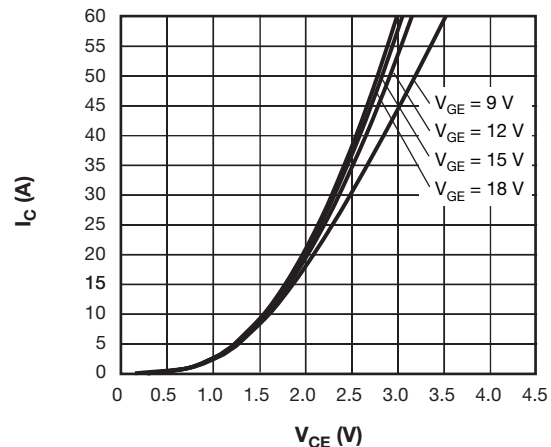
 Fig. 1 - Typical Q1 - Q4 Trench IGBT 1200 V Output Characteristics $V_{GE} = 15\text{ V}$

 Fig. 2 - Typical Q1 - Q4 Trench IGBT 1200 V Output Characteristics $T_J = 125\text{ }^\circ\text{C}$

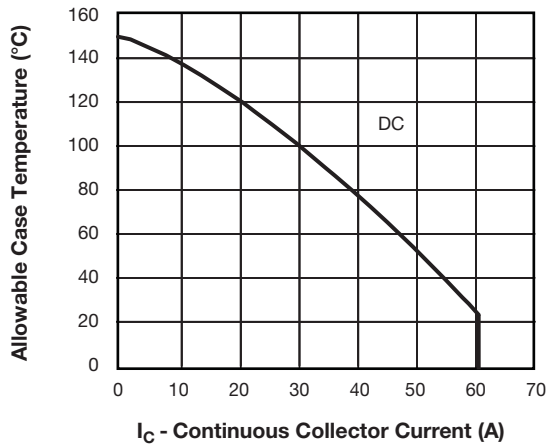

Fig. 3 - Maximum Q1 - Q4 Trench IGBT 1200 V Continuous Collector Current vs. Case Temperature

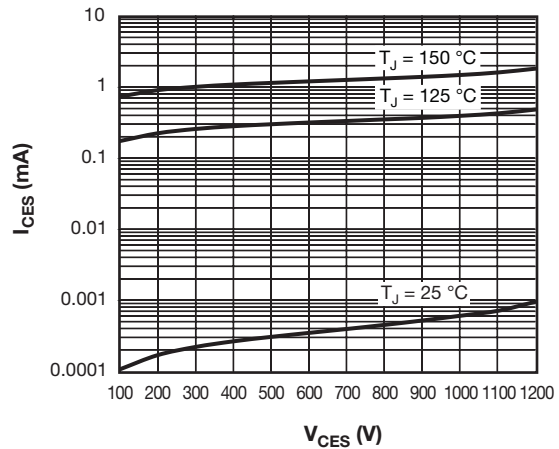

Fig. 6 - Typical Q1 - Q4 Trench IGBT 1200 V Zero Gate Voltage Collector Current

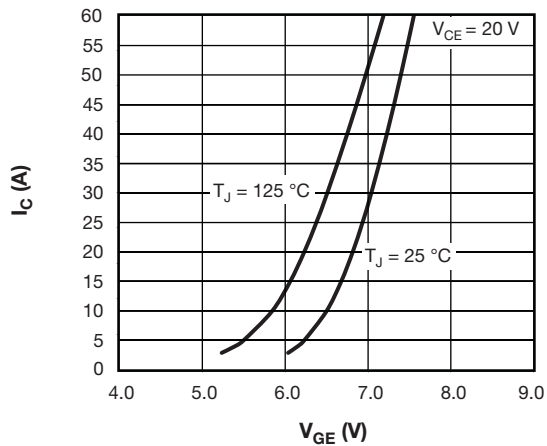

Fig. 4 - Typical Q1 - Q4 Trench IGBT 1200 V Transfer Characteristics

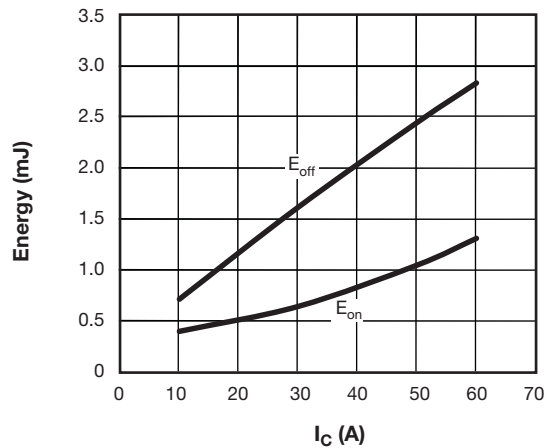

Fig. 7 - Typical Q1 - Q4 Trench IGBT 1200 V Energy Loss vs. I_C (with D1 - D4 Freewheeling Diode), $T_J = 125\text{ }^\circ\text{C}$, $V_{CC} = 600\text{ V}$, $R_g = 4.7\ \Omega$, $V_{GE} = 15\text{ V}$, $L = 500\ \mu\text{H}$

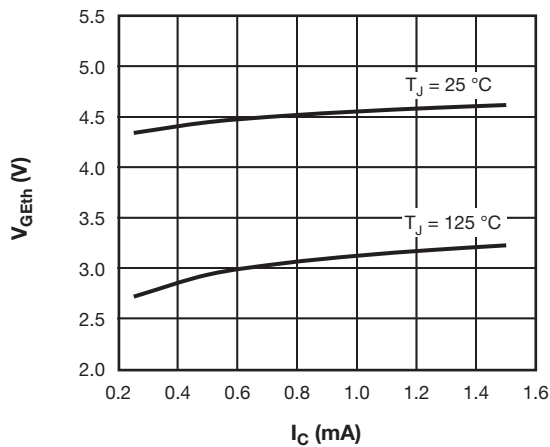

Fig. 5 - Typical Q1 - Q4 Trench IGBT 1200 V Gate Threshold Voltage

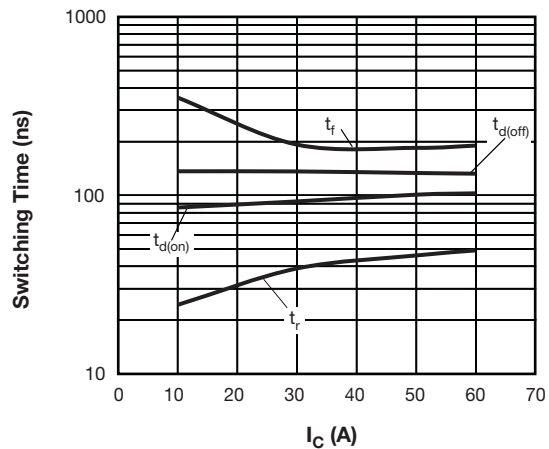

Fig. 8 - Typical Q1 - Q4 Trench IGBT 1200 V Switching Time vs. I_C (with D1 - D4 Freewheeling Diode), $T_J = 125\text{ }^\circ\text{C}$, $V_{CC} = 600\text{ V}$, $R_g = 4.7\ \Omega$, $V_{GE} = 15\text{ V}$, $L = 500\ \mu\text{H}$

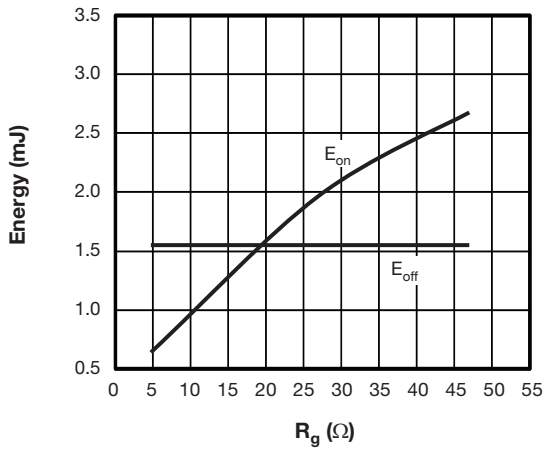

Fig. 9 - Typical Q1 - Q4 Trench IGBT 1200 V Energy Loss vs. R_g (with D1 - D4 Freewheeling Diode)
 $T_J = 125^\circ\text{C}$, $V_{CC} = 600\text{ V}$, $I_C = 30\text{ A}$, $V_{GE} = 15\text{ V}$, $L = 500\ \mu\text{H}$

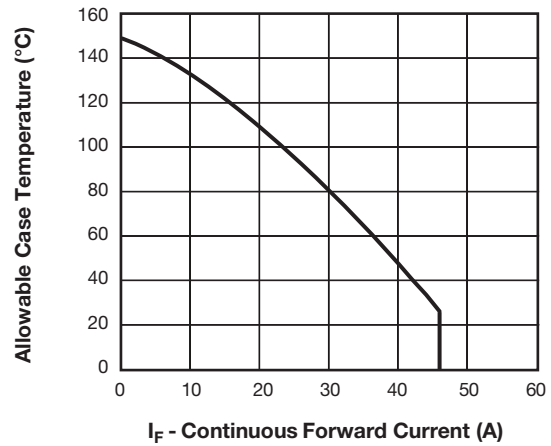

Fig. 12 - Maximum D1 - D4 Antiparallel Diode Forward Current vs. Case Temperature

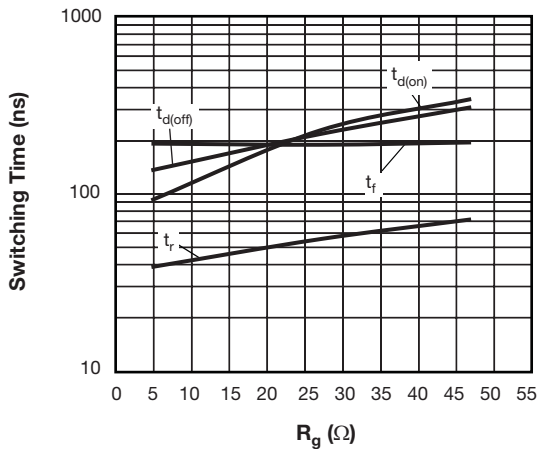

Fig. 10 - Typical Q1 - Q4 Trench IGBT 1200 V Switching Time vs. R_g (with D1 - D4 Freewheeling Diode)
 $T_J = 125^\circ\text{C}$, $V_{CC} = 600\text{ V}$, $I_C = 30\text{ A}$, $V_{GE} = 15\text{ V}$, $L = 500\ \mu\text{H}$

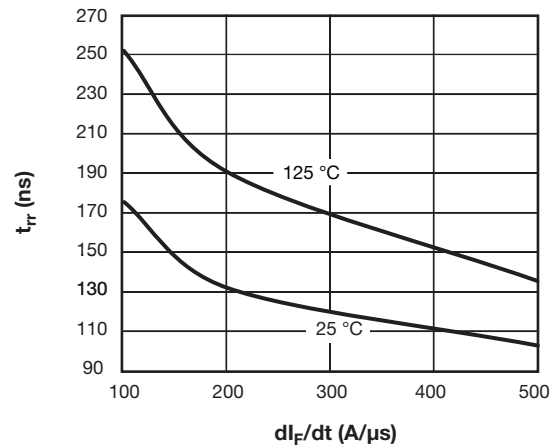

Fig. 13 - Typical D1 - D4 Antiparallel Diode Reverse Recovery Time vs. di_F/dt
 $V_{rr} = 400\text{ V}$, $I_F = 20\text{ A}$

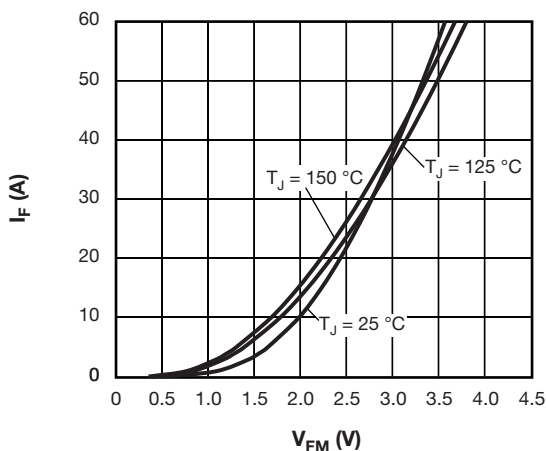

Fig. 11 - Typical D1 - D4 Antiparallel Diode Forward Characteristics

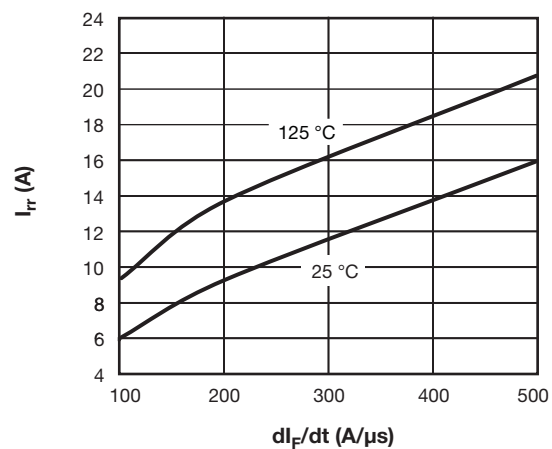

Fig. 14 - Typical D1 - D4 Antiparallel Diode Reverse Recovery Current vs. di_F/dt
 $V_{rr} = 400\text{ V}$, $I_F = 20\text{ A}$

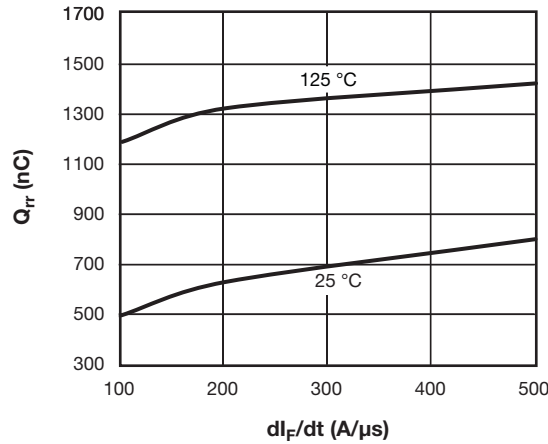

Fig. 15 - Typical D1 - D4 Antiparallel Diode Reverse Recovery Charge vs. di_F/dt
 $V_{rr} = 400$ V, $I_F = 20$ A

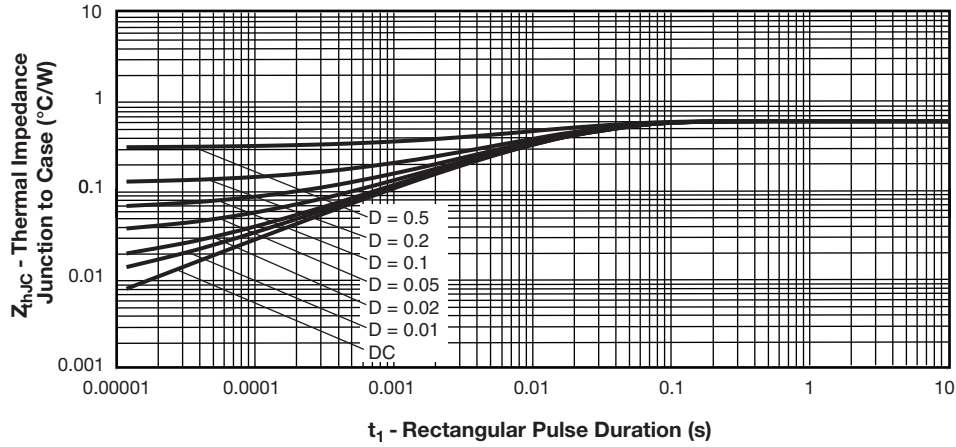

Fig. 16 - Maximum Thermal Impedance Z_{thJC} Characteristics (Q1 - Q4 Trench IGBT 1200 V)

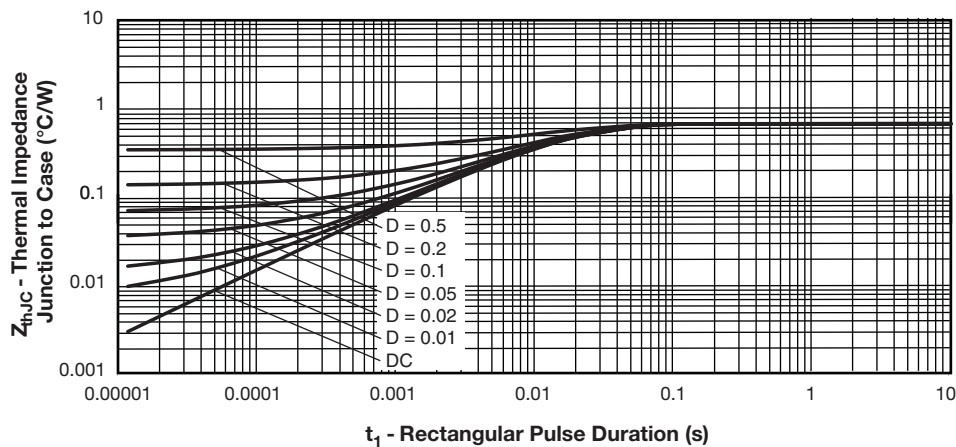

Fig. 17 - Maximum Thermal Impedance Z_{thJC} Characteristics (D1 - D4 Antiparallel Diode)

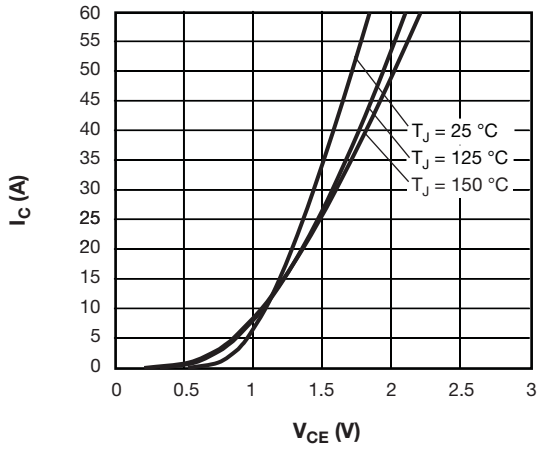

Fig. 18 - Typical Q2 - Q3 Trench IGBT 600 V Output Characteristics
 $V_{GE} = 15\text{ V}$

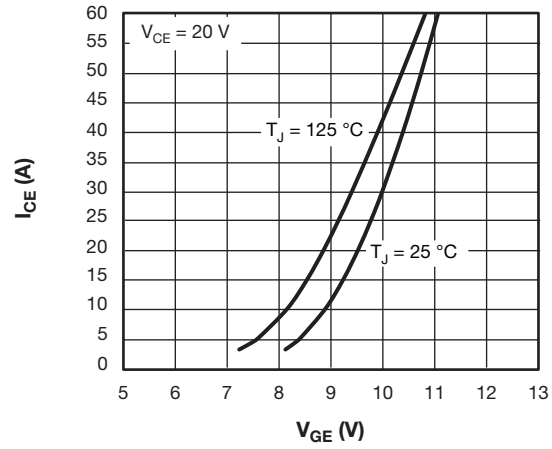

Fig. 21 - Typical Q2 - Q3 Trench IGBT 600 V Transfer Characteristics

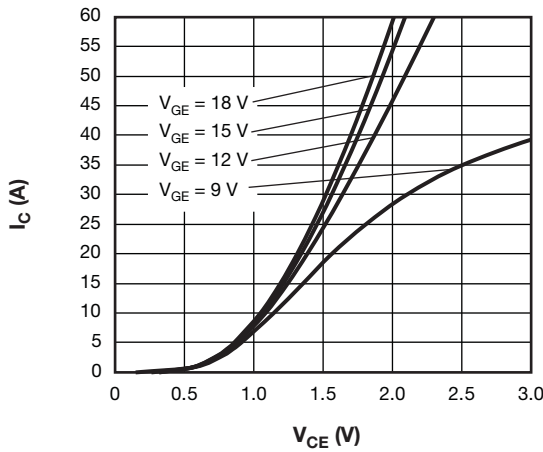

Fig. 19 - Typical Q2 - Q3 Trench IGBT 600 V Output Characteristics
 $T_J = 125\text{ °C}$

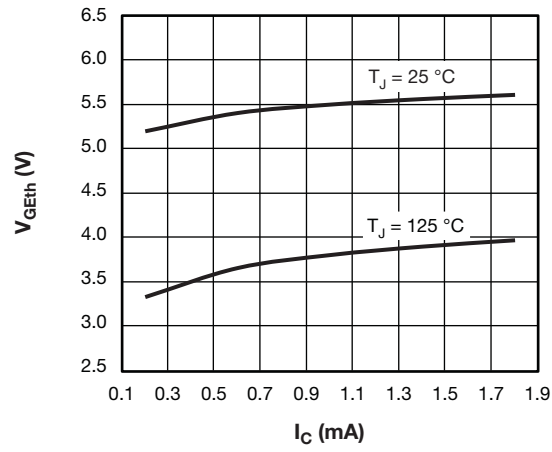

Fig. 22 - Typical Q2 - Q3 Trench IGBT 600 V Gate Threshold Voltage

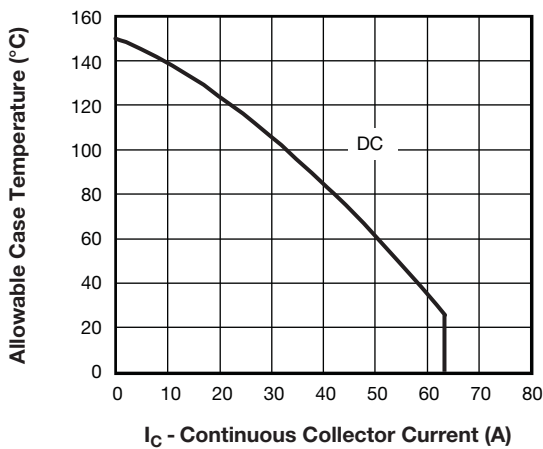

Fig. 20 - Maximum Q2 - Q3 Trench IGBT 600 V Continuous Collector Current vs. Case Temperature

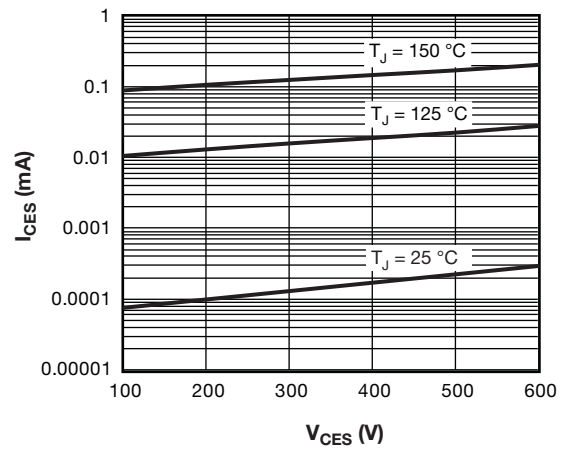

Fig. 23 - Typical Q2 - Q3 Trench IGBT 600 V Zero Gate Voltage Collector Current

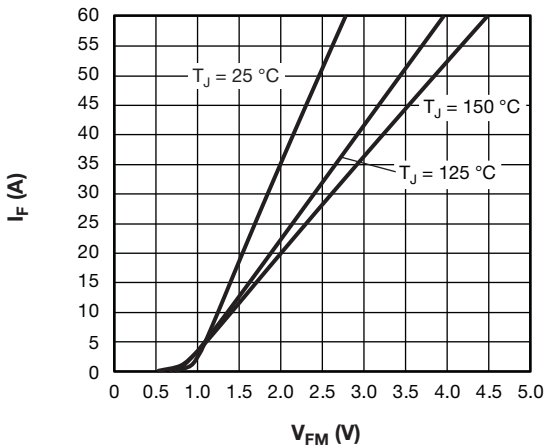

Fig. 24 - Typical D2 - D3 Antiparallel Diode Forward Characteristics

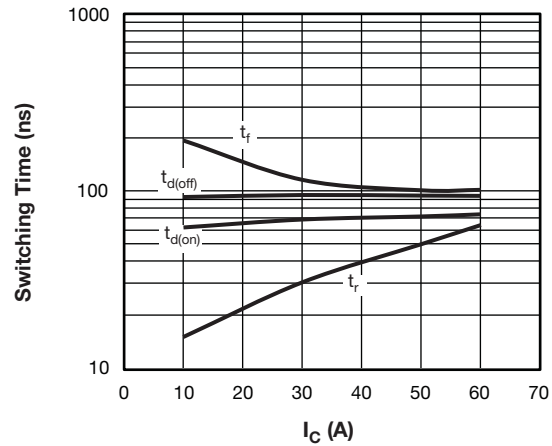

Fig. 27 - Typical Q2 - Q3 Trench IGBT 600 V Switching Time vs. I_C (with Freewheeling External TO-247 Diode Discrete 30ETH06) $T_J = 125\text{ }^\circ\text{C}$, $V_{CC} = 300\text{ V}$, $R_g = 4.7\text{ }\Omega$, $V_{GE} = 15\text{ V}$, $L = 500\text{ }\mu\text{H}$

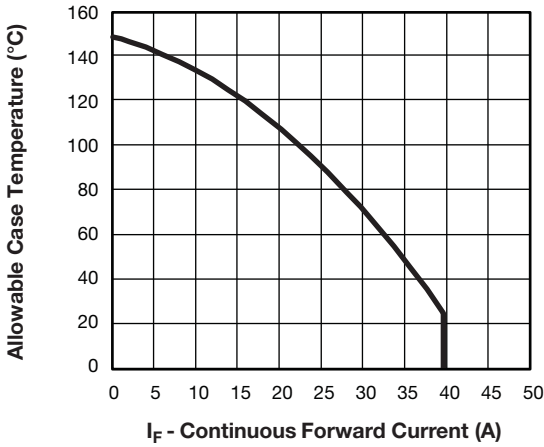

Fig. 25 - Maximum D2 - D3 Antiparallel Diode Forward Current vs. Case Temperature

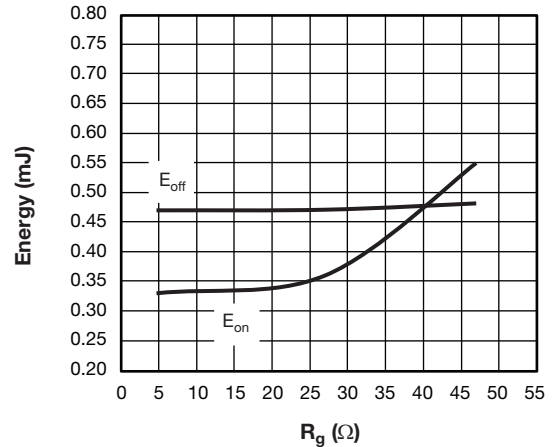

Fig. 28 - Typical Q2 - Q3 Trench IGBT 600 V Energy Loss vs. R_g (with Freewheeling External TO-247 Diode Discrete 30ETH06) $T_J = 125\text{ }^\circ\text{C}$, $V_{CC} = 300\text{ V}$, $I_C = 30\text{ A}$, $V_{GE} = 15\text{ V}$, $L = 500\text{ }\mu\text{H}$

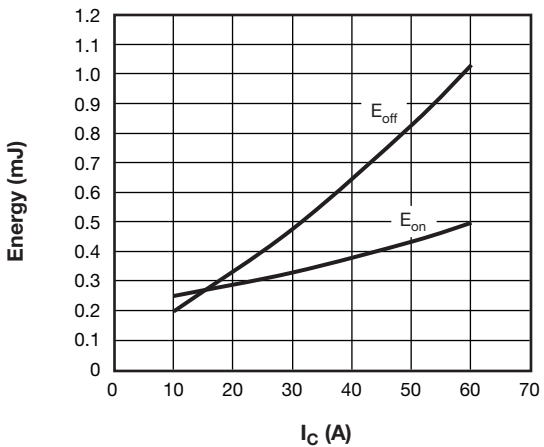

Fig. 26 - Typical Q2 - Q3 Trench IGBT 600 V Energy Loss vs. I_C (with Freewheeling External TO-247 Diode Discrete 30ETH06) $T_J = 125\text{ }^\circ\text{C}$, $V_{CC} = 300\text{ V}$, $R_g = 4.7\text{ }\Omega$, $V_{GE} = 15\text{ V}$, $L = 500\text{ }\mu\text{H}$

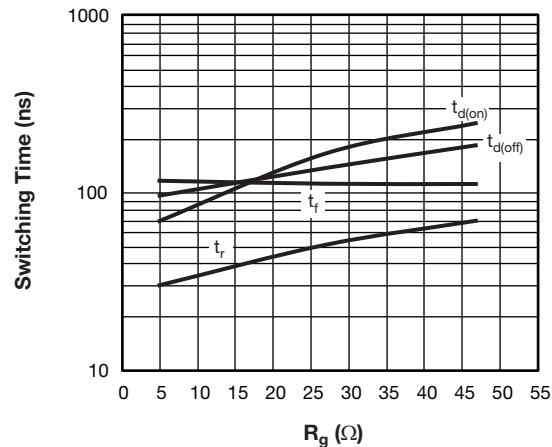

Fig. 29 - Typical Q2 - Q3 Trench IGBT 600 V Switching Time vs. R_g (with Freewheeling External TO-247 Diode Discrete 30ETH06) $T_J = 125\text{ }^\circ\text{C}$, $V_{CC} = 300\text{ V}$, $I_C = 30\text{ A}$, $V_{GE} = 15\text{ V}$, $L = 500\text{ }\mu\text{H}$

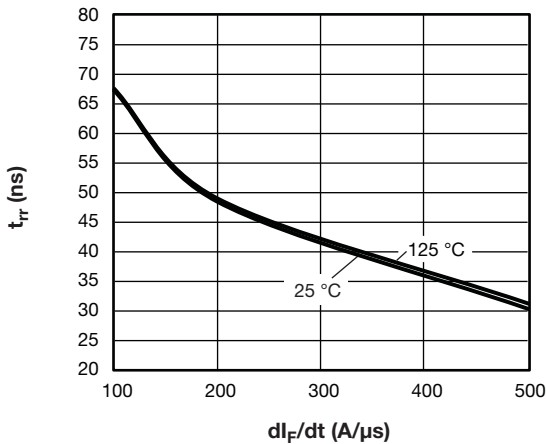

Fig. 30 - Typical D2 - D3 Antiparallel Diode Reverse Recovery Time vs. di_F/dt
 $V_{rr} = 200$ V, $I_F = 20$ A

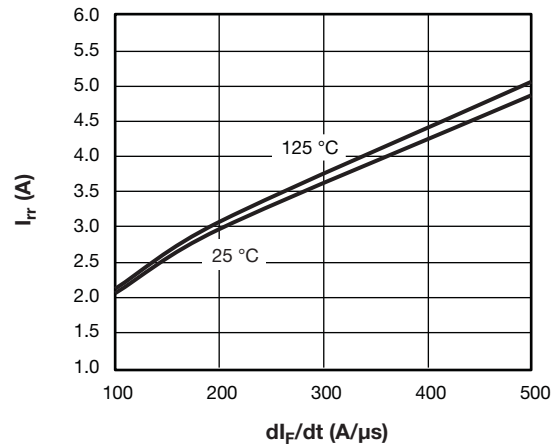

Fig. 31 - Typical D2 - D3 Antiparallel Diode Reverse Recovery Current vs. di_F/dt
 $V_{rr} = 200$ V, $I_F = 20$ A

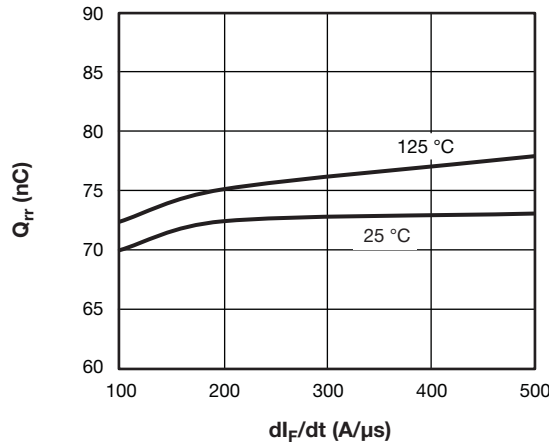

Fig. 32 - Typical D2 - D3 Antiparallel Diode Reverse Recovery Charge vs. di_F/dt
 $V_{rr} = 200$ V, $I_F = 20$ A

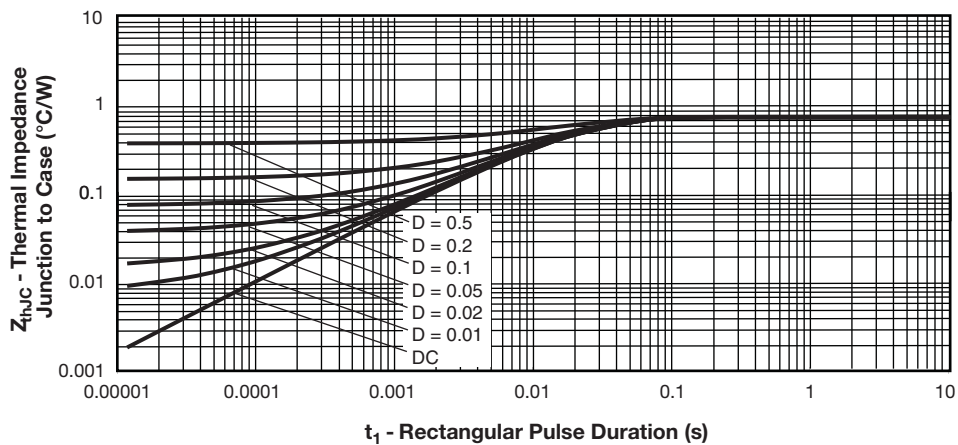

Fig. 33 - Maximum Thermal Impedance Z_{thJC} Characteristics (Q2 - Q3 Trench IGBT 600 V)

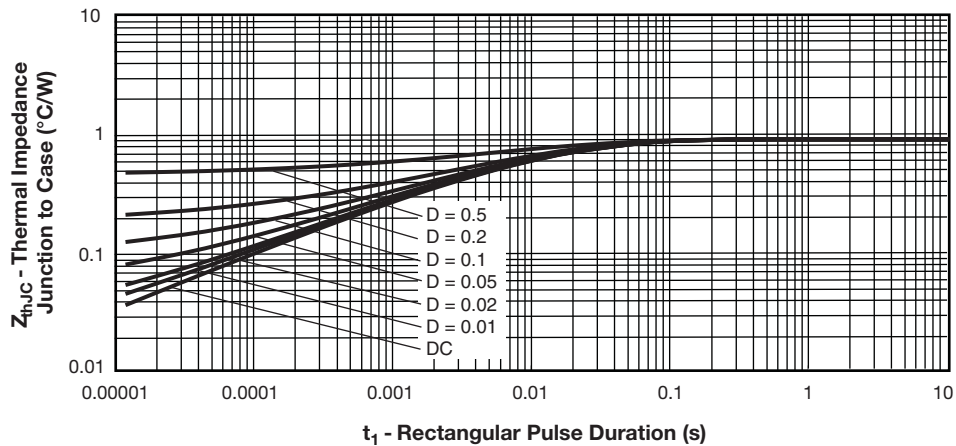
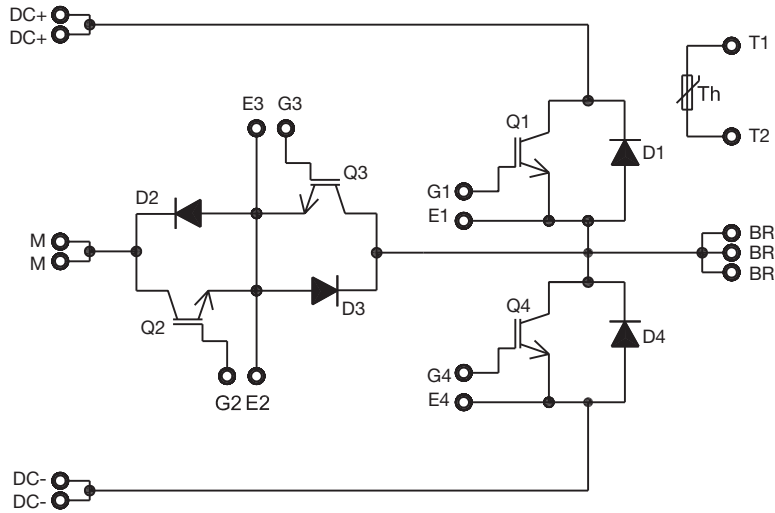
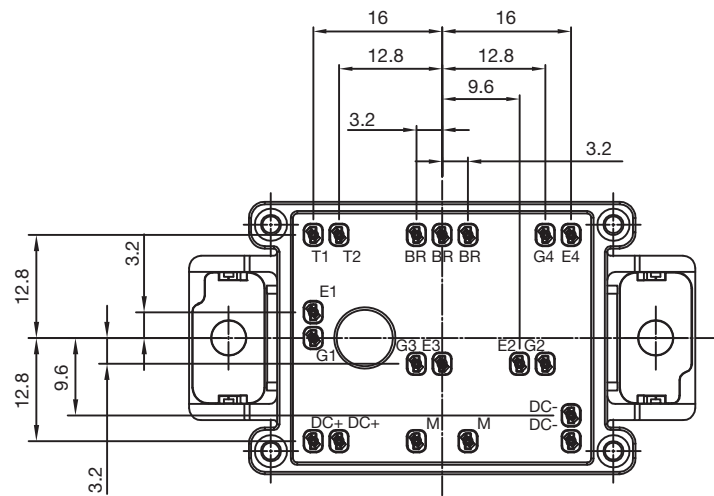

Fig. 34 - Maximum Thermal Impedance Z_{thJC} Characteristics (D2 - D3 Antiparallel Diode)

ORDERING INFORMATION TABLE

Device code	VS-	EN	Q	030	L	120	S
	①	②	③	④	⑤	⑥	⑦

- 1** - Vishay Semiconductors product
- 2** - Package indicator (EN = EMIPAK-1B)
- 3** - Circuit configuration (Q = neutral point clamp topology)
- 4** - Current rating (030 = 30 A)
- 5** - Switch die technology (L = ultrafast Trench IGBT 1200 V and Trench IGBT 600 V)
- 6** - Voltage rating (120 = 1200 V)
- 7** - Diode die technology (S = SiC diode)

CIRCUIT CONFIGURATION

PACKAGE

LINKS TO RELATED DOCUMENTS

Dimensions

www.vishay.com/doc?95558



EMIPAK-1B PressFit

DIMENSIONS in millimeters

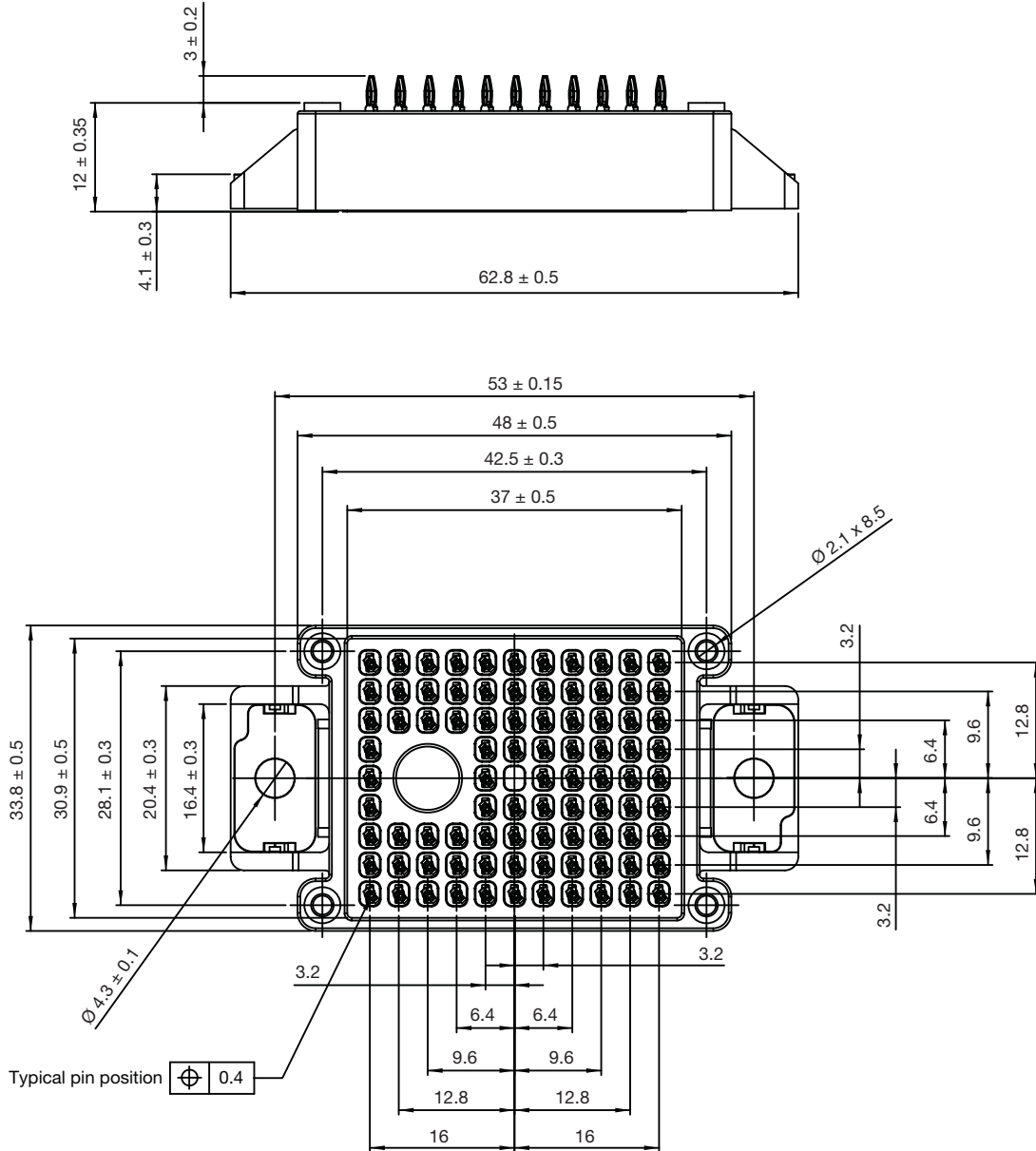



Disclaimer

ALL PRODUCT, PRODUCT SPECIFICATIONS AND DATA ARE SUBJECT TO CHANGE WITHOUT NOTICE TO IMPROVE RELIABILITY, FUNCTION OR DESIGN OR OTHERWISE.

Vishay Intertechnology, Inc., its affiliates, agents, and employees, and all persons acting on its or their behalf (collectively, "Vishay"), disclaim any and all liability for any errors, inaccuracies or incompleteness contained in any datasheet or in any other disclosure relating to any product.

Vishay makes no warranty, representation or guarantee regarding the suitability of the products for any particular purpose or the continuing production of any product. To the maximum extent permitted by applicable law, Vishay disclaims (i) any and all liability arising out of the application or use of any product, (ii) any and all liability, including without limitation special, consequential or incidental damages, and (iii) any and all implied warranties, including warranties of fitness for particular purpose, non-infringement and merchantability.

Statements regarding the suitability of products for certain types of applications are based on Vishay's knowledge of typical requirements that are often placed on Vishay products in generic applications. Such statements are not binding statements about the suitability of products for a particular application. It is the customer's responsibility to validate that a particular product with the properties described in the product specification is suitable for use in a particular application. Parameters provided in datasheets and / or specifications may vary in different applications and performance may vary over time. All operating parameters, including typical parameters, must be validated for each customer application by the customer's technical experts. Product specifications do not expand or otherwise modify Vishay's terms and conditions of purchase, including but not limited to the warranty expressed therein.

Except as expressly indicated in writing, Vishay products are not designed for use in medical, life-saving, or life-sustaining applications or for any other application in which the failure of the Vishay product could result in personal injury or death. Customers using or selling Vishay products not expressly indicated for use in such applications do so at their own risk. Please contact authorized Vishay personnel to obtain written terms and conditions regarding products designed for such applications.

No license, express or implied, by estoppel or otherwise, to any intellectual property rights is granted by this document or by any conduct of Vishay. Product names and markings noted herein may be trademarks of their respective owners.