



Chipsmall Limited consists of a professional team with an average of over 10 year of expertise in the distribution of electronic components. Based in Hongkong, we have already established firm and mutual-benefit business relationships with customers from,Europe,America and south Asia,supplying obsolete and hard-to-find components to meet their specific needs.

With the principle of “Quality Parts,Customers Priority,Honest Operation,and Considerate Service”,our business mainly focus on the distribution of electronic components. Line cards we deal with include Microchip,ALPS,ROHM,Xilinx,Pulse,ON,Everlight and Freescale. Main products comprise IC,Modules,Potentiometer,IC Socket,Relay,Connector.Our parts cover such applications as commercial,industrial, and automotives areas.

We are looking forward to setting up business relationship with you and hope to provide you with the best service and solution. Let us make a better world for our industry!



Contact us

Tel: +86-755-8981 8866 Fax: +86-755-8427 6832

Email & Skype: info@chipsmall.com Web: www.chipsmall.com

Address: A1208, Overseas Decoration Building, #122 Zhenhua RD., Futian, Shenzhen, China



Insulated Gate Bipolar Transistor (Warp 2 Speed IGBT), 100 A



SOT-227

FEATURES

- Ultrafast: Optimized for minimum saturation voltage and speed 0 to 40 kHz in hard switching, > 200 kHz in resonant mode
- Very low conduction and switching losses
- Fully isolated package (2500 V_{AC}/RMS)
- Very low internal inductance (≤ 5 nH typical)
- Industry standard outline
- UL approved file E78996
- Compliant to RoHS Directive 2002/95/EC
- Designed and qualified for industrial market

**RoHS
COMPLIANT**

PRODUCT SUMMARY	
V _{CES}	600 V
I _C DC	100 A
V _{CE(on)} at 100 A, 25 °C	1.8 V

BENEFITS

- Designed for increased operating efficiency in power conversion: PFC, UPS, SMPS, welding, induction heating
- Lower overall losses available at frequencies ≥ 20 kHz
- Easy to assemble and parallel
- Direct mounting to heatsink
- Lower EMI, requires less snubbing
- Plug in compatible with other SOT-227 packages

ABSOLUTE MAXIMUM RATINGS				
PARAMETER	SYMBOL	TEST CONDITIONS	MAX.	UNITS
Collector to emitter breakdown voltage	V _{CES}		600	V
Continuous collector current	I _C	T _C = 25 °C	100	A
		T _C = 100 °C	50	
Pulsed collector current	I _{CM}		200	
Clamped inductive load current	I _{LM}	Repetitive rating: V _{GE} = 20 V; pulse width limited by maximum junction temperature (fig. 20)	200	
Gate to emitter voltage	V _{GE}		± 20	V
RMS isolation voltage	V _{ISOL}	Any terminal to case, t = 1 minute	2500	
Maximum power dissipation	P _D	T _C = 25 °C	250	W
		T _C = 100 °C	100	
Operating junction and storage temperature range	T _J , T _{Stg}		- 55 to + 150	°C
Mounting torque		6 to 32 or M3 screw	12 (1.3)	lbf · in (N · m)

THERMAL AND MECHANICAL SPECIFICATIONS				
PARAMETER	SYMBOL	TYP.	MAX.	UNITS
Junction to case, IGBT	R _{thJC}	-	0.50	°C/W
Thermal resistance, junction to case, diode	R _{thJC}	-	1.0	
Case to sink, flat, greased surface	R _{thCS}	0.05	-	
Weight of module		30	-	g



ELECTRICAL SPECIFICATIONS ($T_J = 25\text{ }^\circ\text{C}$ unless otherwise specified)							
PARAMETER	SYMBOL	TEST CONDITIONS		MIN.	TYP.	MAX.	UNITS
Collector to emitter breakdown voltage	$V_{(BR)CES}$	$V_{GE} = 0\text{ V}, I_C = 250\text{ }\mu\text{A}$		600	-	-	V
Temperature coefficient of breakdown voltage	$\Delta V_{(BR)CES}/\Delta T_J$	$V_{GE} = 0\text{ V}, I_C = 1.0\text{ mA}$		-	0.36	-	V/ $^\circ\text{C}$
Collector to emitter saturation voltage	$V_{CE(on)}$	$V_{GE} = 15\text{ V}, I_C = 50\text{ A}$	See fig. 1, 4	-	1.49	2.1	V
		$V_{GE} = 15\text{ V}, I_C = 100\text{ A}$		-	1.80	-	
		$V_{GE} = 15\text{ V}, I_C = 50\text{ A}, T_J = 150\text{ }^\circ\text{C}$		-	1.47	-	
Gate threshold voltage	$V_{GE(th)}$	$V_{CE} = V_{GE}, I_C = 250\text{ }\mu\text{A}$		3.0	-	6.0	
Temperature coefficient of threshold voltage	$\Delta V_{GE(th)}/\Delta T_J$	$V_{CE} = V_{GE}, I_C = 250\text{ }\mu\text{A}$		-	- 7.6	-	mV/ $^\circ\text{C}$
Forward transconductance	g_{fe}	$V_{CE} = 100\text{ V}, I_C = 50\text{ A}$		34	52	-	S
Zero gate voltage collector current	I_{CES}	$V_{GE} = 0\text{ V}, V_{CE} = 600\text{ V}$		-	-	250	μA
		$V_{GE} = 0\text{ V}, V_{CE} = 600\text{ V}, T_J = 150\text{ }^\circ\text{C}$		-	-	1.3	mA
Diode forward voltage drop	V_{FM}	$I_C = 50\text{ A}$	See fig. 12	-	1.3	1.6	V
		$I_C = 50\text{ A}, T_J = 150\text{ }^\circ\text{C}$		-	1.16	1.3	
Gate to emitter leakage current	I_{GES}	$V_{GE} = \pm 20\text{ V}$		-	-	± 100	nA

SWITCHING CHARACTERISTICS ($T_J = 25\text{ }^\circ\text{C}$ unless otherwise specified)								
PARAMETER	SYMBOL	TEST CONDITIONS		MIN.	TYP.	MAX.	UNITS	
Total gate charge (turn-on)	Q_g	$I_C = 50\text{ A}$ $V_{CC} = 400\text{ V}$ $V_{GE} = 15\text{ V}$	See fig. 7	-	430	640	nC	
Gate emitter charge (turn-on)	Q_{ge}			-	48	72		
Gate collector charge (turn-on)	Q_{gc}			-	130	190		
Turn-on delay time	$t_{d(on)}$	$T_J = 25\text{ }^\circ\text{C}$ $I_C = 60\text{ A}, V_{CC} = 480\text{ V}$ $V_{GE} = 15\text{ V}, R_g = 5.0\text{ }\Omega$ energy losses include "tail" and diode reverse recovery		-	57	-	ns	
Rise time	t_r			-	80	-		
Turn-off delay time	$t_{d(off)}$			-	240	-		
Fall time	t_f			-	120	-		
Turn-on switching loss	E_{on}			-	0.41	-		mJ
Turn-off switching loss	E_{off}	-	2.51	-				
Total switching loss	E_{ts}	-	2.92	4.4				
Turn-on delay time	$t_{d(on)}$	$T_J = 150\text{ }^\circ\text{C}$ $I_C = 60\text{ A}, V_{CC} = 480\text{ V}$ $V_{GE} = 15\text{ V}, R_g = 5.0\text{ }\Omega$ energy losses include "tail" and diode reverse recovery		-	57	-	ns	
Rise time	t_r			-	80	-		
Turn-off delay time	$t_{d(off)}$			-	380	-		
Fall time	t_f			-	170	-		
Total switching loss	E_{ts}			-	4.78	-		mJ
Internal emitter inductance	L_E			-	2.0	-	nH	
Input capacitance	C_{ies}	$V_{GE} = 0\text{ V}$ $V_{CC} = 30\text{ V}$ $f = 1.0\text{ MHz}$	See fig. 6	-	7400	-	pF	
Output capacitance	C_{oes}			-	730	-		
Reverse transfer capacitance	C_{res}			-	90	-		
Diode reverse recovery time	t_{rr}	$T_J = 25\text{ }^\circ\text{C}$	See fig. 13	$I_F = 50\text{ A}$ $V_R = 200\text{ V}$ $di/dt = 200\text{ A}/\mu\text{s}$	-	90	140	ns
		$T_J = 125\text{ }^\circ\text{C}$			-	120	180	
Diode peak reverse recovery current	I_{rr}	$T_J = 25\text{ }^\circ\text{C}$	See fig. 14		-	7.3	11	A
		$T_J = 125\text{ }^\circ\text{C}$			-	11	16	
Diode reverse recovery charge	Q_{rr}	$T_J = 25\text{ }^\circ\text{C}$	See fig. 15		-	360	550	nC
		$T_J = 125\text{ }^\circ\text{C}$			-	780	1200	
Diode peak rate of fall recovery during t_b	$dl_{(rec)M}/dt$	$T_J = 25\text{ }^\circ\text{C}$	See fig. 16	-	370	-	A/ μs	
		$T_J = 125\text{ }^\circ\text{C}$		-	220	-		

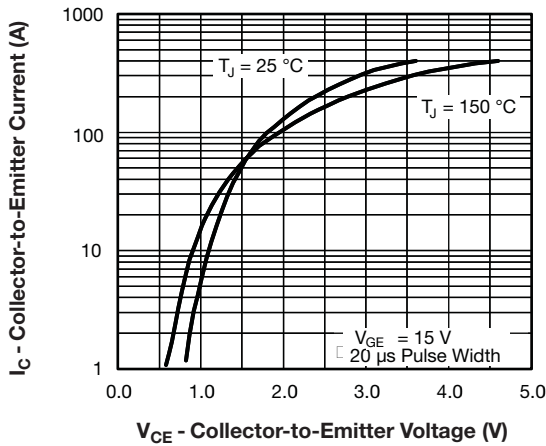

Fig. 1 - Typical Output Characteristics

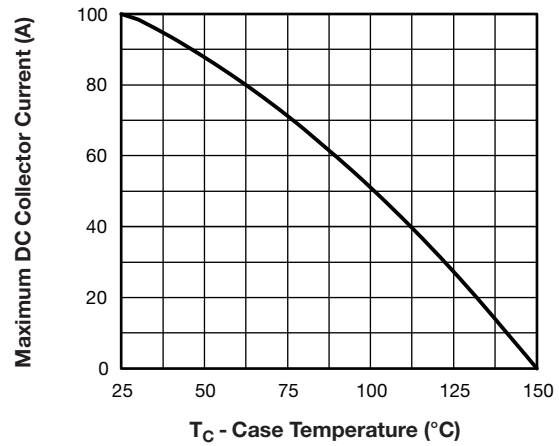

Fig. 3 - Maximum Collector Current vs. Case Temperature

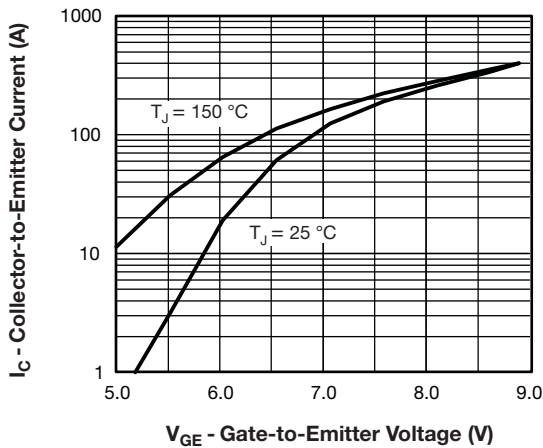

Fig. 2 - Typical Transfer Characteristics

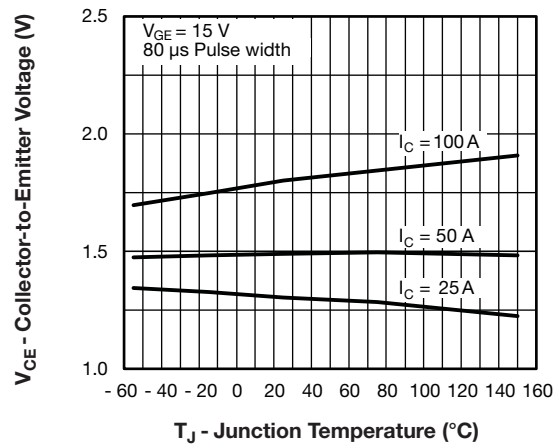

Fig. 4 - Typical Collector to Emitter Voltage vs. Junction Temperature

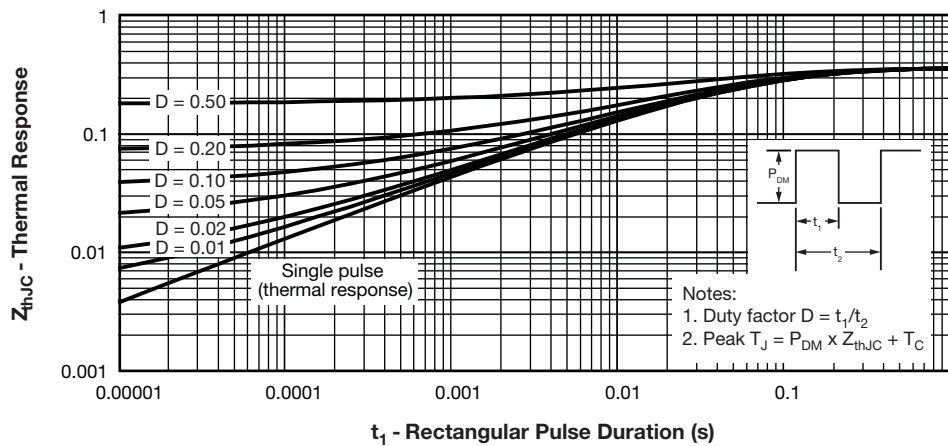

Fig. 5 - Maximum Effective Transient Thermal Impedance, Junction to Case

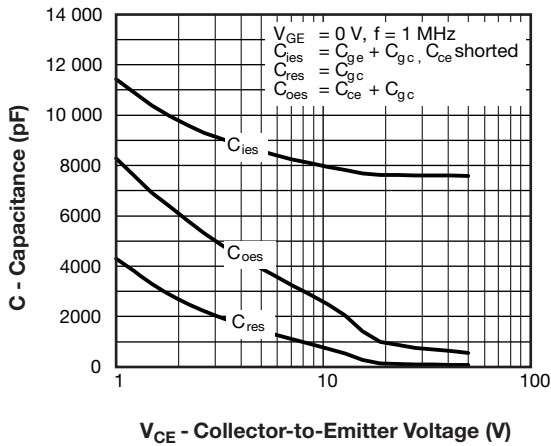

Fig. 6 - Typical Capacitance vs. Collector to Emitter Voltage

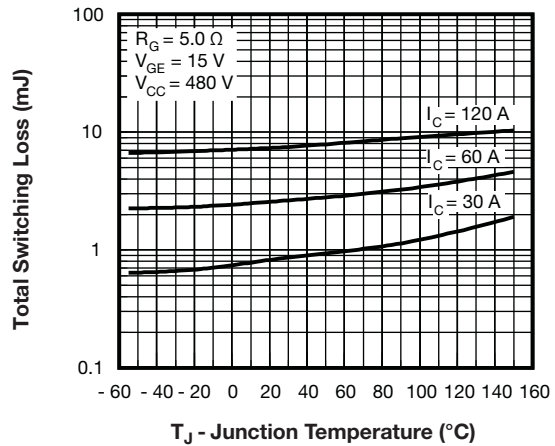

Fig. 9 - Typical Switching Losses vs. Junction Temperature

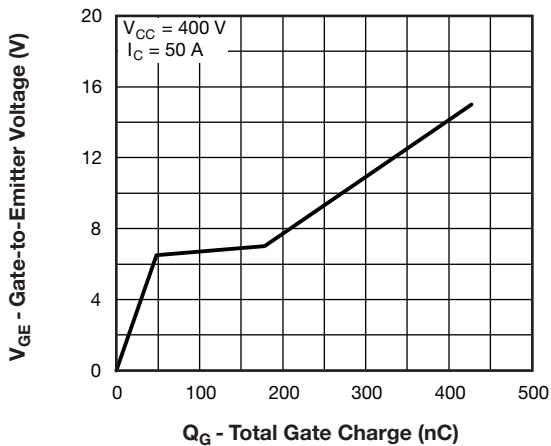

Fig. 7 - Typical Gate Charge vs. Gate to Emitter Voltage

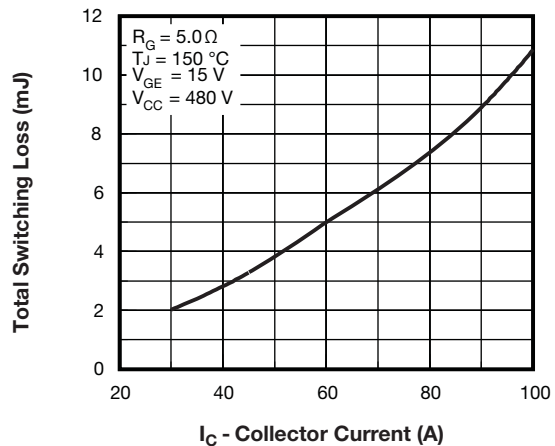

Fig. 10 - Typical Switching Losses vs. Collector to Emitter Current

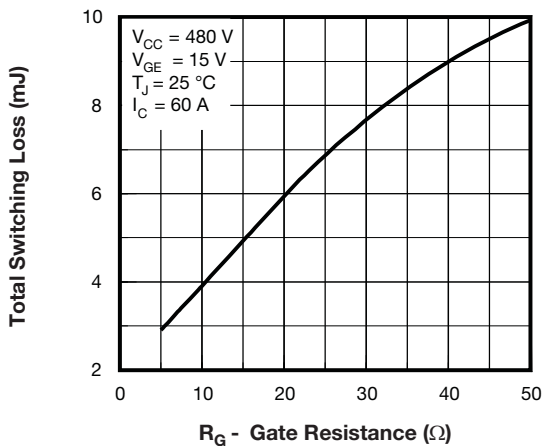

Fig. 8 - Typical Switching Losses vs. Gate Resistance

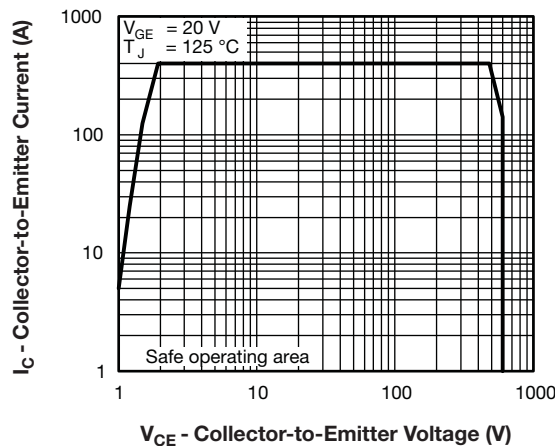

Fig. 11 - Turn-Off SOA

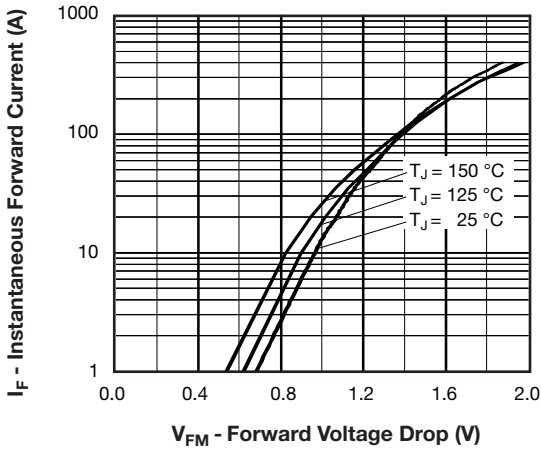

Fig. 12 - Typical Forward Voltage Drop vs. Instantaneous Forward Current

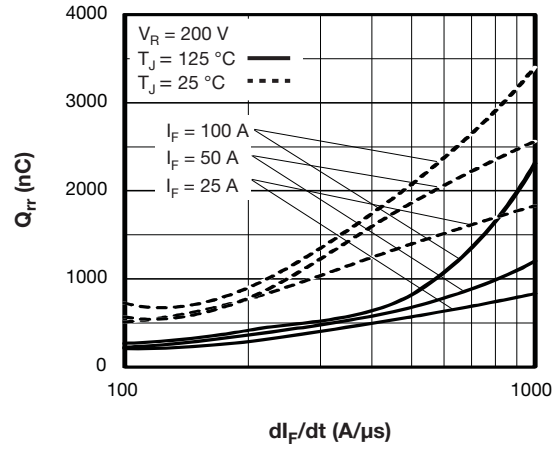

Fig. 15 - Typical Stored Charge vs. dI_F/dt

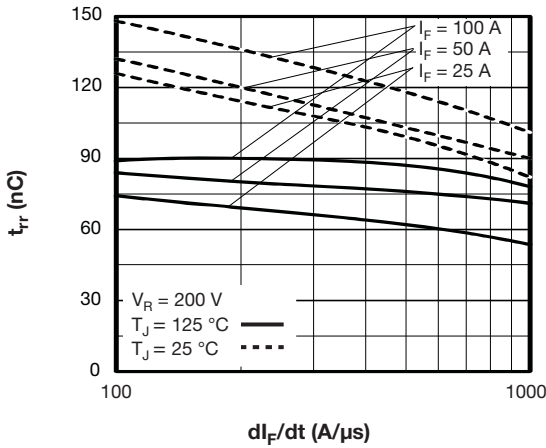

Fig. 13 - Typical Reverse Recovery vs. dI_F/dt

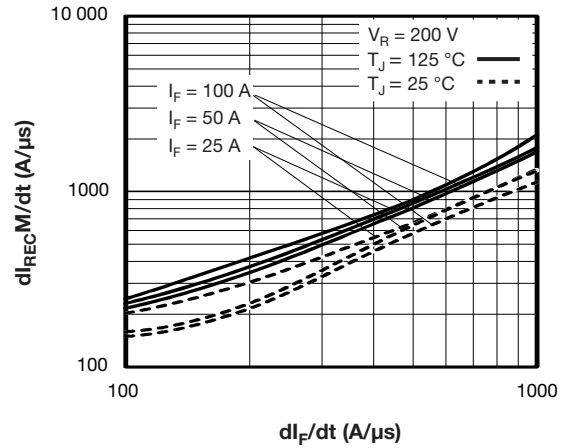

Fig. 16 - Typical $dI_{REC}/M/dt$ vs. dI_F/dt

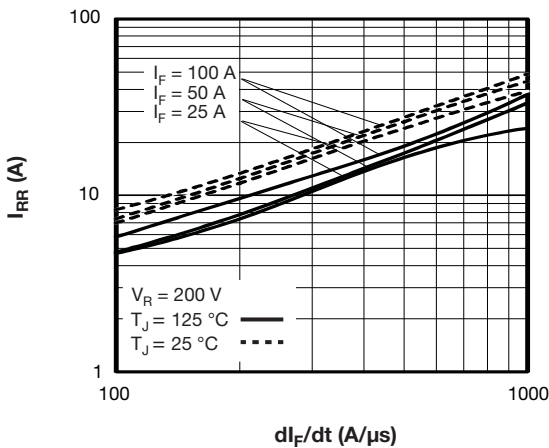

Fig. 14 - Typical Recovery Current vs. dI_F/dt

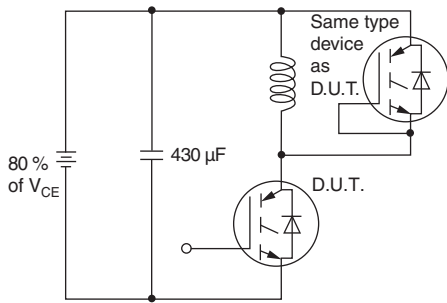

Fig. 17a - Test Circuit for Measurement of I_{LM} , E_{on} , $E_{off}(\text{diode})$, t_{rr} , Q_{rr} , I_{rr} , $t_{d(on)}$, t_r , $t_{d(off)}$, t_f

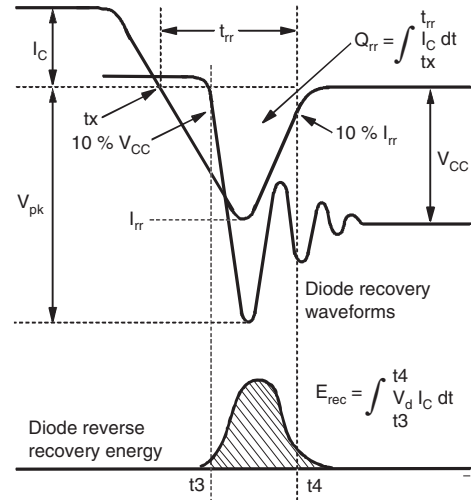

Fig. 1 - Test Waveforms for Circuit of Fig. 17a, Defining E_{rec} , t_{rr} , Q_{rr} , I_{rr}

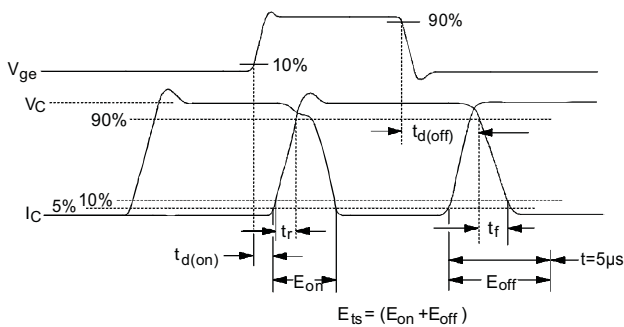

Fig. 17b - Test Waveforms for Circuit of Fig. 17a, Defining E_{off} , $t_{d(off)}$, t_f

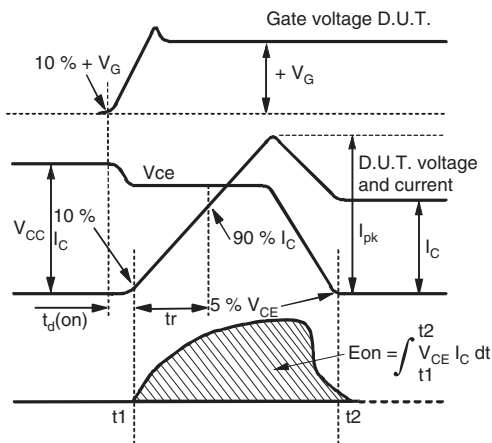

Fig. 17c - Test Waveforms for Circuit of Fig. 17a, Defining E_{on} , $t_{d(on)}$, t_r

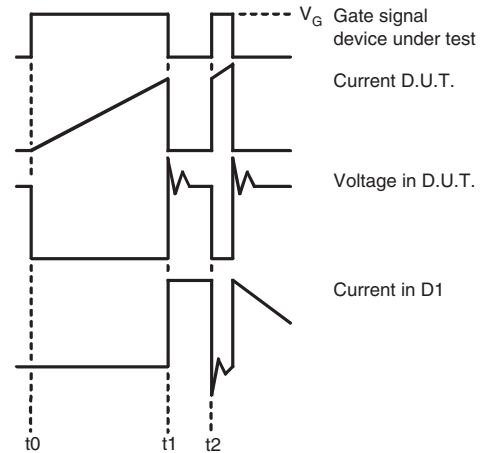

Fig. 17e - Macro Waveforms for Figure 17a's Test Circuit

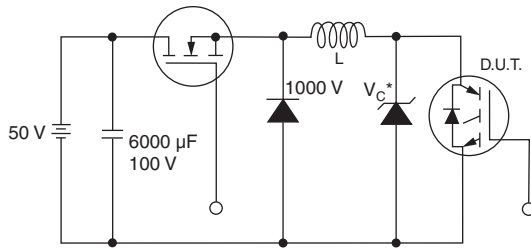

Fig. 18a - Clamped Inductive Load Test Circuit

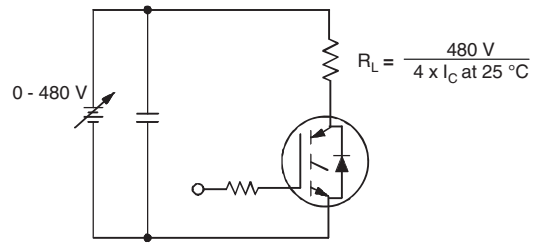

Fig. 18b - Pulsed Collector Current Test Circuit

ORDERING INFORMATION TABLE

Device code	VS-	G	A	100	N	A	60	U	P
	1	2	3	4	5	6	7	8	9

- 1** - Vishay Semiconductors product
- 2** - Device:
G = IGBT
- 3** - Silicon technology:
A = Generation 4 IGBT, Generation 2 HEXFRED®
- 4** - Current rating (100 = 100 A)
- 5** - N = High side chopper
- 6** - SOT-227
- 7** - Voltage rating (60 = 600 V)
- 8** - U = Ultrafast with matching diode
- 9** -
 - None = Standard production
 - P = Lead (Pb)-free

CIRCUIT CONFIGURATION

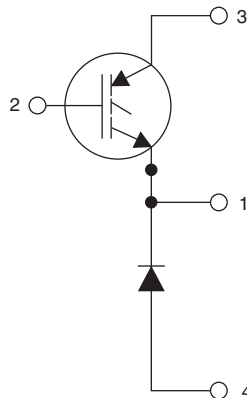

LINKS TO RELATED DOCUMENTS	
Dimensions	www.vishay.com/doc?95036
Packaging information	www.vishay.com/doc?95037

SOT-227

DIMENSIONS in millimeters (inches)

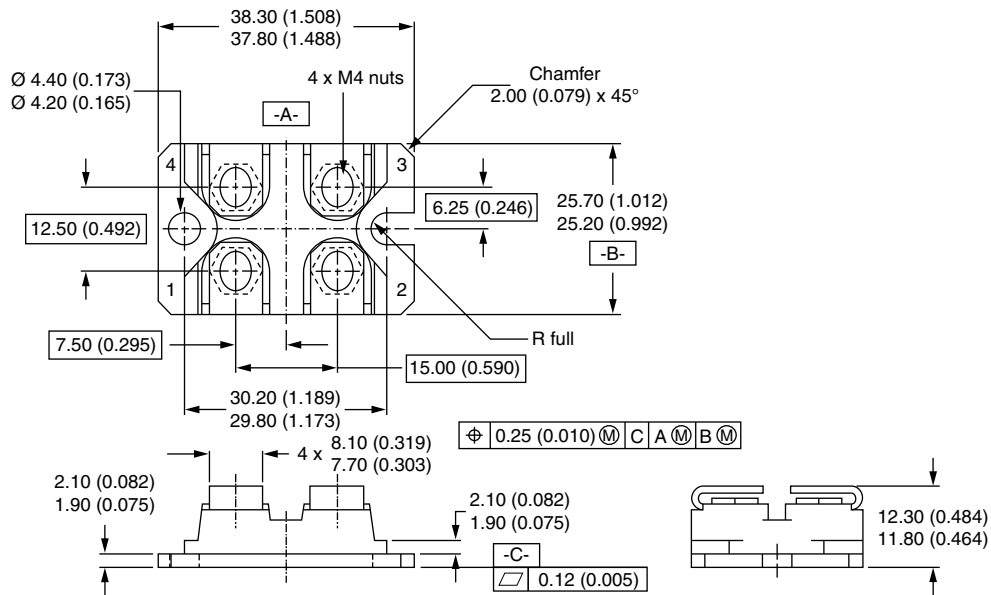

Notes

- Dimensioning and tolerancing per ANSI Y14.5M-1982
- Controlling dimension: millimeter



Disclaimer

ALL PRODUCT, PRODUCT SPECIFICATIONS AND DATA ARE SUBJECT TO CHANGE WITHOUT NOTICE TO IMPROVE RELIABILITY, FUNCTION OR DESIGN OR OTHERWISE.

Vishay Intertechnology, Inc., its affiliates, agents, and employees, and all persons acting on its or their behalf (collectively, "Vishay"), disclaim any and all liability for any errors, inaccuracies or incompleteness contained in any datasheet or in any other disclosure relating to any product.

Vishay makes no warranty, representation or guarantee regarding the suitability of the products for any particular purpose or the continuing production of any product. To the maximum extent permitted by applicable law, Vishay disclaims (i) any and all liability arising out of the application or use of any product, (ii) any and all liability, including without limitation special, consequential or incidental damages, and (iii) any and all implied warranties, including warranties of fitness for particular purpose, non-infringement and merchantability.

Statements regarding the suitability of products for certain types of applications are based on Vishay's knowledge of typical requirements that are often placed on Vishay products in generic applications. Such statements are not binding statements about the suitability of products for a particular application. It is the customer's responsibility to validate that a particular product with the properties described in the product specification is suitable for use in a particular application. Parameters provided in datasheets and/or specifications may vary in different applications and performance may vary over time. All operating parameters, including typical parameters, must be validated for each customer application by the customer's technical experts. Product specifications do not expand or otherwise modify Vishay's terms and conditions of purchase, including but not limited to the warranty expressed therein.

Except as expressly indicated in writing, Vishay products are not designed for use in medical, life-saving, or life-sustaining applications or for any other application in which the failure of the Vishay product could result in personal injury or death. Customers using or selling Vishay products not expressly indicated for use in such applications do so at their own risk. Please contact authorized Vishay personnel to obtain written terms and conditions regarding products designed for such applications.

No license, express or implied, by estoppel or otherwise, to any intellectual property rights is granted by this document or by any conduct of Vishay. Product names and markings noted herein may be trademarks of their respective owners.

Material Category Policy

Vishay Intertechnology, Inc. hereby certifies that all its products that are identified as RoHS-Compliant fulfill the definitions and restrictions defined under Directive 2011/65/EU of The European Parliament and of the Council of June 8, 2011 on the restriction of the use of certain hazardous substances in electrical and electronic equipment (EEE) - recast, unless otherwise specified as non-compliant.

Please note that some Vishay documentation may still make reference to RoHS Directive 2002/95/EC. We confirm that all the products identified as being compliant to Directive 2002/95/EC conform to Directive 2011/65/EU.

Vishay Intertechnology, Inc. hereby certifies that all its products that are identified as Halogen-Free follow Halogen-Free requirements as per JEDEC JS709A standards. Please note that some Vishay documentation may still make reference to the IEC 61249-2-21 definition. We confirm that all the products identified as being compliant to IEC 61249-2-21 conform to JEDEC JS709A standards.