



Chipsmall Limited consists of a professional team with an average of over 10 year of expertise in the distribution of electronic components. Based in Hongkong, we have already established firm and mutual-benefit business relationships with customers from,Europe,America and south Asia,supplying obsolete and hard-to-find components to meet their specific needs.

With the principle of “Quality Parts,Customers Priority,Honest Operation,and Considerate Service”,our business mainly focus on the distribution of electronic components. Line cards we deal with include Microchip,ALPS,ROHM,Xilinx,Pulse,ON,Everlight and Freescale. Main products comprise IC,Modules,Potentiometer,IC Socket,Relay,Connector.Our parts cover such applications as commercial,industrial, and automotives areas.

We are looking forward to setting up business relationship with you and hope to provide you with the best service and solution. Let us make a better world for our industry!



## Contact us

Tel: +86-755-8981 8866 Fax: +86-755-8427 6832

Email & Skype: info@chipsmall.com Web: www.chipsmall.com

Address: A1208, Overseas Decoration Building, #122 Zhenhua RD., Futian, Shenzhen, China



## "High Side Chopper" IGBT SOT-227 (Trench IGBT), 100 A

**SOT-227**

PRODUCT SUMMARY	
$V_{CES}$	1200 V
$I_C$ DC	100 A at 71 °C
$V_{CE(on)}$ typical at 100 A, 25 °C	2.45 V
Package	SOT-227
Circuit	High side switch

### FEATURES

- Trench IGBT technology
- Very low  $V_{CE(on)}$
- Square RBSOA
- HEXFRED® clamping diode
- 10  $\mu$ s short circuit capability
- Fully isolated package
- Speed 4 kHz to 30 kHz
- Very low internal inductance ( $\leq 5$  nH typical)
- Industry standard outline
- UL approved file E78996 
- Material categorization: for definitions of compliance please see [www.vishay.com/doc?99912](http://www.vishay.com/doc?99912)

**RoHS  
COMPLIANT**

### BENEFITS

- Designed for increased operating efficiency in power conversion: UPS, SMPS, welding, induction heating
- Easy to assemble and parallel
- Direct mounting on heatsink
- Plug-in compatible with other SOT-227 packages
- Low EMI, requires less snubbing

ABSOLUTE MAXIMUM RATINGS				
PARAMETER	SYMBOL	TEST CONDITIONS	MAX.	UNITS
Collector to emitter voltage	$V_{CES}$		1200	V
Continuous collector current	$I_C$	$T_C = 25\text{ °C}$	134	A
		$T_C = 80\text{ °C}$	92	
Pulsed collector current	$I_{CM}$		270	
Clamped inductive load current	$I_{LM}$		270	
Diode continuous forward current	$I_F$	$T_C = 25\text{ °C}$	87	
		$T_C = 80\text{ °C}$	59	
Single pulse forward current	$I_{FSM}$	10 ms sine or 6 ms rectangular pulse, $T_J = 25\text{ °C}$	360	
Gate to emitter voltage	$V_{GE}$		$\pm 30$	V
Power dissipation, IGBT	$P_D$	$T_C = 25\text{ °C}$	463	W
		$T_C = 80\text{ °C}$	260	
Power dissipation, diode	$P_D$	$T_C = 25\text{ °C}$	338	
		$T_C = 80\text{ °C}$	190	
RMS isolation voltage	$V_{ISOL}$	Any terminal to case, $t = 1$ min	2500	V



ELECTRICAL SPECIFICATIONS (T <sub>J</sub> = 25 °C unless otherwise specified)						
PARAMETER	SYMBOL	TEST CONDITIONS	MIN.	TYP.	MAX.	UNITS
Collector to emitter breakdown voltage	V <sub>BR(CES)</sub>	V <sub>GE</sub> = 0 V, I <sub>C</sub> = 250 μA	1200	-	-	V
Collector to emitter voltage	V <sub>CE(on)</sub>	V <sub>GE</sub> = 15 V, I <sub>C</sub> = 50 A	-	1.73	2.33	
		V <sub>GE</sub> = 15 V, I <sub>C</sub> = 100 A	-	2.26	-	
		V <sub>GE</sub> = 15 V, I <sub>C</sub> = 50 A, T <sub>J</sub> = 125 °C	-	2.02	-	
		V <sub>GE</sub> = 15 V, I <sub>C</sub> = 100 A, T <sub>J</sub> = 125 °C	-	2.77	-	
Gate threshold voltage	V <sub>GE(th)</sub>	V <sub>CE</sub> = V <sub>GE</sub> , I <sub>C</sub> = 3.5 mA	4.6	5.8	8.0	
Temperature coefficient of threshold voltage	V <sub>GE(th)</sub> /ΔT <sub>J</sub>	V <sub>CE</sub> = V <sub>GE</sub> , I <sub>C</sub> = 3.5 mA (25 °C to 125 °C)	-	-14.5	-	mV/°C
Collector to emitter leakage current	I <sub>CES</sub>	V <sub>GE</sub> = 0 V, V <sub>CE</sub> = 1200 V	-	0.5	75	μA
		V <sub>GE</sub> = 0 V, V <sub>CE</sub> = 1200 V, T <sub>J</sub> = 125 °C	-	0.12	-	mA
Diode reverse breakdown voltage	V <sub>BR</sub>	I <sub>R</sub> = 1 mA	1200	-	-	V
Diode forward voltage drop	V <sub>FM</sub>	I <sub>F</sub> = 50 A, V <sub>GE</sub> = 0 V	-	2.65	3.55	V
		I <sub>F</sub> = 100 A, V <sub>GE</sub> = 0 V	-	3.5	-	
		I <sub>F</sub> = 50 A, V <sub>GE</sub> = 0 V, T <sub>J</sub> = 125 °C	-	2.82	-	
		I <sub>F</sub> = 100 A, V <sub>GE</sub> = 0 V, T <sub>J</sub> = 125 °C	-	3.9	-	
Diode reverse leakage current	I <sub>RM</sub>	V <sub>R</sub> = 1200 V	-	4	50	μA
		T <sub>J</sub> = 125 °C, V <sub>R</sub> = 1200 V	-	0.8	-	mA
Gate to emitter leakage current	I <sub>GES</sub>	V <sub>GE</sub> = ± 30 V	-	-	± 600	nA

SWITCHING CHARACTERISTICS (T <sub>J</sub> = 25 °C unless otherwise specified)						
PARAMETER	SYMBOL	TEST CONDITIONS	MIN.	TYP.	MAX.	UNITS
Total gate charge (turn-on)	Q <sub>g</sub>	I <sub>C</sub> = 100 A, V <sub>CC</sub> = 600 V, V <sub>GE</sub> = 15 V	-	400	-	nC
Gate to emitter charge (turn-on)	Q <sub>ge</sub>		-	120	-	
Gate to collector charge (turn-on)	Q <sub>gc</sub>		-	170	-	
Turn-on switching loss	E <sub>on</sub>	I <sub>C</sub> = 100 A, V <sub>CC</sub> = 600 V, V <sub>GE</sub> = 15 V, R <sub>g</sub> = 2.2 Ω, L = 500 μH	-	4.76	-	mJ
Turn-off switching loss	E <sub>off</sub>		-	3.64	-	
Total switching loss	E <sub>tot</sub>		-	8.4	-	
Turn-on switching loss	E <sub>on</sub>		-	6.88	-	
Turn-off switching loss	E <sub>off</sub>		-	5.66	-	
Total switching loss	E <sub>tot</sub>		-	12.54	-	
Turn-on delay time	t <sub>d(on)</sub>	I <sub>C</sub> = 100 A, V <sub>CC</sub> = 600 V, V <sub>GE</sub> = 15 V, R <sub>g</sub> = 2.2 Ω, L = 500 μH, T <sub>J</sub> = 125 °C	-	150	-	ns
Rise time	t <sub>r</sub>		-	55	-	
Turn-off delay time	t <sub>d(off)</sub>		-	164	-	
Fall time	t <sub>f</sub>		-	167	-	
Reverse bias safe operating area	RBSOA	T <sub>J</sub> = 150 °C, I <sub>C</sub> = 270 A, R <sub>g</sub> = 22 Ω, V <sub>GE</sub> = 15 V to 0 V, V <sub>CC</sub> = 900 V, V <sub>P</sub> = 1200 V	Fullsquare			
Short circuit safe operating area	SCSOA	T <sub>J</sub> = 150 °C, R <sub>g</sub> = 22 Ω, V <sub>GE</sub> = 15 V to 0 V, V <sub>CC</sub> = 900 V, V <sub>P</sub> = 1200 V	10			μs
Diode reverse recovery time	t <sub>rr</sub>	I <sub>F</sub> = 50 A, dI <sub>F</sub> /dt = 200 A/μs, V <sub>R</sub> = 200 V	-	129	-	ns
Diode peak reverse current	I <sub>rr</sub>		-	11	-	A
Diode recovery charge	Q <sub>rr</sub>		-	710	-	nC
Diode reverse recovery time	t <sub>rr</sub>	I <sub>F</sub> = 50 A, dI <sub>F</sub> /dt = 200 A/μs, V <sub>R</sub> = 200 V, T <sub>J</sub> = 125 °C	-	208	-	ns
Diode peak reverse current	I <sub>rr</sub>		-	17	-	A
Diode recovery charge	Q <sub>rr</sub>		-	1768	-	nC



THERMAL AND MECHANICAL SPECIFICATIONS						
PARAMETER	SYMBOL		MIN.	TYP.	MAX.	UNITS
Junction and storage temperature range	$T_J, T_{Stg}$		-40	-	150	°C
Junction to case	IGBT	$R_{thJC}$	-	-	0.27	°C/W
	Diode		-	-	0.37	
Case to heatsink	$R_{thCS}$	Flat, greased surface	-	0.05	-	
Weight			-	30	-	g
Mounting torque		Torque to terminal	-	-	1.1 (9.7)	Nm (lbf.in)
		Torque to heatsink	-	-	1.3 (11.5)	Nm (lbf.in)
Case style	SOT-227					

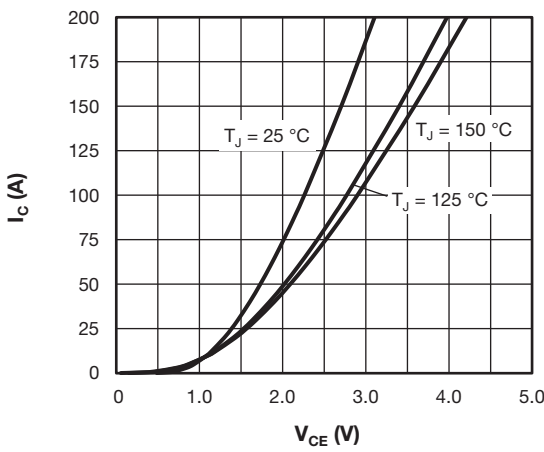

Fig. 1 - Typical IGBT Output Characteristics,  $V_{GE} = 15\text{ V}$

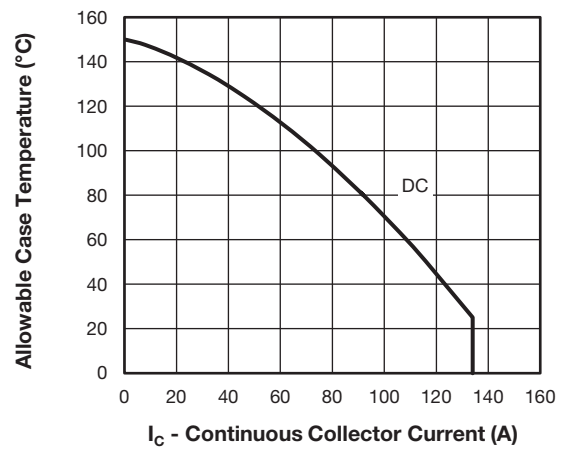

Fig. 3 - Maximum IGBT Continuous Collector Current vs. Case Temperature

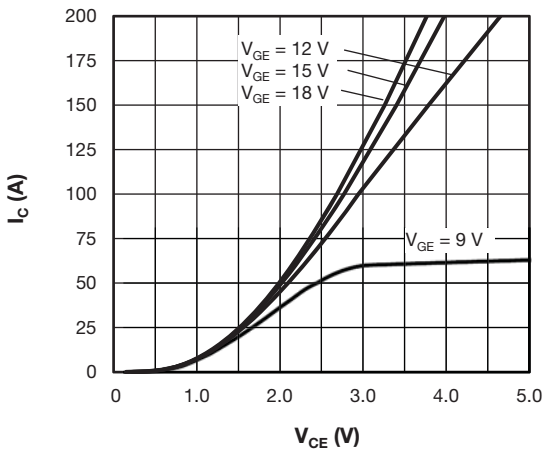

Fig. 2 - Typical IGBT Output Characteristics,  $T_J = 125\text{ °C}$

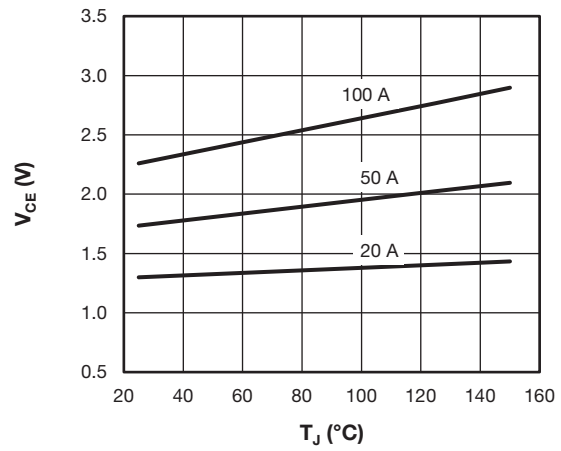

Fig. 4 - Collector to Emitter Voltage vs. Junction Temperature

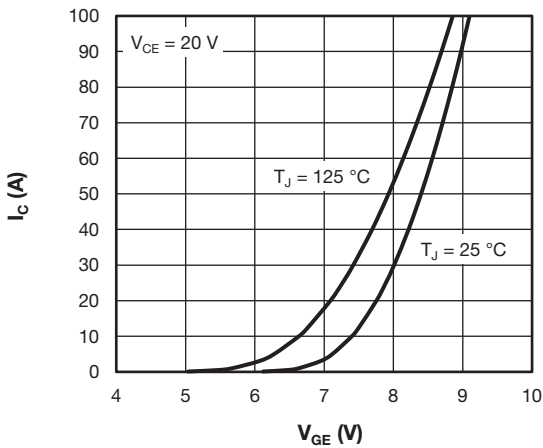

Fig. 5 - Typical IGBT Transfer Characteristics

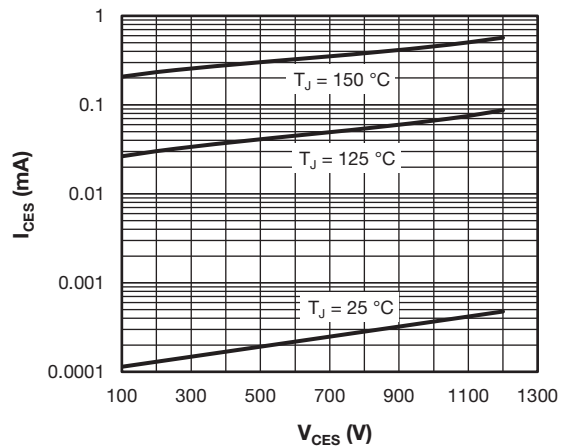

Fig. 8 - Typical IGBT Zero Gate Voltage Collector Current

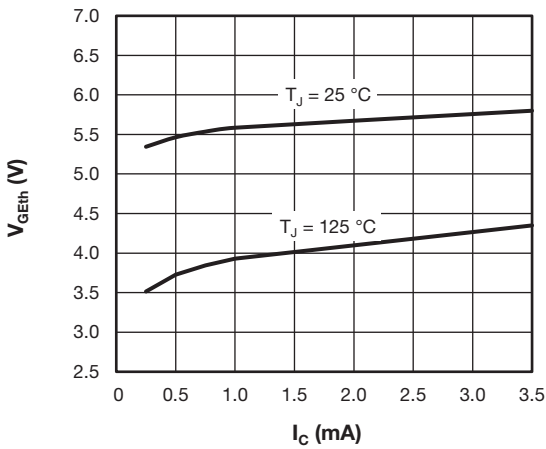

Fig. 6 - Typical IGBT Gate Threshold Voltage

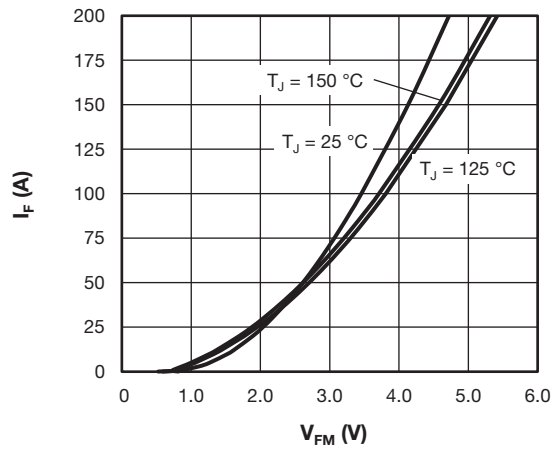

Fig. 9 - Typical Diode Forward Characteristics

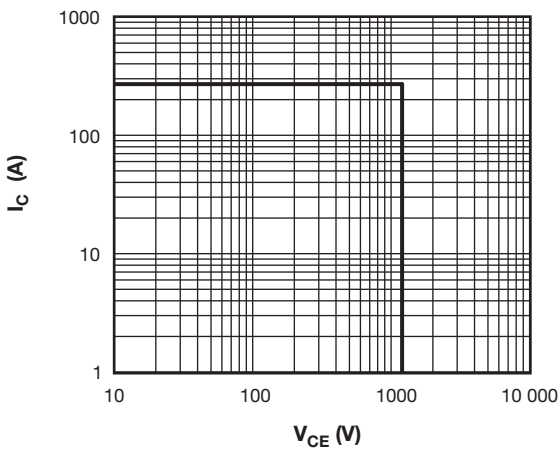

Fig. 7 - IGBT Reverse Bias SOA  $T_J = 150\text{ }^\circ\text{C}$ ,  $V_{GE} = 15\text{ V}$

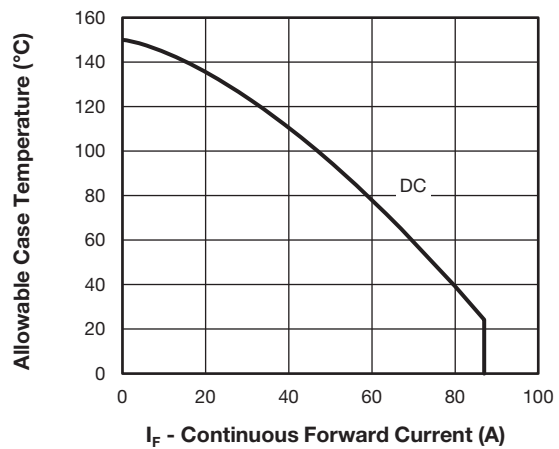

Fig. 10 - Maximum Diode Continuous Forward Current vs. Case Temperature

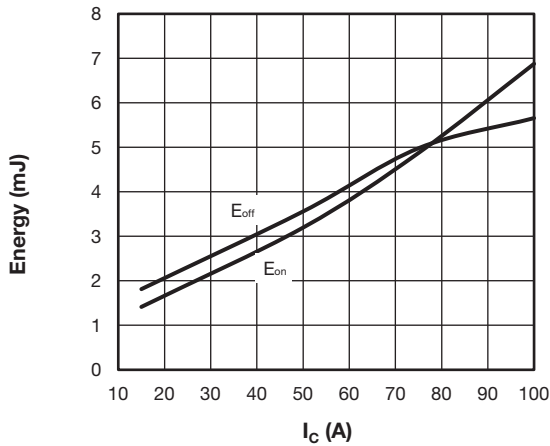

Fig. 11 - Typical IGBT Energy Loss vs.  $I_C$   
 $T_J = 125^\circ\text{C}$ ,  $V_{CC} = 600\text{ V}$ ,  $R_g = 2.2\ \Omega$ ,  $V_{GE} = 15\text{ V}$ ,  $L = 500\ \mu\text{H}$

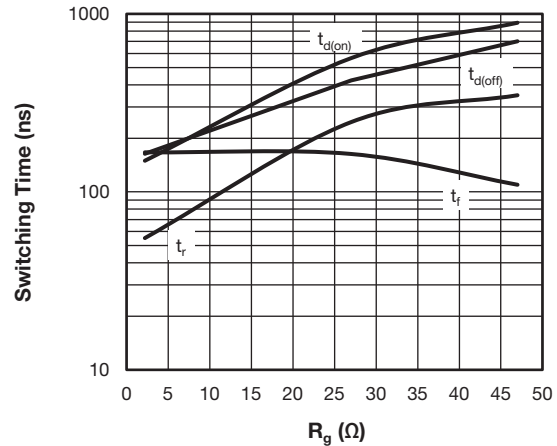

Fig. 14 - Typical IGBT Switching Time vs.  $R_g$   
 $T_J = 125^\circ\text{C}$ ,  $V_{CC} = 600\text{ V}$ ,  $I_C = 100\text{ A}$ ,  $V_{GE} = 15\text{ V}$ ,  $L = 500\ \mu\text{H}$

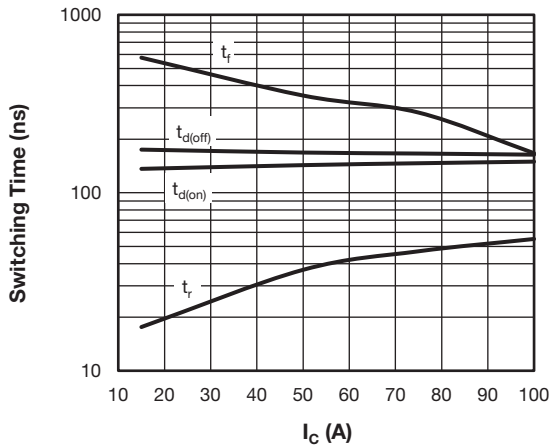

Fig. 12 - Typical IGBT Switching Time vs.  $I_C$   
 $T_J = 125^\circ\text{C}$ ,  $V_{CC} = 600\text{ V}$ ,  $R_g = 2.2\ \Omega$ ,  $V_{GE} = 15\text{ V}$ ,  $L = 500\ \mu\text{H}$

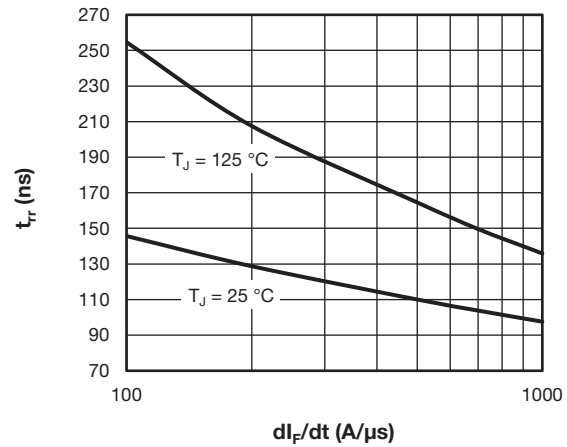

Fig. 15 - Typical Diode Reverse Recovery Time vs.  $di_F/dt$   
 $V_{rr} = 200\text{ V}$ ,  $I_F = 50\text{ A}$

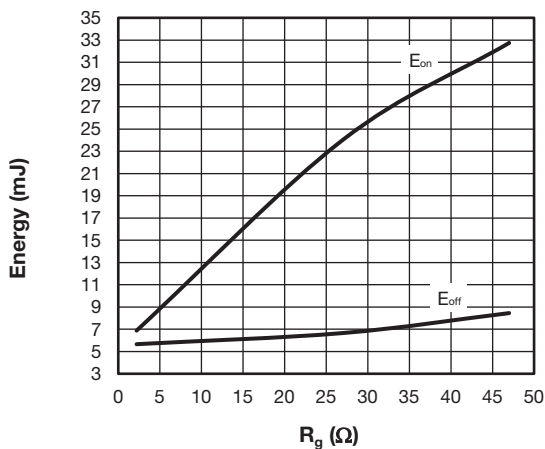

Fig. 13 - Typical IGBT Energy Loss vs.  $R_g$   
 $T_J = 125^\circ\text{C}$ ,  $V_{CC} = 600\text{ V}$ ,  $I_C = 100\text{ A}$ ,  $V_{GE} = 15\text{ V}$ ,  $L = 500\ \mu\text{H}$

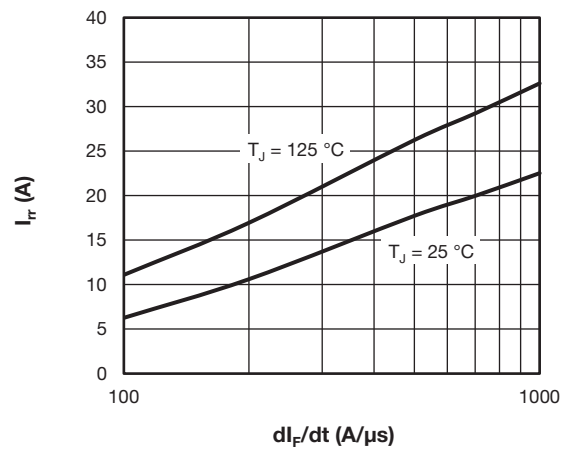

Fig. 16 - Typical Diode Reverse Recovery Current vs.  $di_F/dt$   
 $V_{rr} = 200\text{ V}$ ,  $I_F = 50\text{ A}$

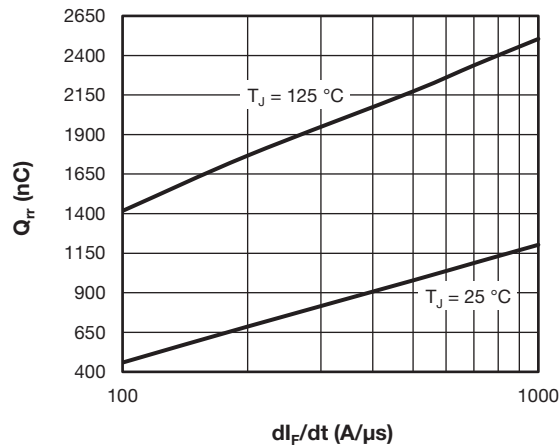

Fig. 17 - Typical Diode Reverse Recovery Charge vs.  $di_F/dt$   
 $V_{rr} = 200\text{ V}$ ,  $I_F = 50\text{ A}$

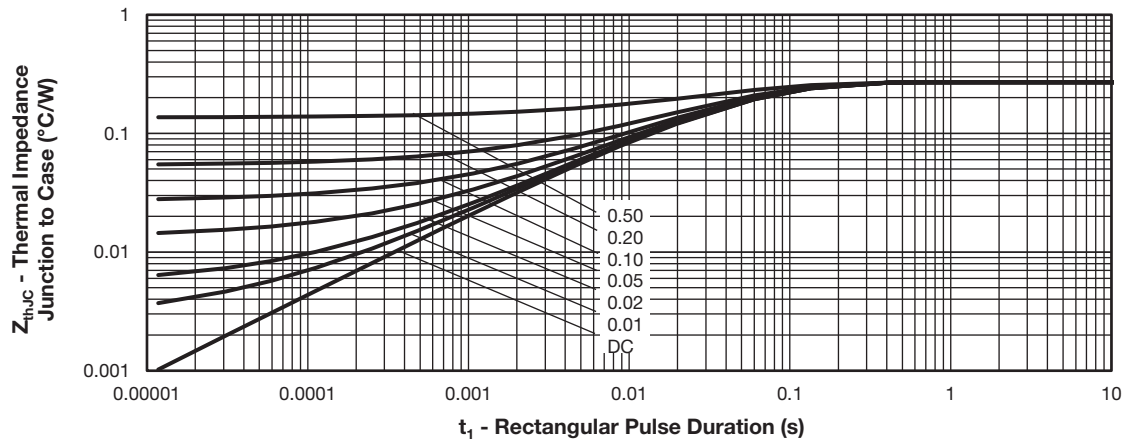

Fig. 18 - Maximum Thermal Impedance  $Z_{thJC}$  Characteristics - (IGBT)

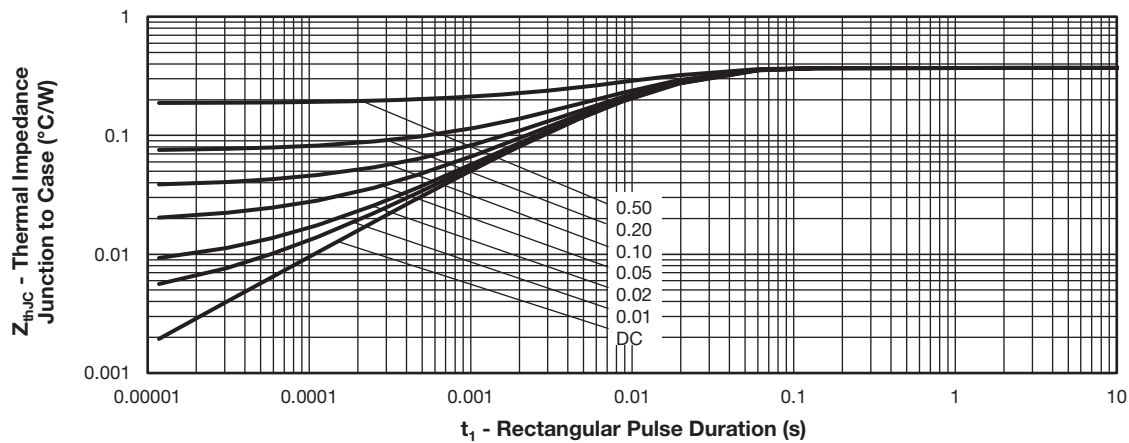

Fig. 19 - Maximum Thermal Impedance  $Z_{thJC}$  Characteristics - (Diode)

**ORDERING INFORMATION TABLE**

Device code	<b>VS-</b>	<b>G</b>	<b>T</b>	<b>105</b>	<b>N</b>	<b>A</b>	<b>120</b>	<b>U</b>	<b>X</b>
	①	②	③	④	⑤	⑥	⑦	⑧	⑨

- 1** - Vishay Semiconductors product
- 2** - Insulated Gate Bipolar Transistor (IGBT)
- 3** - T = Trench IGBT
- 4** - Current rating (105 = 100 A)
- 5** - Circuit configuration (N = high side chopper)
- 6** - Package indicator (A = SOT-227)
- 7** - Voltage rating (120 = 1200 V)
- 8** - Speed/type (U = ultrafast IGBT)
- 9** - Diode (X = HEXFRED®)

<b>CIRCUIT CONFIGURATION</b>		
CIRCUIT	CIRCUIT CONFIGURATION CODE	CIRCUIT DRAWING
High side chopper IGBT	N	

<b>LINKS TO RELATED DOCUMENTS</b>	
Dimensions	<a href="http://www.vishay.com/doc?95423">www.vishay.com/doc?95423</a>
Packaging information	<a href="http://www.vishay.com/doc?95425">www.vishay.com/doc?95425</a>





**DIMENSIONS** in millimeters (inches)

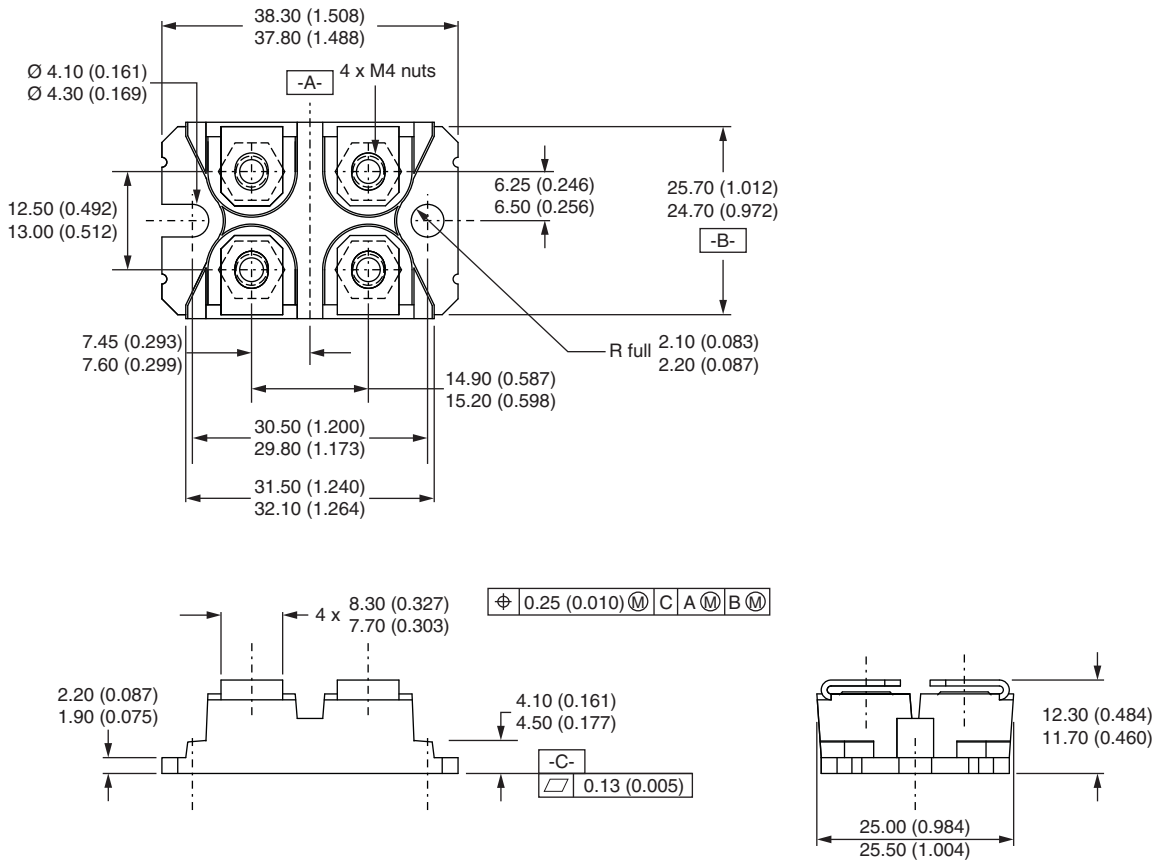

**Note**

- Controlling dimension: millimeter

**PACKAGING INFORMATION SOT-227 GENERATION II**

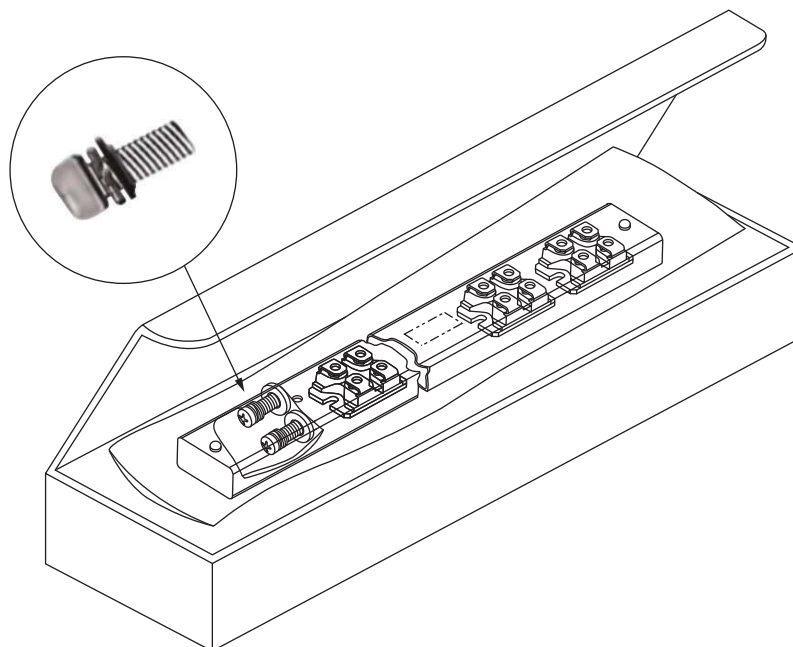



## **Disclaimer**

ALL PRODUCT, PRODUCT SPECIFICATIONS AND DATA ARE SUBJECT TO CHANGE WITHOUT NOTICE TO IMPROVE RELIABILITY, FUNCTION OR DESIGN OR OTHERWISE.

Vishay Intertechnology, Inc., its affiliates, agents, and employees, and all persons acting on its or their behalf (collectively, "Vishay"), disclaim any and all liability for any errors, inaccuracies or incompleteness contained in any datasheet or in any other disclosure relating to any product.

Vishay makes no warranty, representation or guarantee regarding the suitability of the products for any particular purpose or the continuing production of any product. To the maximum extent permitted by applicable law, Vishay disclaims (i) any and all liability arising out of the application or use of any product, (ii) any and all liability, including without limitation special, consequential or incidental damages, and (iii) any and all implied warranties, including warranties of fitness for particular purpose, non-infringement and merchantability.

Statements regarding the suitability of products for certain types of applications are based on Vishay's knowledge of typical requirements that are often placed on Vishay products in generic applications. Such statements are not binding statements about the suitability of products for a particular application. It is the customer's responsibility to validate that a particular product with the properties described in the product specification is suitable for use in a particular application. Parameters provided in datasheets and / or specifications may vary in different applications and performance may vary over time. All operating parameters, including typical parameters, must be validated for each customer application by the customer's technical experts. Product specifications do not expand or otherwise modify Vishay's terms and conditions of purchase, including but not limited to the warranty expressed therein.

Except as expressly indicated in writing, Vishay products are not designed for use in medical, life-saving, or life-sustaining applications or for any other application in which the failure of the Vishay product could result in personal injury or death. Customers using or selling Vishay products not expressly indicated for use in such applications do so at their own risk. Please contact authorized Vishay personnel to obtain written terms and conditions regarding products designed for such applications.

No license, express or implied, by estoppel or otherwise, to any intellectual property rights is granted by this document or by any conduct of Vishay. Product names and markings noted herein may be trademarks of their respective owners.