



Chipsmall Limited consists of a professional team with an average of over 10 year of expertise in the distribution of electronic components. Based in Hongkong, we have already established firm and mutual-benefit business relationships with customers from,Europe,America and south Asia,supplying obsolete and hard-to-find components to meet their specific needs.

With the principle of "Quality Parts,Customers Priority,Honest Operation,and Considerate Service",our business mainly focus on the distribution of electronic components. Line cards we deal with include Microchip,ALPS,ROHM,Xilinx,Pulse,ON,Everlight and Freescale. Main products comprise IC,Modules,Potentiometer,IC Socket,Relay,Connector.Our parts cover such applications as commercial,industrial, and automotives areas.

We are looking forward to setting up business relationship with you and hope to provide you with the best service and solution. Let us make a better world for our industry!



Contact us

Tel: +86-755-8981 8866 Fax: +86-755-8427 6832

Email & Skype: info@chipsmall.com Web: www.chipsmall.com

Address: A1208, Overseas Decoration Building, #122 Zhenhua RD., Futian, Shenzhen, China





Inverter Grade Thyristors (Stud Version), 300 A



TO- 209AE (TO-118)

FEATURES

- Center amplifying gate
- High surge current capability
- Low thermal impedance
- High speed performance
- Compression bonding
- Designed and qualified for industrial level
- Material categorization: for definitions of compliance please see www.vishay.com/doc?99912



RoHS COMPLIANT

PRODUCT SUMMARY	
$I_{T(AV)}$	300 A
V_{DRM}/V_{RRM}	400 V, 1200 V
V_{TM}	2.16 V
I_{TSM} at 50 Hz	3000 A
I_{TSM} at 60 Hz	3150 A
I_{GT}	200 mA
T_J	-40 °C to 125 °C
Package	TO-209AE (TO-118)
Diode variation	Single SCR

TYPICAL APPLICATIONS

- Inverters
- Choppers
- Induction heating
- All types of force-commutated converters

MAJOR RATINGS AND CHARACTERISTICS			
PARAMETER	TEST CONDITIONS	VALUES	UNITS
$I_{T(AV)}$		300	A
	T_C	65	°C
$I_{T(RMS)}$		471	A
I_{TSM}	50 Hz	7950	
	60 Hz	8320	
I^2t	50 Hz	316	kA ² s
	60 Hz	288	
V_{DRM}/V_{RRM}		400 to 1200	V
t_q		10/20	μs
T_J		-40 to 125	°C

ELECTRICAL SPECIFICATIONS

VOLTAGE RATINGS				
TYPE NUMBER	VOLTAGE CODE	V_{DRM}/V_{RRM} , MAXIMUM REPETITIVE PEAK VOLTAGE V	V_{RSM} , MAXIMUM NON-REPETITIVE PEAK VOLTAGE V	I_{DRM}/I_{RRM} MAXIMUM AT $T_J = T_J$ MAXIMUM mA
VS-ST303S	04	400	500	50
	08	800	900	
	12	1200	1300	



CURRENT CARRYING CAPABILITY							
FREQUENCY							UNITS
50 Hz	670	470	1050	940	5240	4300	A
400 Hz	480	330	1021	710	1800	1270	
1000 Hz	230	140	760	470	730	430	
2500 Hz	35	-	150	-	90	-	
Recovery voltage V_R	50		50		50		V
Voltage before turn-on V_D	V_{DRM}		V_{DRM}		V_{DRM}		
Rise of on-state current di/dt	50		-		-		A/μs
Case temperature	40	65	40	65	40	65	°C
Equivalent values for RC circuit	10/0.47		10/0.47		10/0.47		Ω/μF

ON-STATE CONDUCTION					
PARAMETER	SYMBOL	TEST CONDITIONS		VALUES	UNITS
Maximum average on-state current at case temperature	$I_{T(AV)}$	180° conduction, half sine wave		300	A
				65	°C
Maximum RMS on-state current	$I_{T(RMS)}$	DC at 45 °C case temperature		471	
Maximum peak, one half cycle, non-repetitive surge current	I_{TSM}	t = 10 ms	No voltage reapplied	7950	A
				t = 8.3 ms	
		t = 10 ms	100 % V_{RRM} reapplied	6690	
				t = 8.3 ms	
Maximum I^2t for fusing	I^2t	t = 10 ms	No voltage reapplied	316	kA ² s
				t = 8.3 ms	
		t = 10 ms	100 % V_{RRM} reapplied	224	
				t = 8.3 ms	
Maximum $I^2\sqrt{t}$ for fusing	$I^2\sqrt{t}$	t = 0.1 ms to 10 ms, no voltage reapplied		3160	kA ² √s
Maximum peak on-state voltage	V_{TM}	$I_{TM} = 1255$ A, $T_J = T_J$ maximum, $t_p = 10$ ms sine wave pulse		2.16	V
Low level value of threshold voltage	$V_{T(TO)1}$	$(16.7\% \times \pi \times I_{T(AV)}) < I < \pi \times I_{T(AV)}$, $T_J = T_J$ maximum		1.44	
High level value of threshold voltage	$V_{T(TO)2}$	$I > \pi \times I_{T(AV)}$, $T_J = T_J$ maximum		1.46	
Low level value of forward slope resistance	r_{t1}	$(16.7\% \times \pi \times I_{T(AV)}) < I < \pi \times I_{T(AV)}$, $T_J = T_J$ maximum		0.57	mΩ
High level value of forward slope resistance	r_{t2}	$I > \pi \times I_{T(AV)}$, $T_J = T_J$ maximum		0.56	
Maximum holding current	I_H	$T_J = 25$ °C, $I_T > 30$ A		600	mA
Typical latching current	I_L	$T_J = 25$ °C, $V_A = 12$ V, $R_a = 6$ Ω, $I_G = 1$ A		1000	

SWITCHING					
PARAMETER	SYMBOL	TEST CONDITIONS		VALUES	UNITS
Maximum non-repetitive rate of rise of turned-on current	di/dt	$T_J = T_J$ maximum, $V_{DRM} = \text{Rated } V_{DRM}$ $I_{TM} = 2 \times di/dt$		1000	A/μs
Typical delay time	t_d	$T_J = 25$ °C, $V_{DM} = \text{Rated } V_{DRM}$, $I_{TM} = 50$ A DC, $t_p = 1$ μs Resistive load, gate pulse: 10 V, 5 Ω source		0.80	μs
Maximum turn-off time	minimum	$T_J = T_J$ maximum, $I_{TM} = 550$ A, commutating $di/dt = 40$ A/μs $V_R = 50$ V, $t_p = 500$ μs, $dV/dt = 200$ V/μs		10	
	maximum			t_q	20



BLOCKING				
PARAMETER	SYMBOL	TEST CONDITIONS	VALUES	UNITS
Maximum critical rate of rise of off-state voltage	dV/dt	$T_J = T_J$ maximum, linear to 80 % V_{DRM} , higher value available on request	500	V/ μ s
Maximum peak reverse and off-state leakage current	I_{RRM} , I_{DRM}	$T_J = T_J$ maximum, rated V_{DRM}/V_{RRM} applied	50	mA

TRIGGERING				
PARAMETER	SYMBOL	TEST CONDITIONS	VALUES	UNITS
Maximum peak gate power	P_{GM}	$T_J = T_J$ maximum, $f = 50$ Hz, $d\% = 50$	60	W
Maximum average gate power	$P_{G(AV)}$		10	
Maximum peak positive gate current	I_{GM}	$T_J = T_J$ maximum, $t_p \leq 5$ ms	10	A
Maximum peak positive gate voltage	+ V_{GM}		20	V
Maximum peak negative gate voltage	- V_{GM}		5	
Maximum DC gate current required to trigger	I_{GT}		$T_J = 25$ °C, $V_A = 12$ V, $R_a = 6$ Ω	200
Maximum DC gate voltage required to trigger	V_{GT}	3		V
Maximum DC gate current not to trigger	I_{GD}	$T_J = T_J$ maximum, rated V_{DRM} applied	20	mA
Maximum DC gate voltage not to trigger	V_{GD}		0.25	V

THERMAL AND MECHANICAL SPECIFICATIONS				
PARAMETER	SYMBOL	TEST CONDITIONS	VALUES	UNITS
Maximum operating junction temperature range	T_J		-40 to +125	°C
Maximum storage temperature range	T_{Stg}		-40 to +150	
Maximum thermal resistance, junction to case	R_{thJC}	DC operation	0.10	K/W
Maximum thermal resistance, case to heatsink	R_{thCS}	Mounting surface, smooth, flat and greased	0.03	
Mounting force, ± 10 %		Non-lubricated threads	48.5 (425)	N · m (lb · in)
Approximate weight			535	g
Case style		See dimensions - link at the end of datasheet	TO-209AE (TO-118)	

ΔR_{thJ-hs} CONDUCTION				
CONDUCTION ANGLE	SINUSOIDAL CONDUCTION	RECTANGULAR CONDUCTION	TEST CONDITIONS	UNITS
180°	0.011	0.008	$T_J = T_J$ maximum	K/W
120°	0.013	0.014		
90°	0.017	0.018		
60°	0.025	0.026		
30°	0.041	0.042		

Note

- The table above shows the increment of thermal resistance R_{thJ-hs} when devices operate at different conduction angles than DC

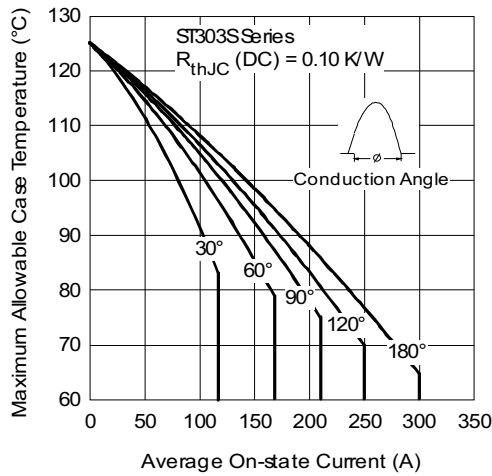

Fig. 1 - Current Ratings Characteristics

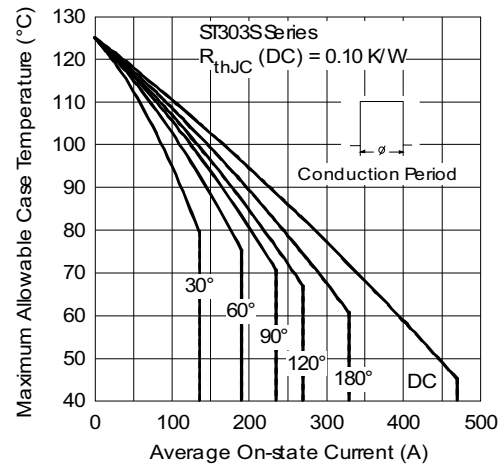

Fig. 2 - Current Ratings Characteristics

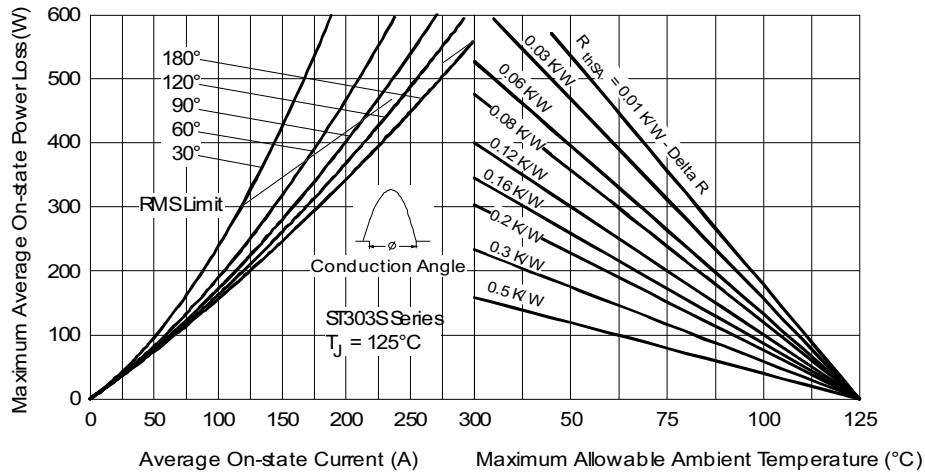

Fig. 3 - On-State Power Loss Characteristics

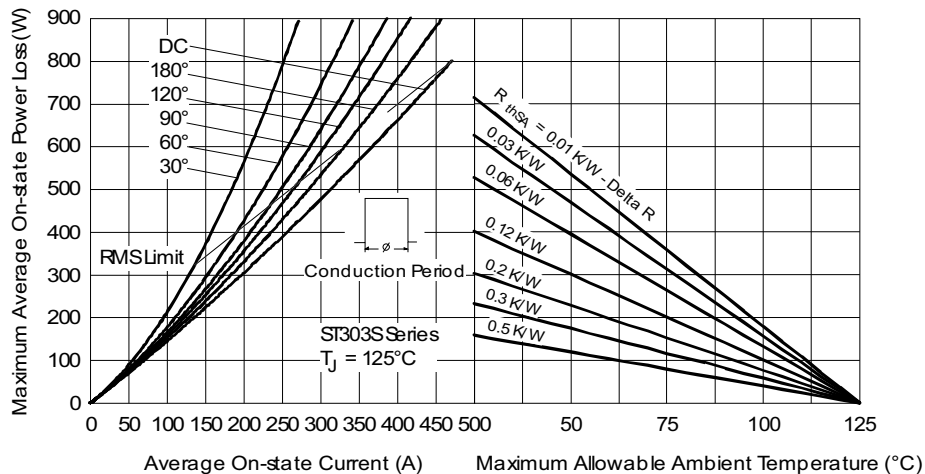

Fig. 4 - On-State Power Loss Characteristics

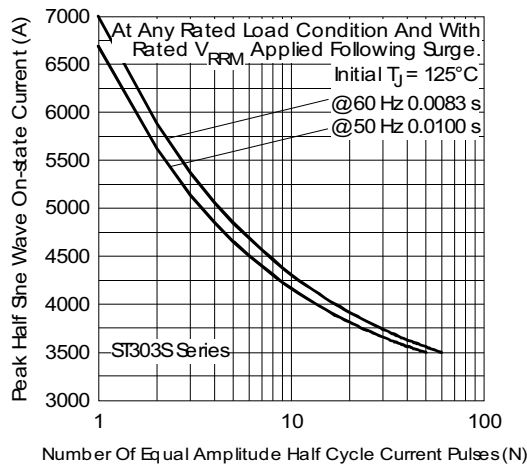

Fig. 5 - Maximum Non-Repetitive Surge Current

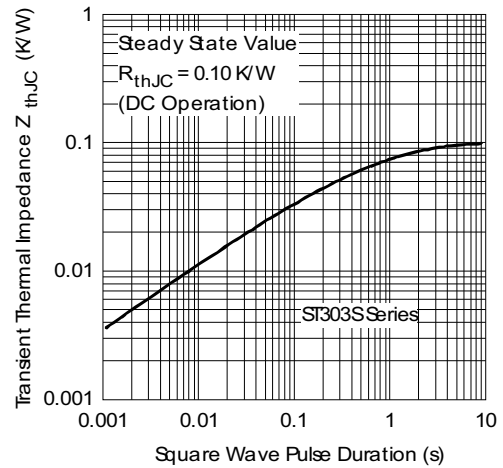

Fig. 8 - Thermal Impedance Z_{thJC} Characteristics

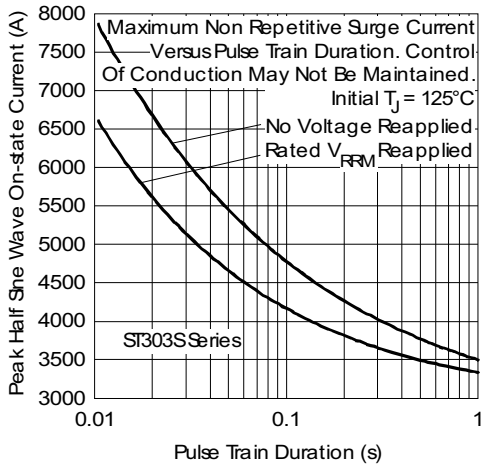

Fig. 6 - Maximum Non-Repetitive Surge Current

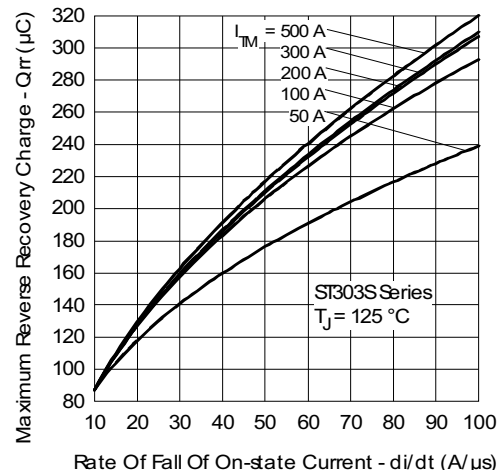

Fig. 9 - Reverse Recovered Charge Characteristics

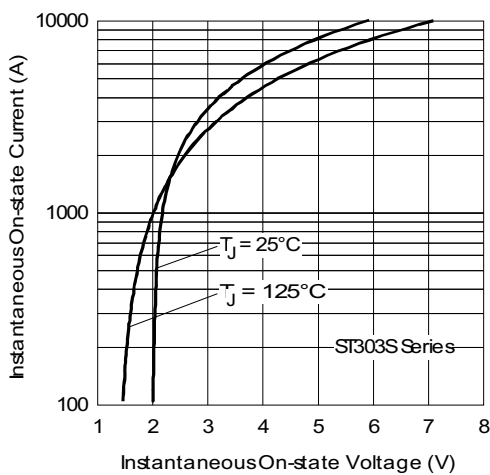

Fig. 7 - On-State Voltage Drop Characteristics

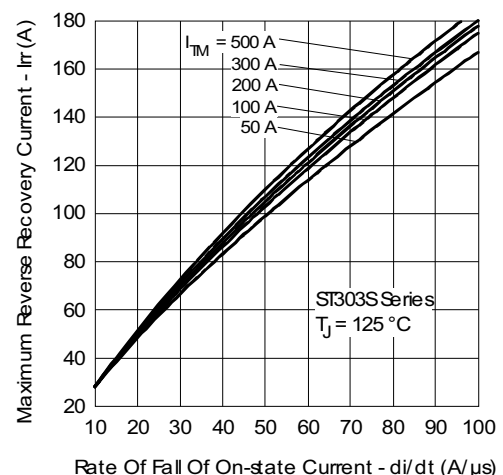

Fig. 10 - Reverse Recovery Current Characteristics

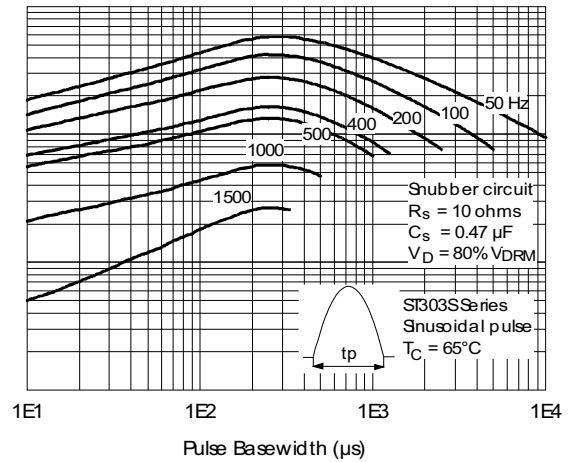
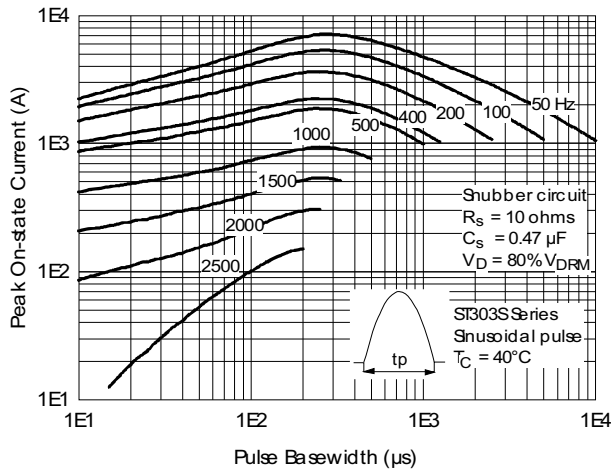

Fig. 11 - Frequency Characteristics

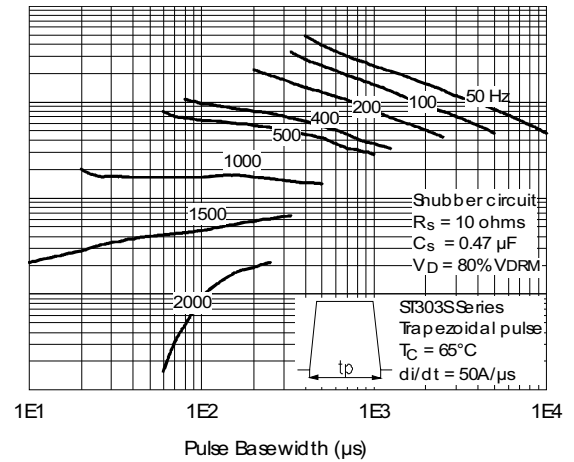
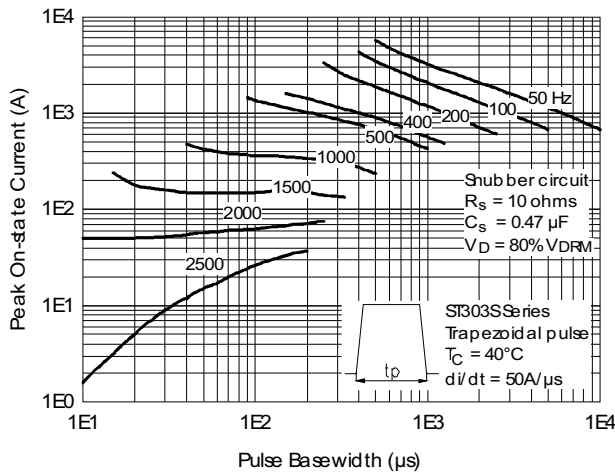

Fig. 12 - Frequency Characteristics

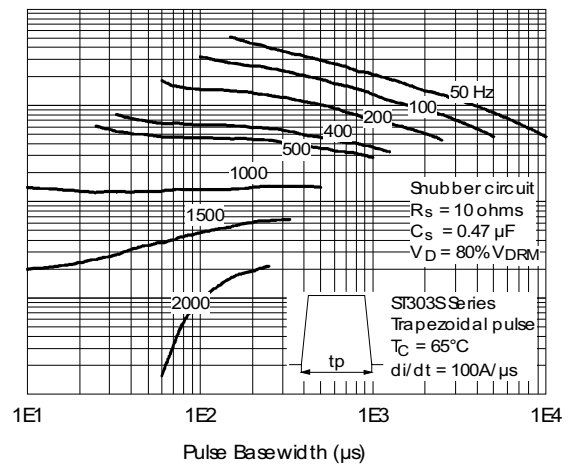
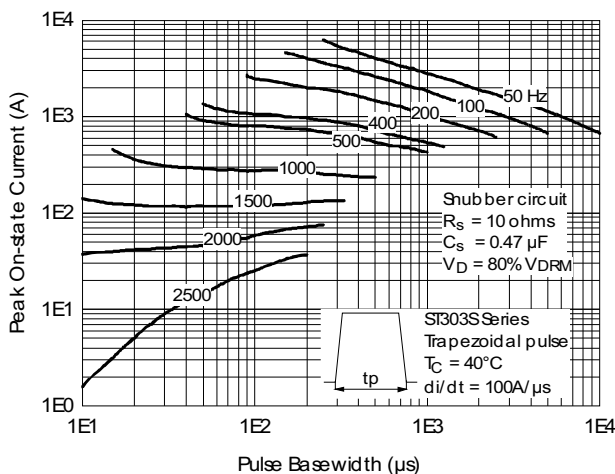

Fig. 13 - Frequency Characteristics

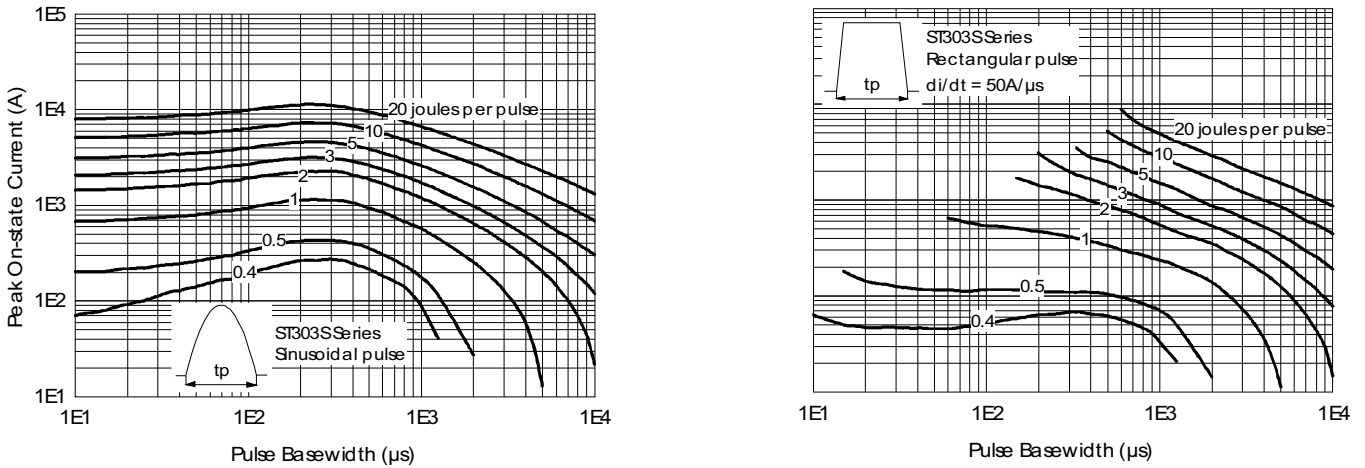

Fig. 14 - Maximum On-State Energy Power Loss Characteristics

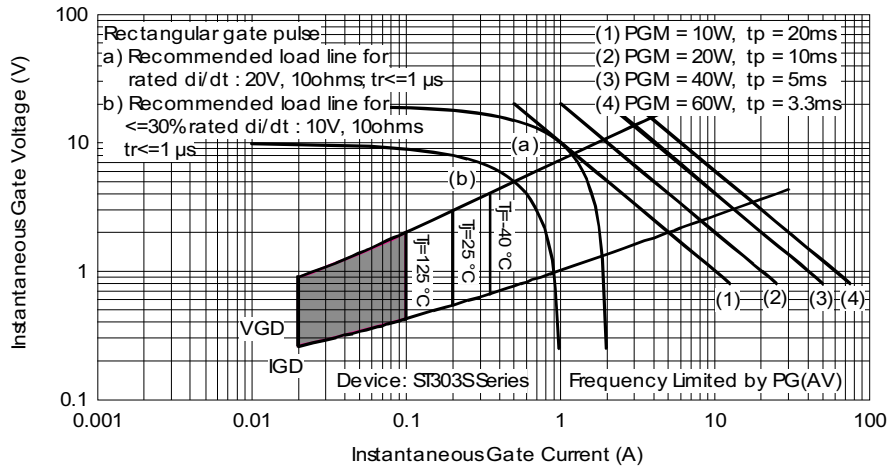
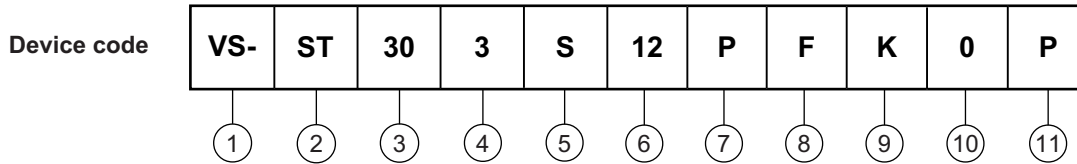

Fig. 15 - Gate Characteristics



ORDERING INFORMATION TABLE



- 1** - Vishay Semiconductors product
- 2** - Thyristor
- 3** - Essential part number
- 4** - 3 = fast turn-off
- 5** - S = compression bonding stud
- 6** - Voltage code x 100 = V_{RRM}
(see Voltage Ratings table)
- 7** - P = stud base 3/4" 16UNF-2A
- 8** - Reapplied dV/dt code (for t_q test condition)
- 9** - t_q code
- 10** - 0 = eyelet terminals
(gate and auxiliary cathode leads)
1 = fast-on terminals
(gate and auxiliary cathode leads)
- 11** - None = standard production
P = lead (Pb)-free

dV/dt - t_q combinations available		
	dV/dt (V/ μ s)	200
t_q (μ s) up to 800 V	10	FN
	15	FL
	20	FK
t_q (μ s) only for 1000/1200 V	20	FK

LINKS TO RELATED DOCUMENTS	
Dimensions	www.vishay.com/doc?95080

TO-209AE (TO-118)

DIMENSIONS in millimeters (inches)

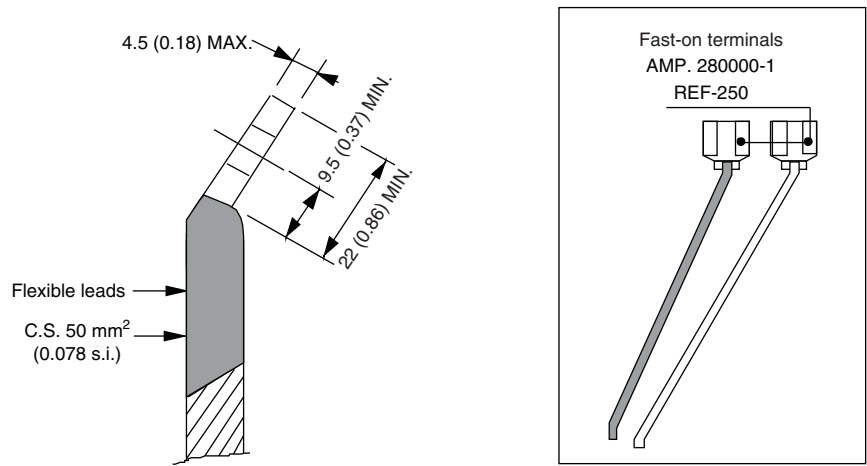
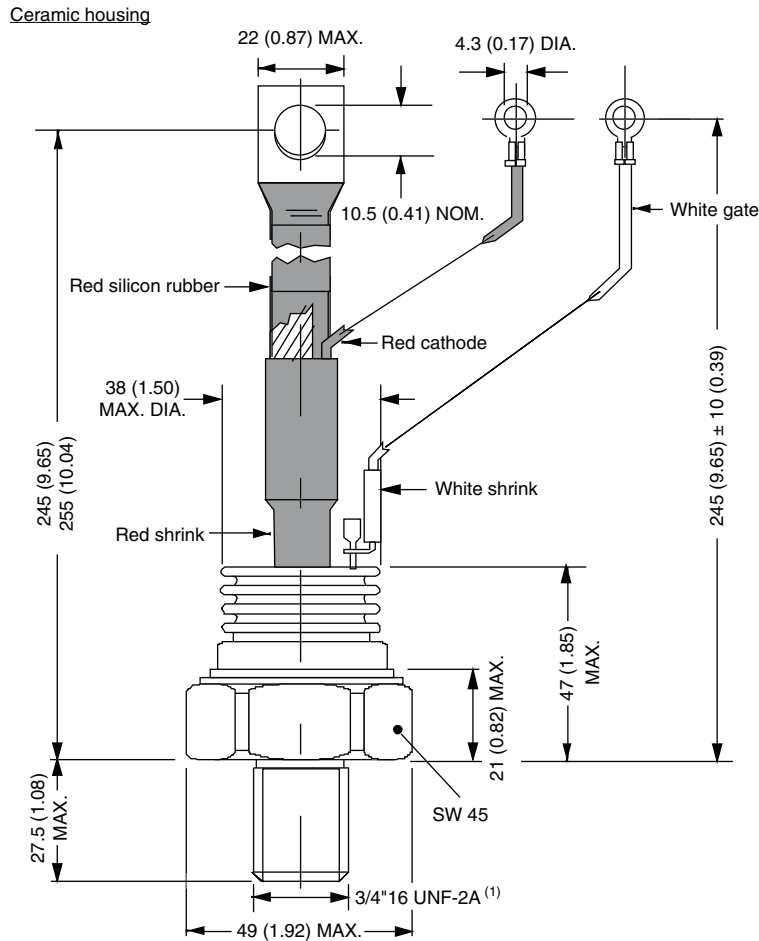

Note

⁽¹⁾ For metric device: M24 x 1.5 - length 21 (0.83) maximum



Disclaimer

ALL PRODUCT, PRODUCT SPECIFICATIONS AND DATA ARE SUBJECT TO CHANGE WITHOUT NOTICE TO IMPROVE RELIABILITY, FUNCTION OR DESIGN OR OTHERWISE.

Vishay Intertechnology, Inc., its affiliates, agents, and employees, and all persons acting on its or their behalf (collectively, "Vishay"), disclaim any and all liability for any errors, inaccuracies or incompleteness contained in any datasheet or in any other disclosure relating to any product.

Vishay makes no warranty, representation or guarantee regarding the suitability of the products for any particular purpose or the continuing production of any product. To the maximum extent permitted by applicable law, Vishay disclaims (i) any and all liability arising out of the application or use of any product, (ii) any and all liability, including without limitation special, consequential or incidental damages, and (iii) any and all implied warranties, including warranties of fitness for particular purpose, non-infringement and merchantability.

Statements regarding the suitability of products for certain types of applications are based on Vishay's knowledge of typical requirements that are often placed on Vishay products in generic applications. Such statements are not binding statements about the suitability of products for a particular application. It is the customer's responsibility to validate that a particular product with the properties described in the product specification is suitable for use in a particular application. Parameters provided in datasheets and / or specifications may vary in different applications and performance may vary over time. All operating parameters, including typical parameters, must be validated for each customer application by the customer's technical experts. Product specifications do not expand or otherwise modify Vishay's terms and conditions of purchase, including but not limited to the warranty expressed therein.

Except as expressly indicated in writing, Vishay products are not designed for use in medical, life-saving, or life-sustaining applications or for any other application in which the failure of the Vishay product could result in personal injury or death. Customers using or selling Vishay products not expressly indicated for use in such applications do so at their own risk. Please contact authorized Vishay personnel to obtain written terms and conditions regarding products designed for such applications.

No license, express or implied, by estoppel or otherwise, to any intellectual property rights is granted by this document or by any conduct of Vishay. Product names and markings noted herein may be trademarks of their respective owners.