



Chipsmall Limited consists of a professional team with an average of over 10 year of expertise in the distribution of electronic components. Based in Hongkong, we have already established firm and mutual-benefit business relationships with customers from,Europe,America and south Asia,supplying obsolete and hard-to-find components to meet their specific needs.

With the principle of “Quality Parts,Customers Priority,Honest Operation,and Considerate Service”,our business mainly focus on the distribution of electronic components. Line cards we deal with include Microchip,ALPS,ROHM,Xilinx,Pulse,ON,Everlight and Freescale. Main products comprise IC,Modules,Potentiometer,IC Socket,Relay,Connector.Our parts cover such applications as commercial,industrial, and automotives areas.

We are looking forward to setting up business relationship with you and hope to provide you with the best service and solution. Let us make a better world for our industry!



Contact us

Tel: +86-755-8981 8866 Fax: +86-755-8427 6832

Email & Skype: info@chipsmall.com Web: www.chipsmall.com

Address: A1208, Overseas Decoration Building, #122 Zhenhua RD., Futian, Shenzhen, China





Standard Recovery Diodes, 250 A to 320 A (MAGN-A-PAK Power Modules)



MAGN-A-PAK

FEATURES

- High voltage
- Electrically isolated base plate
- 3000 V_{RMS} isolating voltage
- Industrial standard package
- Simplified mechanical designs, rapid assembly
- High surge capability
- Large creepage distances
- UL approved file E78996 
- Designed and qualified for industrial level
- Material categorization: for definitions of compliance please see www.vishay.com/doc?99912



RoHS
COMPLIANT

PRODUCT SUMMARY	
I _{F(AV)}	250 A to 320 A
Type	Modules - Diode, High Voltage
Package	MAGN-A-PAK
Circuit	Two diodes doubler circuit

DESCRIPTION

This new VS-VSK series of MAGN-A-PAKs uses high voltage power diodes in two basic configurations. The semiconductors are electrically isolated from the metal base, allowing common heatsinks and compact assemblies to be built. They can be interconnected to form single phase or three phase bridges and the single diode module can be used in conjunction with the thyristor modules as a freewheel diode. These modules are intended for general purpose applications such as battery chargers, welders and plating equipment and where high voltage and high current are required (motor drives, etc.).

MAJOR RATINGS AND CHARACTERISTICS					
SYMBOL	CHARACTERISTICS	VSK.250..	VSK.270..	VSK.320..	UNITS
I _{F(AV)}		250	270	320	A
	T _C	100	100	100	°C
I _{F(RMS)}		393	424	502	A
I _{FSM}	50 Hz	7015	8920	10 110	
	60 Hz	7345	9430	10 580	
I ² t	50 Hz	246	398	511	kA ² s
	60 Hz	225	363	466	
I ² √t		2460	3980	5110	kA ² √s
V _{RRM}		400 to 3000			V
T _J		-40 to +150			°C



ELECTRICAL SPECIFICATIONS

VOLTAGE RATINGS				
TYPE NUMBER	VOLTAGE CODE	V _{RRM} , MAXIMUM REPETITIVE PEAK REVERSE VOLTAGE V	V _{RSM} , MAXIMUM NON-REPETITIVE PEAK REVERSE VOLTAGE V	I _{RRM} MAXIMUM AT 150 °C mA
VS-VSK.250 VS-VSK.270 VS-VSK.320	04	400	500	50
	08	800	900	
	12	1200	1300	
	16	1600	1700	
	20	2000	2100	
VS-VSK.270	30	3000	3100	

FORWARD CONDUCTION								
PARAMETER	SYMBOL	TEST CONDITIONS		VSK.250	VSK.270	VSK.320	UNITS	
Maximum average forward current at case temperature	I _{F(AV)}	180° conduction, half sine wave		250	270	320	A	
				100	100	100	°C	
Maximum RMS forward current	I _{F(RMS)}	As AC switch		393	424	502		
Maximum peak, one-cycle forward, non-repetitive surge current	I _{FSM}	t = 10 ms	No voltage reappplied	Sinusoidal half wave, initial T _J = T _J maximum	7015	8920	10 110	A
		t = 8.3 ms			7345	9340	10 580	
		t = 10 ms	100 % V _{RRM} reappplied		5900	7500	8500	
		t = 8.3 ms			6180	7850	8900	
Maximum I ² t for fusing	I ² t	t = 10 ms	No voltage reappplied		246	398	511	kA ² s
		t = 8.3 ms			225	363	466	
		t = 10 ms	100 % V _{RRM} reappplied		174	281	361	
		t = 8.3 ms			159	257	330	
Maximum I ² √t for fusing	I ² √t	t = 0.1 ms to 10 ms, no voltage reappplied		2460	3980	5110	kA ² /s	
Low level value of threshold voltage	V _{F(TO)1}	(16.7 % × π × I _{F(AV)} < I < π × I _{F(AV)}), T _J = T _J maximum		0.79	0.74	0.69	V	
High level value of threshold voltage	V _{F(TO)2}	(I > π × I _{F(AV)}), T _J = T _J maximum		0.92	0.87	0.86		
Low level forward slope resistance	r _{f1}	(16.7 % × π × I _{F(AV)} < I < π × I _{F(AV)}), T _J = T _J maximum		0.63	0.94	0.59	mΩ	
High level forward slope resistance	r _{f2}	(I > π × I _{F(AV)}), T _J = T _J maximum		0.49	0.81	0.44		
Maximum forward voltage drop	V _{FM}	I _{FM} = π × I _{F(AV)} , T _J = T _J maximum, 180° conduction Average power = V _{F(TO)} × I _{F(AV)} + r _f × (I _{F(RMS)}) ²		1.29	1.48	1.28	V	

BLOCKING				
PARAMETER	SYMBOL	TEST CONDITIONS	VALUES	UNITS
Maximum peak reverse leakage current	I _{RRM}	T _J = 150 °C	50	mA
RMS insulation voltage	V _{INS}	50 Hz, circuit to base, all terminals shorted, t = 1 s	3000	V



THERMAL AND MECHANICAL SPECIFICATIONS						
PARAMETER	SYMBOL	TEST CONDITIONS	VALUES			UNITS
			VSK.250	VSK.270	VSK.320	
Maximum junction operating and storage temperature range	T_J, T_{Stg}		-40 to +150			°C
Maximum thermal resistance, junction to case per junction	R_{thJC}	DC operation	0.16	0.125		K/W
Maximum resistance, case to heatsink per module	R_{thCS}	Mounting surface flat, smooth and greased	0.035			
Mounting torque ± 10 %	MAP to heatsink	A mounting compound is recommended and the torque should be rechecked after a period of about 3 hours to allow for the spread of the compound.	4 to 6			Nm
	busbar to MAP		8 to 10			
Approximate weight			800			g
			30			oz.
Case style			MAGN-A-PAK			

ΔR CONDUCTION PER JUNCTION											
DEVICE	SINUSOIDAL CONDUCTION AT T_J MAXIMUM					RECTANGULAR CONDUCTION AT T_J MAXIMUM					UNITS
	180°	120°	90°	60°	30°	180°	120°	90°	60°	30°	
VSK.250	0.009	0.010	0.014	0.020	0.032	0.007	0.011	0.015	0.021	0.033	K/W
VSK.270	0.008	0.012	0.014	0.020	0.032	0.007	0.011	0.015	0.020	0.033	
VSK.320	0.008	0.010	0.013	0.020	0.032	0.007	0.011	0.015	0.020	0.033	

Note

- The table above shows the increment of thermal resistance R_{thJC} when devices operate at different conduction angles than DC



VS-VSK.250PbF, VS-VSK.270PbF, VS-VSK.320PbF Series

www.vishay.com

Vishay Semiconductors

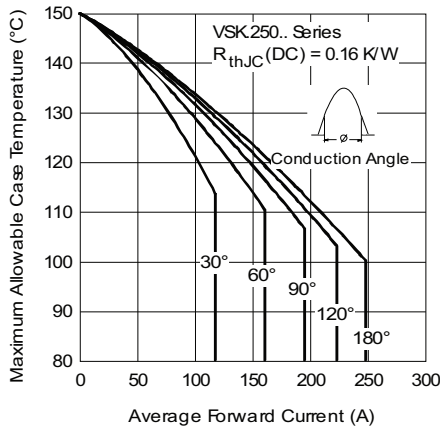

Fig. 1 - Current Ratings Characteristics

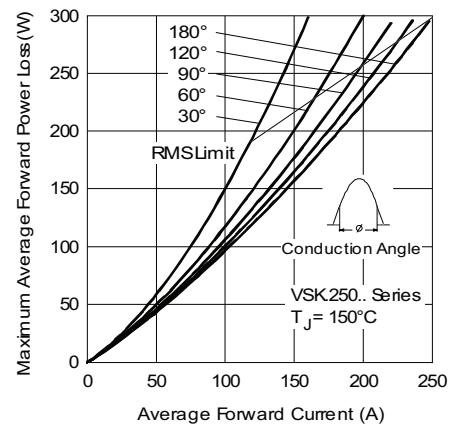

Fig. 3 - Forward Power Loss Characteristics

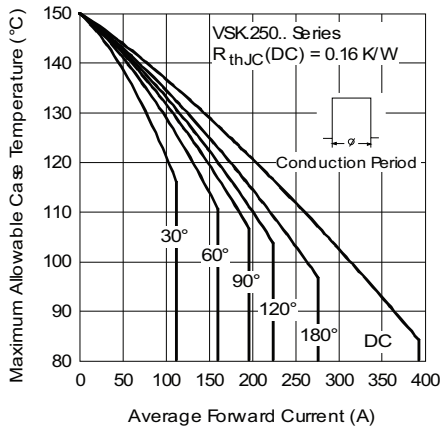

Fig. 2 - Current Ratings Characteristics

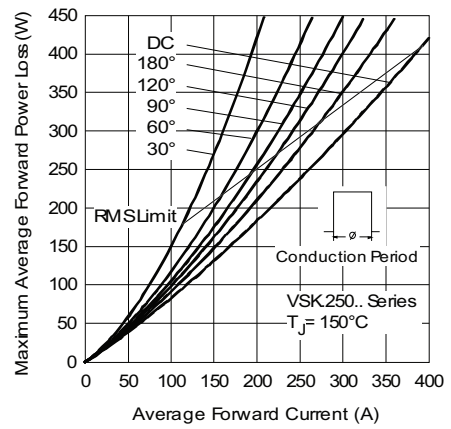

Fig. 4 - Forward Power Loss Characteristics

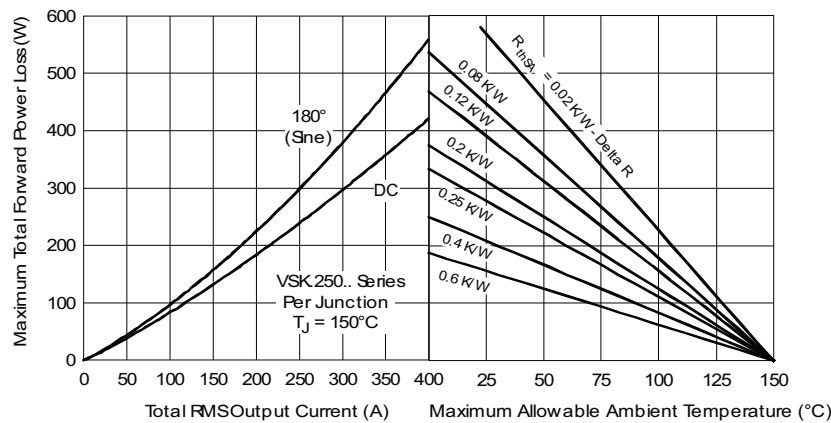

Fig. 5 - Forward Power Loss Characteristics

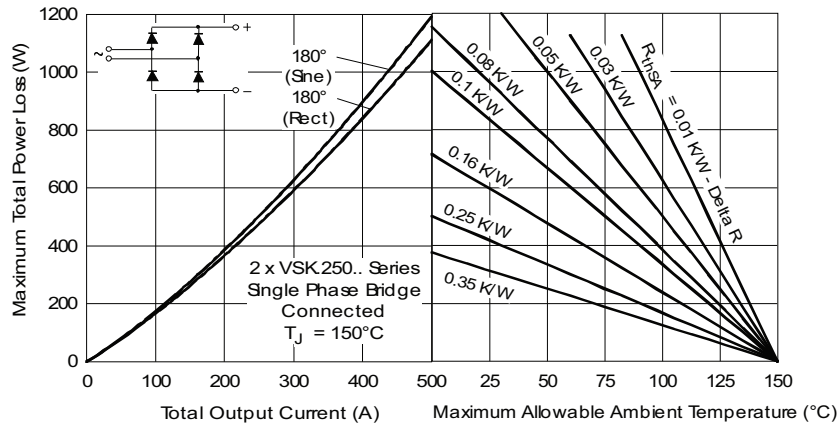

Fig. 6 - Forward Power Loss Characteristics

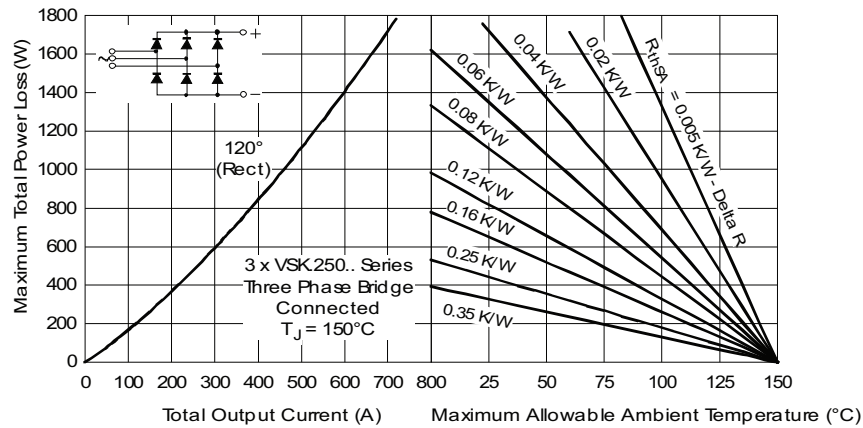

Fig. 7 - Forward Power Loss Characteristics

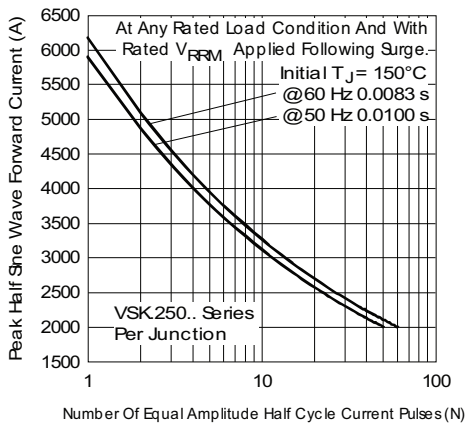

Fig. 8 - Maximum Non-Repetitive Surge Current

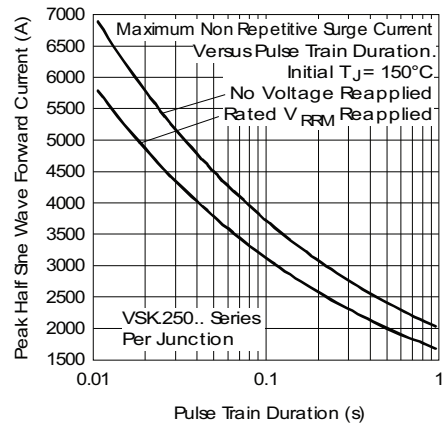

Fig. 9 - Maximum Non-Repetitive Surge Current

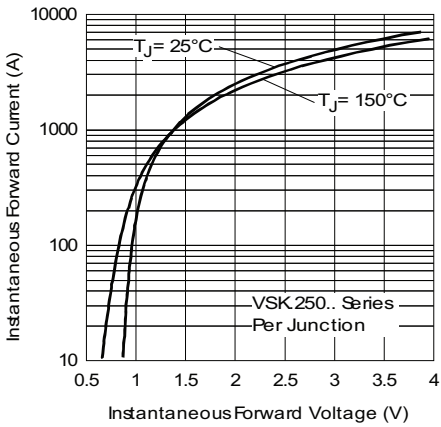

Fig. 10 - Forward Voltage Drop Characteristics

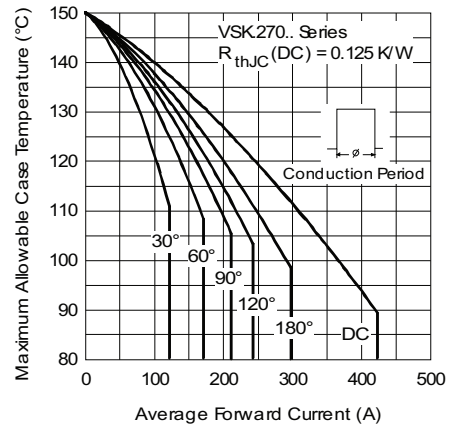

Fig. 13 - Current Ratings Characteristics

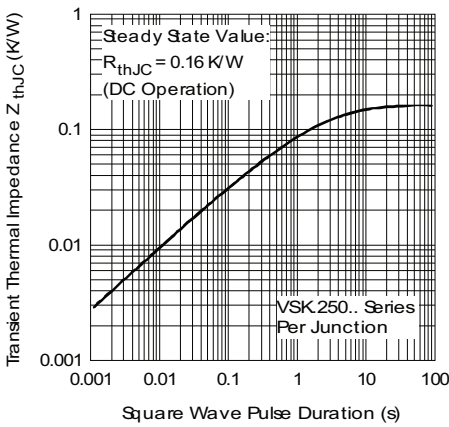

Fig. 11 - Thermal Impedance Z_{thJC} Characteristics

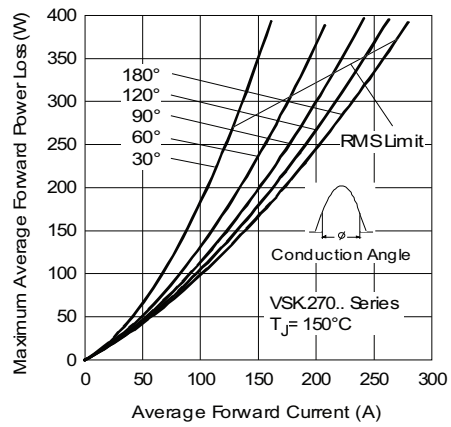

Fig. 14 - Forward Power Loss Characteristics

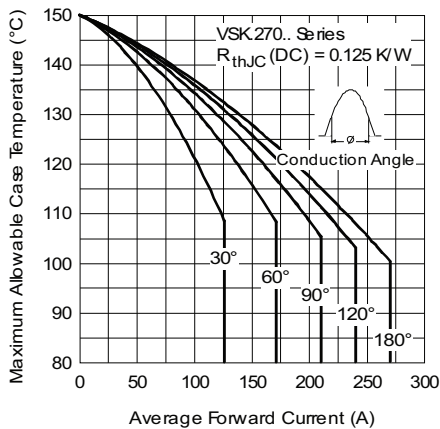

Fig. 12 - Current Ratings Characteristics

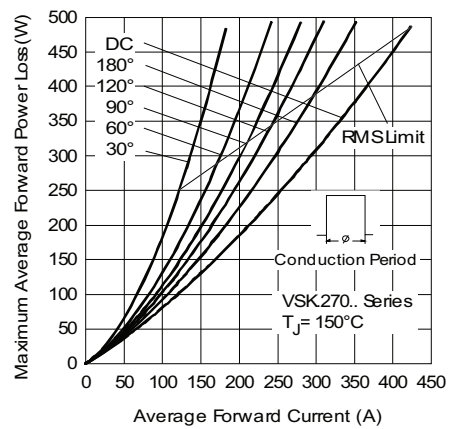

Fig. 15 - Forward Power Loss Characteristics

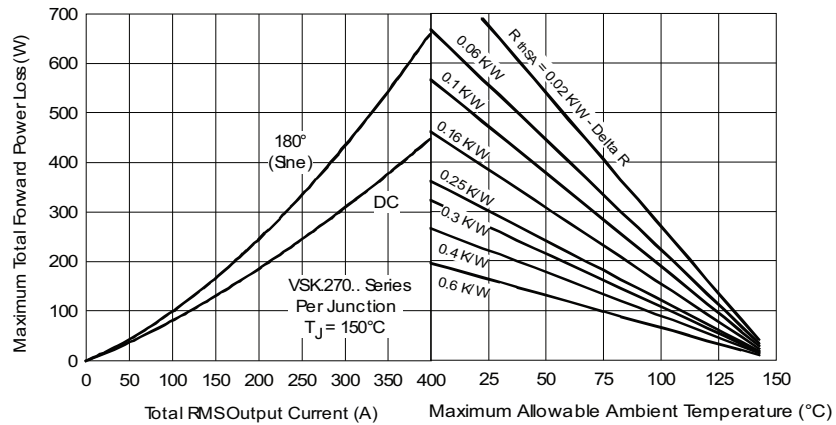

Fig. 16 - Forward Power Loss Characteristics

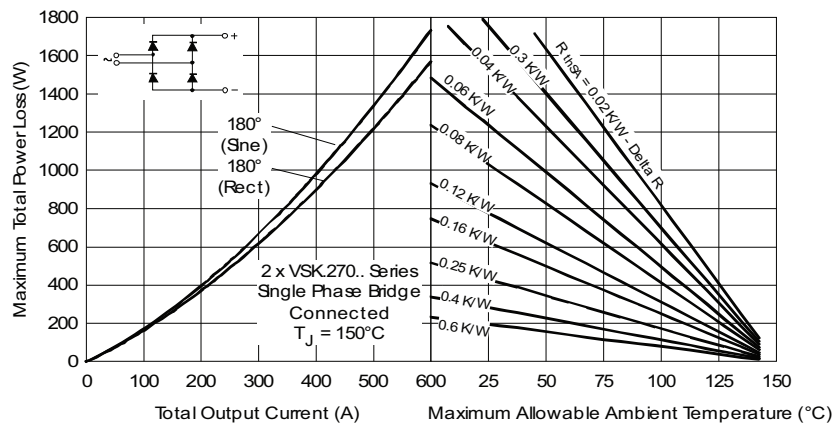

Fig. 17 - Forward Power Loss Characteristics

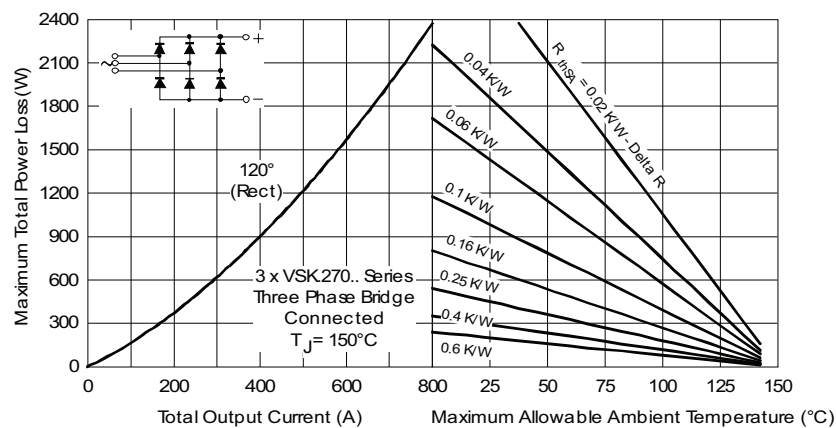

Fig. 18 - Forward Power Loss Characteristics

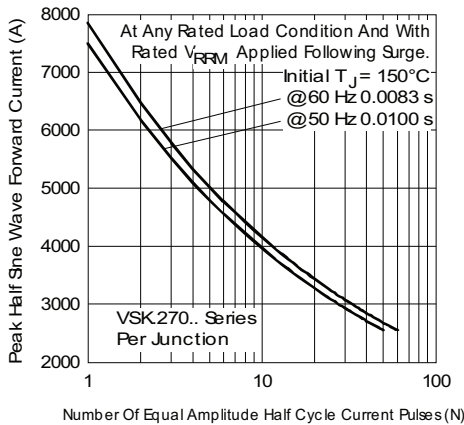

Fig. 19 - Maximum Non-Repetitive Surge Current

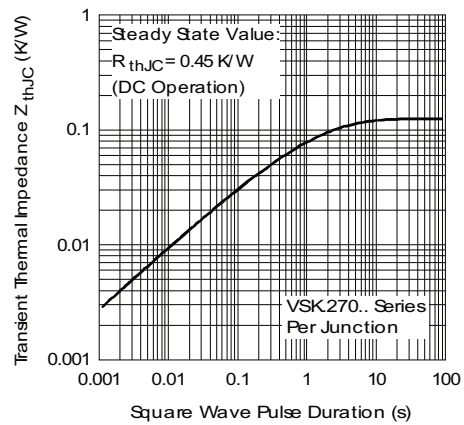

Fig. 22 - Thermal Impedance Z_{thJC} Characteristics

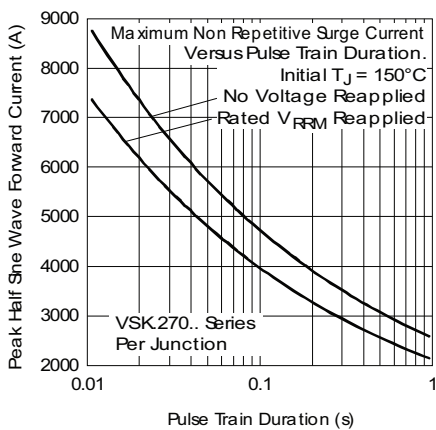

Fig. 20 - Maximum Non-Repetitive Surge Current

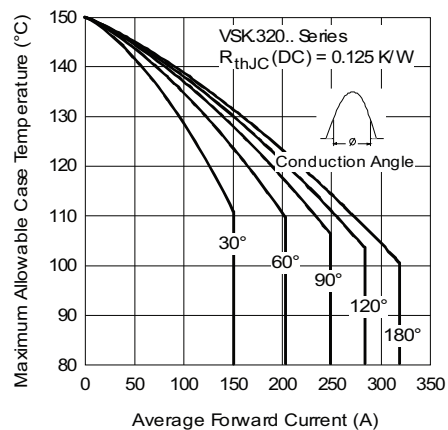

Fig. 23 - Current Ratings Characteristics

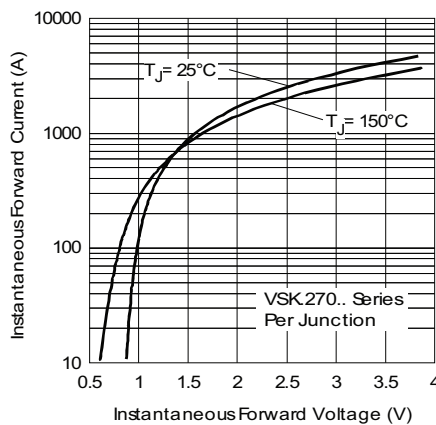

Fig. 21 - Forward Voltage Drop Characteristics

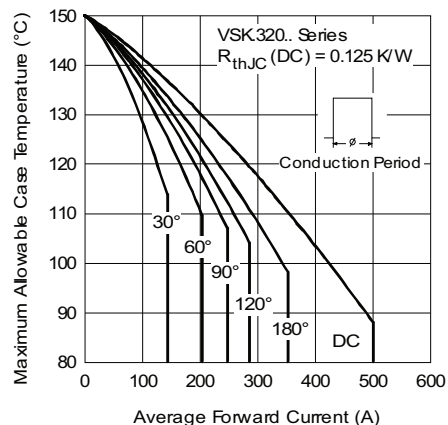

Fig. 24 - Current Ratings Characteristics



VS-VSK.250PbF, VS-VSK.270PbF, VS-VSK.320PbF Series

www.vishay.com

Vishay Semiconductors

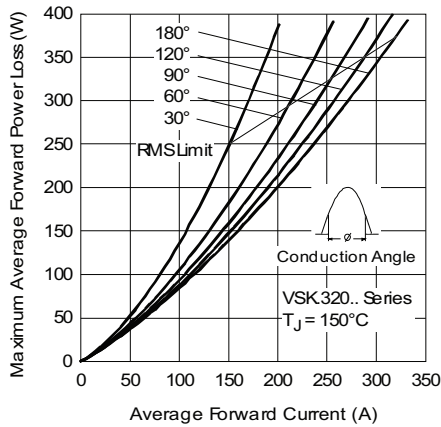

Fig. 25 - Forward Power Loss Characteristics

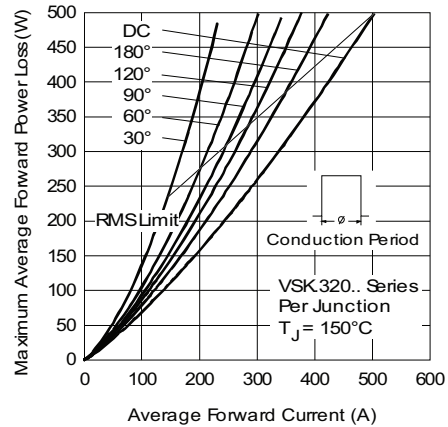

Fig. 26 - Forward Power Loss Characteristics

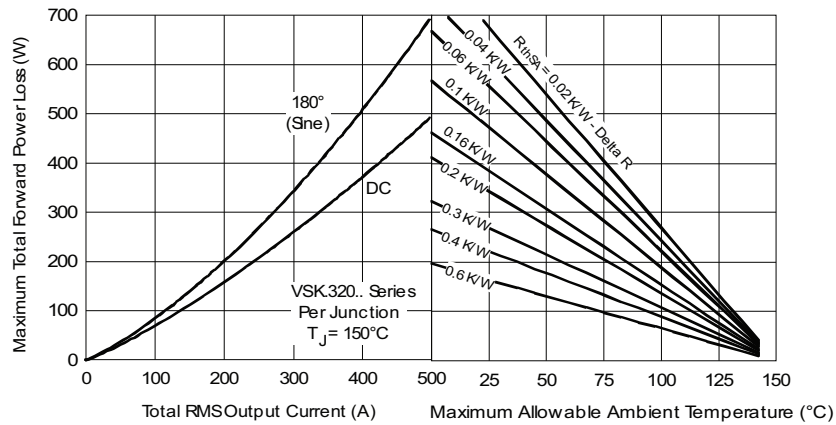

Fig. 27 - Forward Power Loss Characteristics

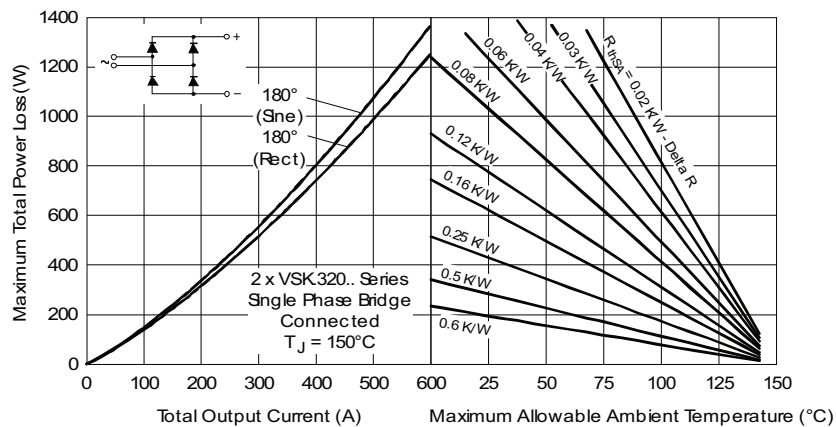

Fig. 28 - Forward Power Loss Characteristics

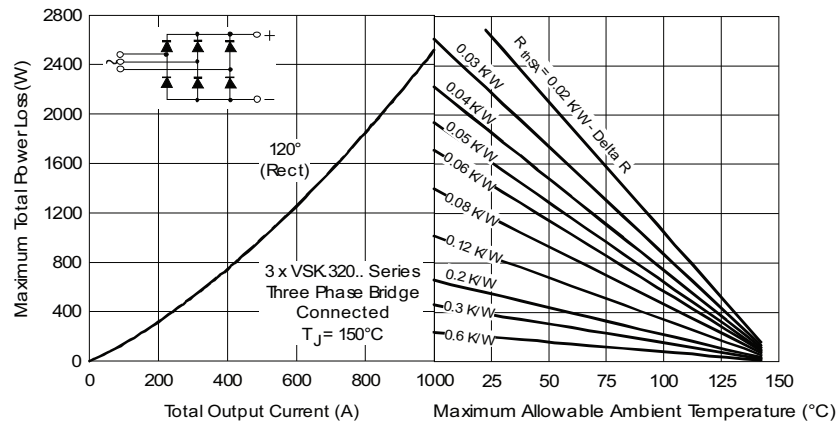

Fig. 29 - Forward Power Loss Characteristics

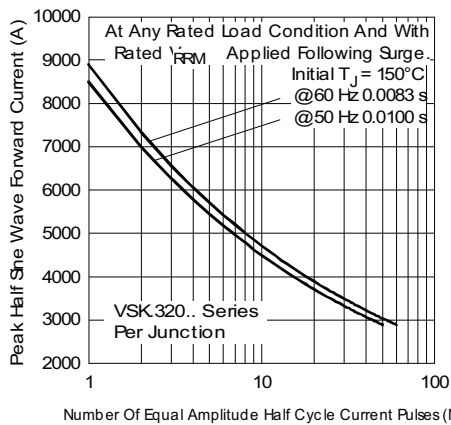

Fig. 30 - Maximum Non-Repetitive Surge Current

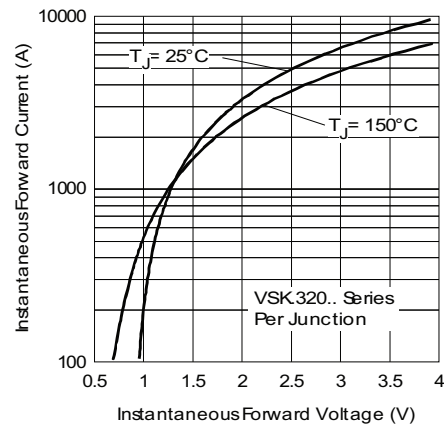

Fig. 32 - Forward Voltage Drop Characteristics

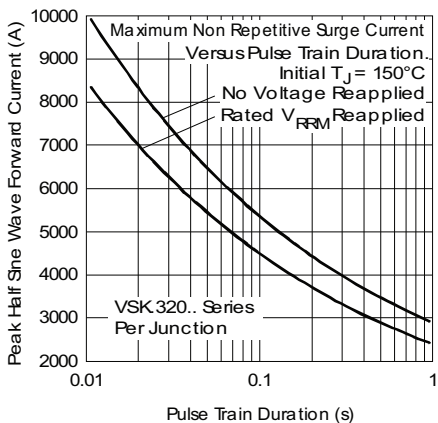

Fig. 31 - Maximum Non-Repetitive Surge Current

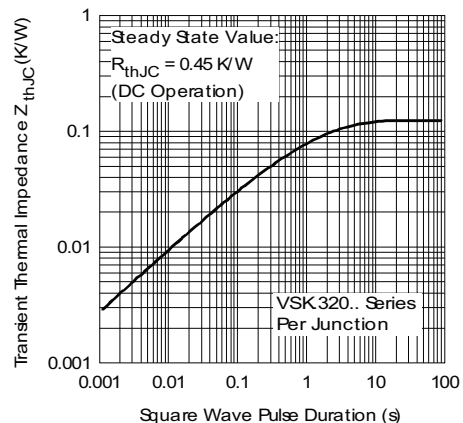

Fig. 33 - Thermal Impedance Z_{thJC} Characteristics



ORDERING INFORMATION TABLE

Device code	VS-VS	KD	320	-	24	PbF
	①	②	③		④	⑤
	1	2	3	4	5	
	-	-	-	-	-	
	Vishay Semiconductors product	Circuit configuration (see Circuit Configuration table)	Current rating: $I_{F(AV)}$ rounded	Voltage code x 100 = V_{RRM} (see Voltage Ratings table)	Lead (Pb)-free	

CIRCUIT CONFIGURATION		
CIRCUIT DESCRIPTION	CIRCUIT CONFIGURATION CODE	CIRCUIT DRAWING
Two diodes doubler circuit	KD	<p style="text-align: center;">VSKD...</p>
Two diodes common cathodes	KC	<p style="text-align: center;">VSKC...</p>
Two diodes common anodes	KJ	<p style="text-align: center;">VSKJ...</p>
Single diode	KE	<p style="text-align: center;">VSKE...</p>

LINKS TO RELATED DOCUMENTS	
Dimensions	www.vishay.com/doc?95086

MAGN-A-PAK

DIMENSIONS in millimeters (inches)

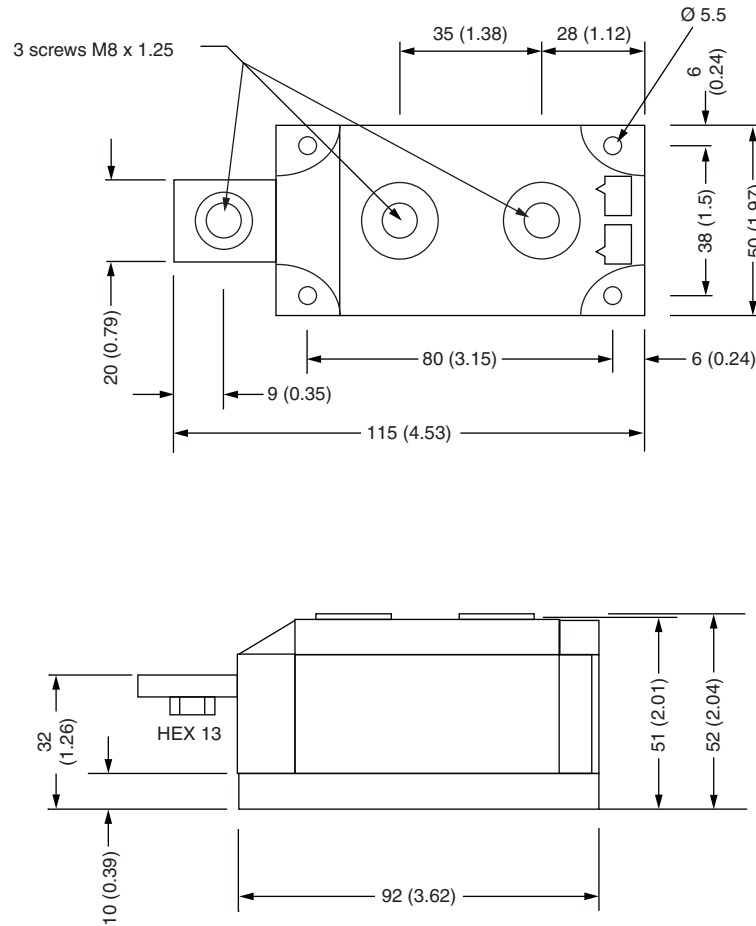

Notes

- Dimensions are nominal
- Full engineering drawings are available on request
- UL identification number for gate and cathode wire: UL 1385
- UL identification number for package: UL 94 V-0



Disclaimer

ALL PRODUCT, PRODUCT SPECIFICATIONS AND DATA ARE SUBJECT TO CHANGE WITHOUT NOTICE TO IMPROVE RELIABILITY, FUNCTION OR DESIGN OR OTHERWISE.

Vishay Intertechnology, Inc., its affiliates, agents, and employees, and all persons acting on its or their behalf (collectively, "Vishay"), disclaim any and all liability for any errors, inaccuracies or incompleteness contained in any datasheet or in any other disclosure relating to any product.

Vishay makes no warranty, representation or guarantee regarding the suitability of the products for any particular purpose or the continuing production of any product. To the maximum extent permitted by applicable law, Vishay disclaims (i) any and all liability arising out of the application or use of any product, (ii) any and all liability, including without limitation special, consequential or incidental damages, and (iii) any and all implied warranties, including warranties of fitness for particular purpose, non-infringement and merchantability.

Statements regarding the suitability of products for certain types of applications are based on Vishay's knowledge of typical requirements that are often placed on Vishay products in generic applications. Such statements are not binding statements about the suitability of products for a particular application. It is the customer's responsibility to validate that a particular product with the properties described in the product specification is suitable for use in a particular application. Parameters provided in datasheets and / or specifications may vary in different applications and performance may vary over time. All operating parameters, including typical parameters, must be validated for each customer application by the customer's technical experts. Product specifications do not expand or otherwise modify Vishay's terms and conditions of purchase, including but not limited to the warranty expressed therein.

Except as expressly indicated in writing, Vishay products are not designed for use in medical, life-saving, or life-sustaining applications or for any other application in which the failure of the Vishay product could result in personal injury or death. Customers using or selling Vishay products not expressly indicated for use in such applications do so at their own risk. Please contact authorized Vishay personnel to obtain written terms and conditions regarding products designed for such applications.

No license, express or implied, by estoppel or otherwise, to any intellectual property rights is granted by this document or by any conduct of Vishay. Product names and markings noted herein may be trademarks of their respective owners.