



Chipsmall Limited consists of a professional team with an average of over 10 year of expertise in the distribution of electronic components. Based in Hongkong, we have already established firm and mutual-benefit business relationships with customers from,Europe,America and south Asia,supplying obsolete and hard-to-find components to meet their specific needs.

With the principle of “Quality Parts,Customers Priority,Honest Operation,and Considerate Service”,our business mainly focus on the distribution of electronic components. Line cards we deal with include Microchip,ALPS,ROHM,Xilinx,Pulse,ON,Everlight and Freescale. Main products comprise IC,Modules,Potentiometer,IC Socket,Relay,Connector.Our parts cover such applications as commercial,industrial, and automotives areas.

We are looking forward to setting up business relationship with you and hope to provide you with the best service and solution. Let us make a better world for our industry!



Contact us

Tel: +86-755-8981 8866 Fax: +86-755-8427 6832

Email & Skype: info@chipsmall.com Web: www.chipsmall.com

Address: A1208, Overseas Decoration Building, #122 Zhenhua RD., Futian, Shenzhen, China



Standard Rectifier Module

3~ Rectifier	
V_{RRM}	= 1200 V
I_{DAV}	= 60 A
I_{FSM}	= 750 A

3~ Rectifier Bridge

Part number

VUO55-12N07

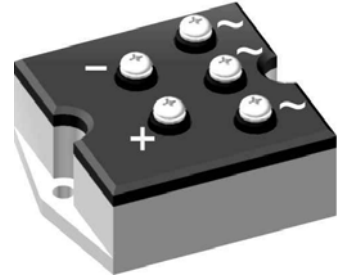

 E72873

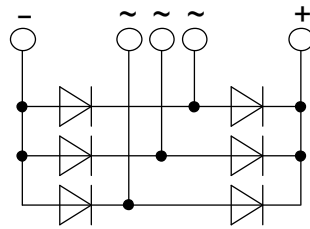

Features / Advantages:

- Package with DCB ceramic
- Improved temperature and power cycling
- Planar passivated chips
- Very low forward voltage drop
- Very low leakage current

Applications:

- Diode for main rectification
- For three phase bridge configurations
- Supplies for DC power equipment
- Input rectifiers for PWM inverter
- Battery DC power supplies
- Field supply for DC motors

Package: PWS-B

- Industry standard outline
- RoHS compliant
- Easy to mount with two screws
- Base plate: Aluminium internally DCB isolated
- Advanced power cycling

Rectifier				Ratings				
Symbol	Definition	Conditions		min.	typ.	max.	Unit	
V_{RSM}	max. non-repetitive reverse blocking voltage					1300	V	
V_{RRM}	max. repetitive reverse blocking voltage					1200	V	
I_R	reverse current	$V_R = 1200$ V	$T_{VJ} = 25^\circ\text{C}$			100	μA	
		$V_R = 1200$ V	$T_{VJ} = 150^\circ\text{C}$			1.5	mA	
V_F	forward voltage drop	$I_F = 20$ A	$T_{VJ} = 25^\circ\text{C}$			1.03	V	
		$I_F = 60$ A				1.23	V	
		$I_F = 20$ A	$T_{VJ} = 125^\circ\text{C}$			0.92	V	
		$I_F = 60$ A				1.18	V	
I_{DAV}	bridge output current	$T_C = 85^\circ\text{C}$	$T_{VJ} = 150^\circ\text{C}$			60	A	
		rectangular	$d = \frac{1}{3}$					
V_{FO}	threshold voltage	} for power loss calculation only				0.76	V	
r_F	slope resistance						6.9	m Ω
R_{thJC}	thermal resistance junction to case					2.7	K/W	
R_{thCH}	thermal resistance case to heatsink			0.4			K/W	
P_{tot}	total power dissipation			$T_C = 25^\circ\text{C}$			46	W
I_{FSM}	max. forward surge current	$t = 10$ ms; (50 Hz), sine	$T_{VJ} = 45^\circ\text{C}$			750	A	
		$t = 8,3$ ms; (60 Hz), sine	$V_R = 0$ V			810	A	
		$t = 10$ ms; (50 Hz), sine	$T_{VJ} = 150^\circ\text{C}$			640	A	
		$t = 8,3$ ms; (60 Hz), sine	$V_R = 0$ V			690	A	
I^2t	value for fusing	$t = 10$ ms; (50 Hz), sine	$T_{VJ} = 45^\circ\text{C}$			2.82	kA ² s	
		$t = 8,3$ ms; (60 Hz), sine	$V_R = 0$ V			2.73	kA ² s	
		$t = 10$ ms; (50 Hz), sine	$T_{VJ} = 150^\circ\text{C}$			2.05	kA ² s	
		$t = 8,3$ ms; (60 Hz), sine	$V_R = 0$ V			1.98	kA ² s	
C_J	junction capacitance	$V_R = 400$ V; $f = 1$ MHz		$T_{VJ} = 25^\circ\text{C}$		10	pF	

Package PWS-B			Ratings			
Symbol	Definition	Conditions	min.	typ.	max.	Unit
I_{RMS}	RMS current	per terminal			100	A
T_{stg}	storage temperature		-40		125	°C
T_{VJ}	virtual junction temperature		-40		150	°C
Weight				203		g
M_D	mounting torque		4.25		5.75	Nm
M_T	terminal torque		2.5		3.5	Nm
$d_{Spp/App}$	creepage distance on surface striking distance through air	terminal to terminal	11.0			mm
$d_{Spb/Appb}$		terminal to backside	7.5			mm
V_{ISOL}	isolation voltage	t = 1 second	3000			V
		t = 1 minute	2500			V

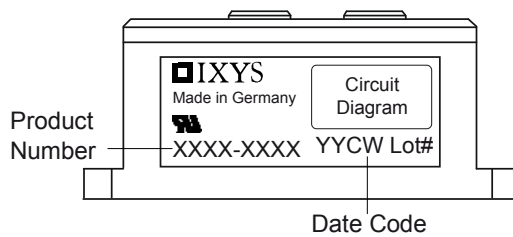

Ordering	Part Number	Marking on Product	Delivery Mode	Quantity	Code No.
Standard	VUO55-12NO7	VUO55-12NO7	Box	10	456675

Equivalent Circuits for Simulation

* on die level

$T_{VJ} = 150\text{ °C}$

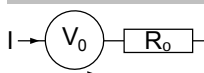

Rectifier

$V_{0\ max}$	threshold voltage	0.76	V
$R_{0\ max}$	slope resistance *	5.7	mΩ

Outlines PWS-B

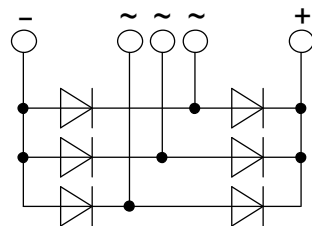
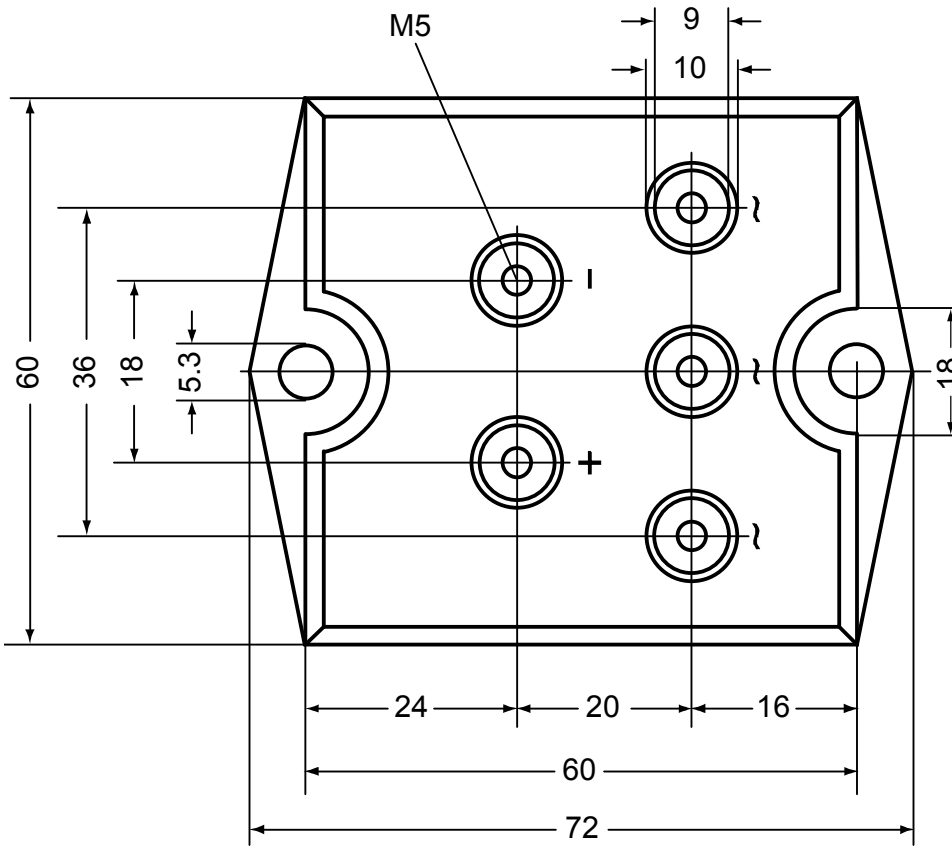
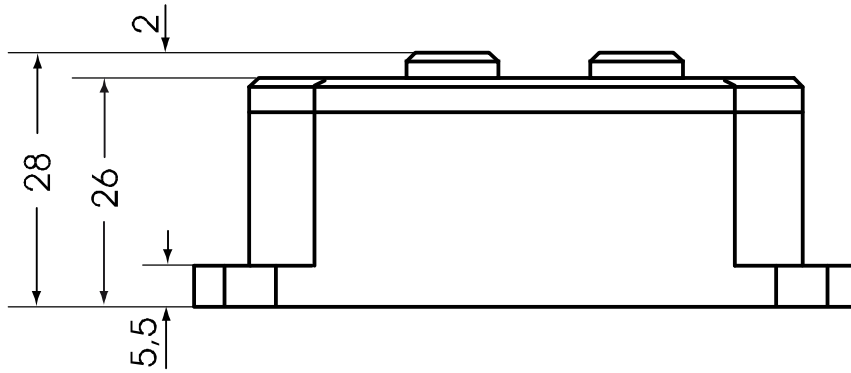

Rectifier

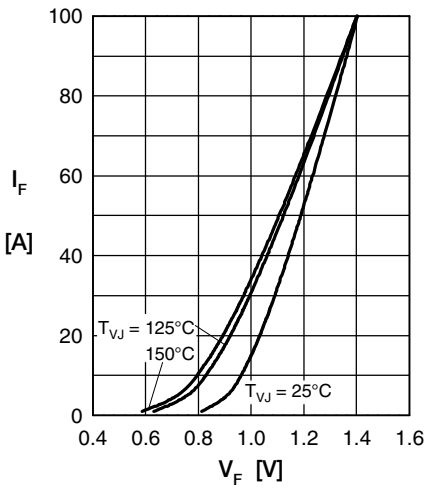

Fig. 1 Forward current vs. voltage drop per diode

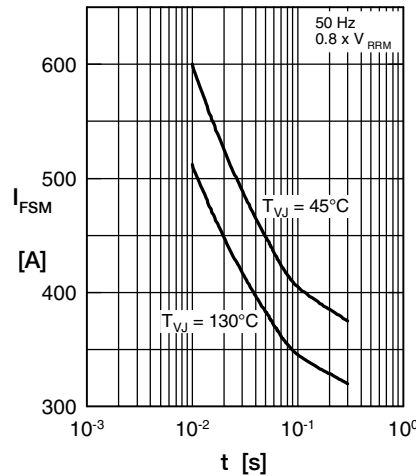

Fig. 2 Surge overload current vs. time per diode

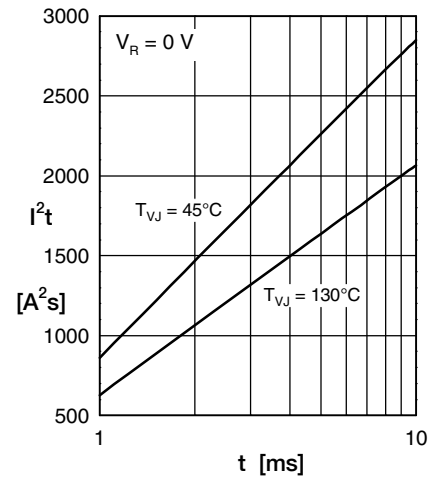

Fig. 3 I^2t vs. time per diode

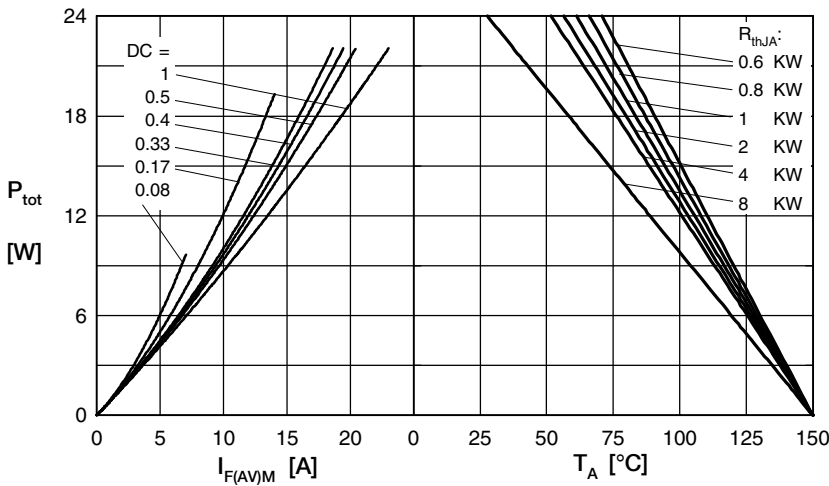

Fig. 4 Power dissipation vs. forward current and ambient temperature per diode

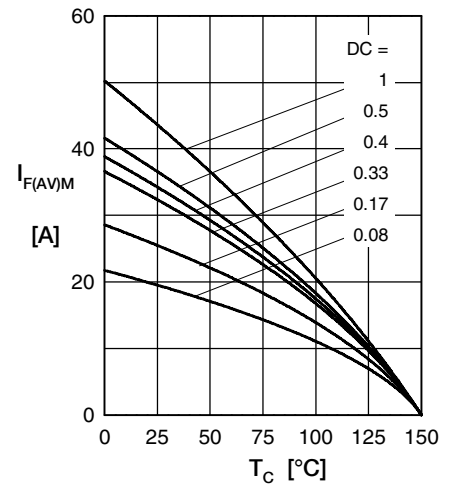

Fig. 5 Max. forward current vs. case temperature per diode

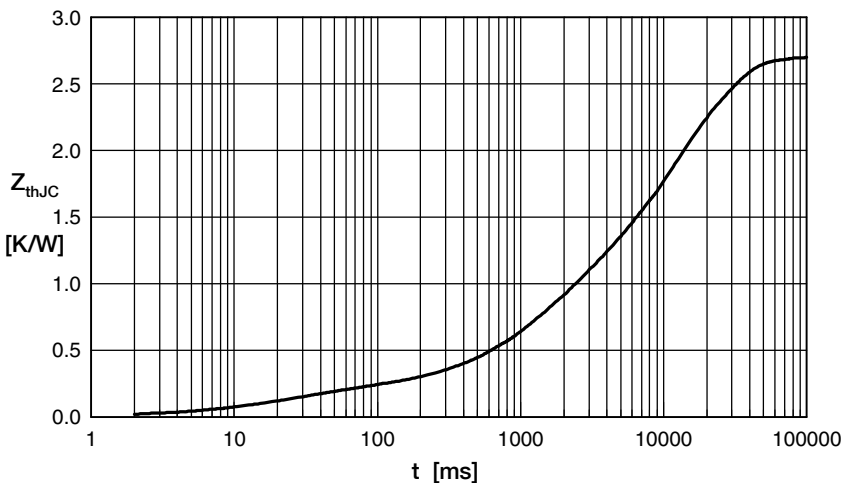

Fig. 6 Transient thermal impedance junction to case vs. time per diode

Constants for Z_{thJC} calculation:

i	R_{th} (K/W)	t_i (s)
1	0.040	0.010
2	0.150	0.030
3	0.610	1.350
4	1.900	14.00