



Chipsmall Limited consists of a professional team with an average of over 10 year of expertise in the distribution of electronic components. Based in Hongkong, we have already established firm and mutual-benefit business relationships with customers from,Europe,America and south Asia,supplying obsolete and hard-to-find components to meet their specific needs.

With the principle of “Quality Parts,Customers Priority,Honest Operation,and Considerate Service”,our business mainly focus on the distribution of electronic components. Line cards we deal with include Microchip,ALPS,ROHM,Xilinx,Pulse,ON,Everlight and Freescale. Main products comprise IC,Modules,Potentiometer,IC Socket,Relay,Connector.Our parts cover such applications as commercial,industrial, and automotives areas.

We are looking forward to setting up business relationship with you and hope to provide you with the best service and solution. Let us make a better world for our industry!



## Contact us

Tel: +86-755-8981 8866 Fax: +86-755-8427 6832

Email & Skype: info@chipsmall.com Web: www.chipsmall.com

Address: A1208, Overseas Decoration Building, #122 Zhenhua RD., Futian, Shenzhen, China



# Three Phase Half Controlled Rectifier Bridge, B6HK

$$I_{dAVM} = 110/167 \text{ A}$$

$$V_{RRM} = 1200-1600 \text{ V}$$

$V_{RSM}$ $V_{DSM}$ V	$V_{RRM}$ $V_{DRM}$ V	Type
1300 1700	1200 1600	VVZ 110-12io7 VVZ 175-12io7 VVZ 175-16io7

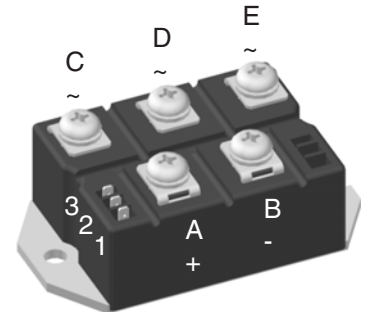
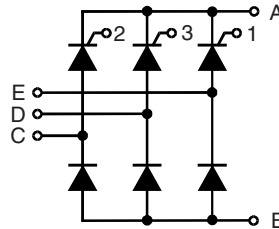

Symbol	Test Conditions	Maximum Ratings		
		VVZ 110	VVZ 175	
$I_{dAV}$ $I_{FRMS}, I_{TRMS}$	$T_C = 85^\circ\text{C}$ ; module per leg	110 58	167 89	A A
$I_{FSM}, I_{TSM}$	$T_{VJ} = 45^\circ\text{C}$ ; $V_R = 0$ $t = 10 \text{ ms (50 Hz), sine}$ $t = 8.3 \text{ ms (60 Hz), sine}$	1150 1230	1500 1600	A A
	$T_{VJ} = T_{VJM}$ ; $V_R = 0$ $t = 10 \text{ ms (50 Hz), sine}$ $t = 8.3 \text{ ms (60 Hz), sine}$	1000 1070	1350 1450	A A
$I^2t$	$T_{VJ} = 45^\circ\text{C}$ ; $V_R = 0$ $t = 10 \text{ ms (50 Hz), sine}$ $t = 8.3 \text{ ms (60 Hz), sine}$	6600 6280	11200 10750	$\text{A}^2\text{s}$ $\text{A}^2\text{s}$
	$T_{VJ} = T_{VJM}$ ; $V_R = 0$ $t = 10 \text{ ms (50 Hz), sine}$ $t = 8.3 \text{ ms (60 Hz), sine}$	5000 4750	9100 8830	$\text{A}^2\text{s}$ $\text{A}^2\text{s}$
$(di/dt)_{cr}$	$T_{VJ} = T_{VJM}$ repetitive, $I_T = 50 \text{ A}$ $f = 400 \text{ Hz}$ , $t_p = 200 \mu\text{s}$ $V_D = 2/3 V_{DRM}$ $I_G = 0.3 \text{ A}$ , non repetitive, $di_G/dt = 0.3 \text{ A}/\mu\text{s}$ , $I_T = 1/3 \cdot I_{dAV}$	150	500	$\text{A}/\mu\text{s}$ $\text{A}/\mu\text{s}$
$(dv/dt)_{cr}$	$T_{VJ} = T_{VJM}$ ; $V_{DR} = 2/3 V_{DRM}$ $R_{GK} = \infty$ ; method 1 (linear voltage rise)	1000		$\text{V}/\mu\text{s}$
$V_{RGM}$		10		V
$P_{GM}$	$T_{VJ} = T_{VJM}$ $I_T = I_{TAVM}$	$t_p = 30 \mu\text{s}$ $t_p = 500 \mu\text{s}$ $t_p = 10 \text{ ms}$	$\leq 10$ $\leq 5$ $\leq 1$	W W W
$P_{GAVM}$			0.5	W
$T_{VJ}$		-40...+125		$^\circ\text{C}$
$T_{VJM}$		125		$^\circ\text{C}$
$T_{stg}$		-40...+125		$^\circ\text{C}$
$V_{ISOL}$	50/60 Hz, RMS $t = 1 \text{ min}$ $I_{ISOL} \leq 1 \text{ mA}$ $t = 1 \text{ s}$	2500 3000		V~ V~
$M_d$	Mounting torque (M6) Terminal connection torque (M6)	5±15 % 5±15 %		Nm Nm
Weight	typ.	300		g

Data according to IEC 60747 and refer to a single thyristor/diode unless otherwise stated.

IXYS reserves the right to change limits, test conditions and dimensions.

20100706b

## Features

- Package with screw terminals
- Isolation voltage 3000 V~
- Planar passivated chips
- UL registered E72873

## Applications

- Input rectifier for PWM converter
- Input rectifier for switch mode power supplies (SMPS)
- Softstart capacitor charging

## Advantages

- Easy to mount with two screws
- Space and weight savings
- Improved temperature and power cycling

Symbol	Test Conditions	Characteristic Values		
		VVZ 110	VVZ 175	
$I_R, I_D$	$V_R = V_{RRM}; V_D = V_{DRM}$	$T_{VJ} = T_{VJM}$ $T_{VJ} = 25^\circ\text{C}$	$\leq 5$	mA
			$\leq 0.3$	mA
$V_F, V_T$	$I_F, I_T = 200 \text{ A}, T_{VJ} = 25^\circ\text{C}$	$\leq 1.75$	1.57	V
$V_{T0}$	For power-loss calculations only	0.85	0.85	V
$r_T$	( $T_{VJ} = 125^\circ\text{C}$ )	6	3.5	m $\Omega$
$V_{GT}$	$V_D = 6 \text{ V};$	$T_{VJ} = 25^\circ\text{C}$	$\leq 1.5$	V
		$T_{VJ} = -40^\circ\text{C}$	$\leq 1.6$	V
$I_{GT}$	$V_D = 6 \text{ V};$	$T_{VJ} = 25^\circ\text{C}$	$\leq 100$	mA
		$T_{VJ} = -40^\circ\text{C}$	$\leq 200$	mA
$V_{GD}$	$T_{VJ} = T_{VJM}; V_D = \frac{2}{3} V_{DRM}$	$\leq 0.2$	0.2	V
$I_{GD}$	$T_{VJ} = T_{VJM}; V_D = \frac{2}{3} V_{DRM}$	$\leq 5$	5	mA
$I_L$	$I_G = 0.3 \text{ A}; t_G = 30 \mu\text{s}$ $di_G/dt = 0.3 \text{ A}/\mu\text{s}$	$T_{VJ} = 25^\circ\text{C}$	$\leq 450$	mA
$I_H$	$T_{VJ} = 25^\circ\text{C}; V_D = 6 \text{ V}; R_{GK} = \infty$	$\leq 200$	200	mA
$t_{gd}$	$T_{VJ} = 25^\circ\text{C}; V_D = \frac{1}{2} V_{DRM}$ $I_G = 0.3 \text{ A}; di_G/dt = 0.3 \text{ A}/\mu\text{s}$	$\leq 2$	2	$\mu\text{s}$
$R_{thJC}$	per thyristor (diode); DC current per module	0.65	0.46	K/W
		0.108	0.077	K/W
$R_{thJH}$	per thyristor (diode); DC current per module	0.8	0.55	K/W
		0.133	0.092	K/W
$d_s$	Creeping distance on surface	10	10	mm
$d_A$	Creepage distance in air	9.4	9.4	mm
$a$	Max. allowable acceleration	50	50	m/s <sup>2</sup>

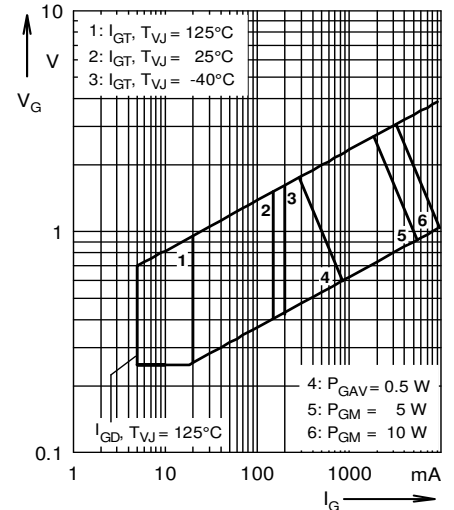

Fig. 1 Gate trigger characteristics

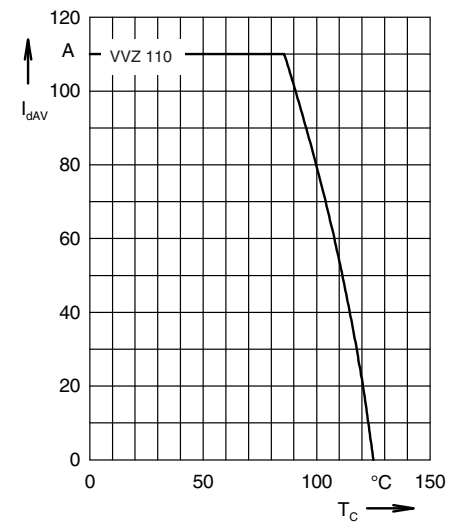

Fig. 2 DC output current at case temperature

Dimensions in mm (1 mm = 0.0394")

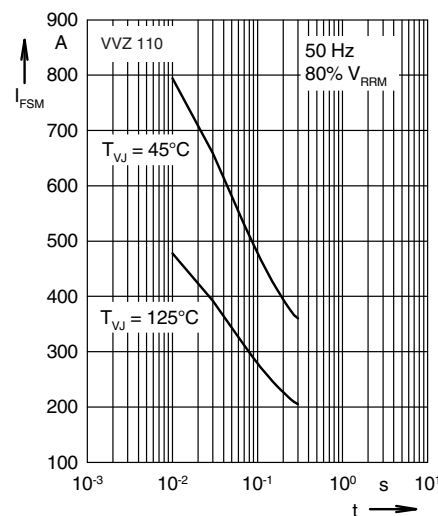
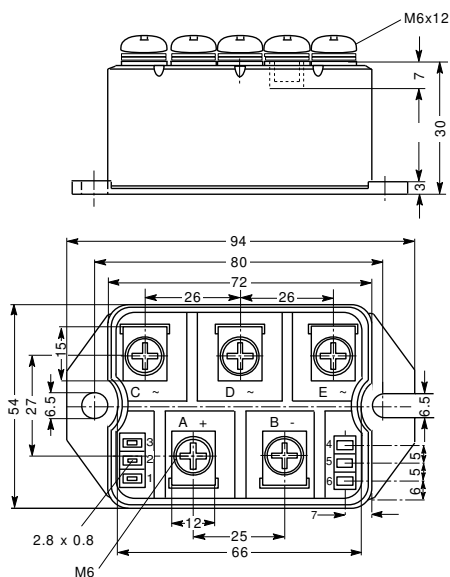

Fig. 3 Surge overload current  
 $I_{FSM}$ : Crest value, t: duration

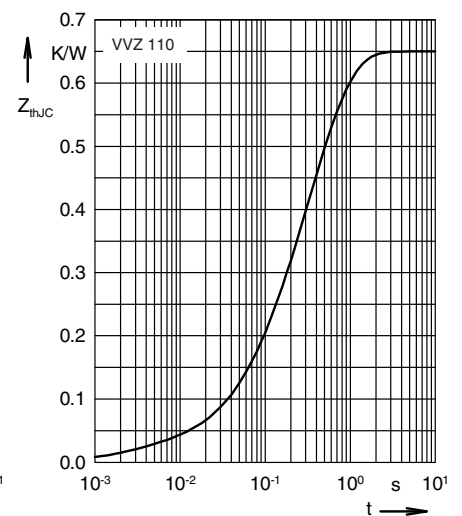

Fig. 4 Transient thermal impedance junction to case (per leg)