



Chipsmall Limited consists of a professional team with an average of over 10 year of expertise in the distribution of electronic components. Based in Hongkong, we have already established firm and mutual-benefit business relationships with customers from,Europe,America and south Asia,supplying obsolete and hard-to-find components to meet their specific needs.

With the principle of "Quality Parts,Customers Priority,Honest Operation,and Considerate Service",our business mainly focus on the distribution of electronic components. Line cards we deal with include Microchip,ALPS,ROHM,Xilinx,Pulse,ON,Everlight and Freescale. Main products comprise IC,Modules,Potentiometer,IC Socket,Relay,Connector.Our parts cover such applications as commercial,industrial, and automotives areas.

We are looking forward to setting up business relationship with you and hope to provide you with the best service and solution. Let us make a better world for our industry!



## Contact us

Tel: +86-755-8981 8866 Fax: +86-755-8427 6832

Email & Skype: info@chipsmall.com Web: www.chipsmall.com

Address: A1208, Overseas Decoration Building, #122 Zhenhua RD., Futian, Shenzhen, China





# 产品规格书

PRODUCT SPECIFICATION

客户名称Buyer Name	
客户料号Buyer Part No.	
客户承认签章 Buyers Approval & Signatures	

文件编号Spec No.	JYW0625A20B01	版本	A/0
品名描述 Product Description	无刷直流振动马达 BLDC Vibration Motor		
型号Part No.	W0625AB001F		
送样日期Date			
设计Designed by	审核Checked by	批准Approved by	
陳满	陈满	陈满	
2017.12.12	2017.12.12	2017.12.12	



金龙机电股份有限公司  
Jinlong Machinery & Electronics Co., Ltd.

地址: 中国浙江省乐清市柳江大道金龙科技园

地址Address: Jinlong Science Park, Liujiang Avenue, Yueqing, Zhejiang, China.



网址Website: [www.jinlong-machinery.com](http://www.jinlong-machinery.com)

[sales@jinlong-machinery.com](mailto:sales@jinlong-machinery.com)

PRODUCT	BLDC VIBRATOR	SPECIFICATION	 
MODEL	W0625AB001F		
REVISION NO.	A/0		



**修订记录Revision record**

日期 Date	修订版本 Revision version	修改描述 change Description	作者 Author
2017/12/12	A/0	初版	陈满

PRODUCT	BLDC VIBRATOR	SPECIFICATION	 
MODEL	W0625AB001F		
REVISION NO.	A/0		

## 目 录Table of Contents

修订记录Revision record .....	2
目 录Table of Contents .....	3
1 适用范围General Scope of Application.....	4
2 使用条件Applicable Conditions.....	4
3 测试条件Measurement Conditions .....	4
4 电气性能Electrical Characteristics.....	6
5 马达结构Part list.....	6
6 机械性能Mechanical Characteristics .....	7
7 可靠性能Reliability Tests .....	7
8 判定基准Judgments after Reliability Tests .....	9
9 使用时注意事项Cautions for Use.....	10
10 包装Packing (TBD).....	11
11 外形图Outline drawings .....	12

PRODUCT	BLDC VIBRATOR	SPECIFICATION	 
MODEL	W0625AB001F		
REVISION NO.	A/0		

## 1 适用范围General Scope of Application

本说明书适用于无刷直流振动马达W0625AB001F。

This specification applies to BLDC Vibration Motor model W0625AB001F.



## 2 使用条件Applicable Conditions

项目Item	规格Specification
2.1 额定电压Rated voltage	3.0 V DC
2.2 使用电压范围Operating voltage	2.7~3.3 V DC
2.3 旋转方向Rotation	CW
2.4 使用条件Operating Conditions	温度Temperature-20°C~+60°C, 湿度Ordinary Humidity:65±20%RH
2.5 保存条件Storage Conditions	温度Temperature -30~+85°C, 湿度Ordinary Humidity:65±20%RH

## 3 测试条件Measurement Conditions

正常情况下马达在温度22~28°C和湿度45~85%RH的环境中测试；为保证测试的一致性，所以按下表规定范围内进行：Normal dismounted in 22 to 28 °C temperature and humidity of 45 ~ 85% RH environment test; In order to ensure the consistency of the test, so within the scope as stipulated in the table below:

项目Item	规格Specification
3.1 温度Temperature	25 ± 3°C
3.2 湿度Humidity	65 ± 20% RH
3.3 气压 Atmospheric pressure	1,013 hpa ± 40 hpa

PRODUCT	BLDC VIBRATOR	<b>SPECIFICATION</b>	 
MODEL	W0625AB001F		
REVISION NO.	A/0		

测定方法 Measurement method

3.4

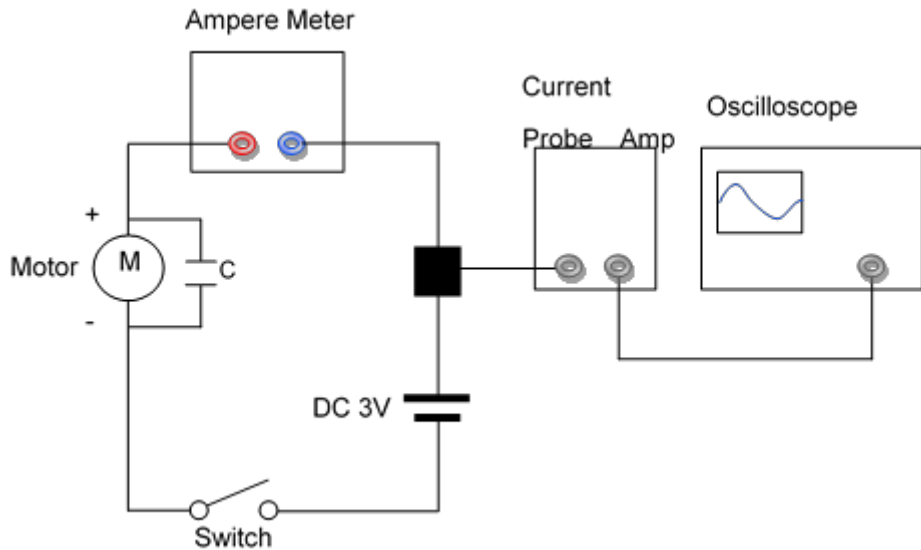

- 测试夹具放置在海棉垫之上 Install jig on the sponge pad;
- 马达安装在夹具里面 Fix the motor inner side of jig;
- 夹具重量 Jig weight : 100g;
- 夹具材料 Material : POM。

回路图 Circuit diagram

3.5

霍尔片通过内置的 Drive IC 向 Coil 供电, Coil 产生电磁力, 此电磁力与转子 rotor 上 magnet 的磁力产生作用, 此时机壳上的霍尔 IC 内置 Drive IC 感应到 magnet 极性, 从而间断向 coil 供应电流使转子连续转动。

The Coil receives current from Drive IC which include whole element. It makes coil get electric force. This electric power and magnet force of installed magnet in Rotor make revolution by Fleming's left hands law. While it happens, the Rotor can spin continually by whole element in Rotor supply current to Coil alternatively through whole element notices magnetic pole.

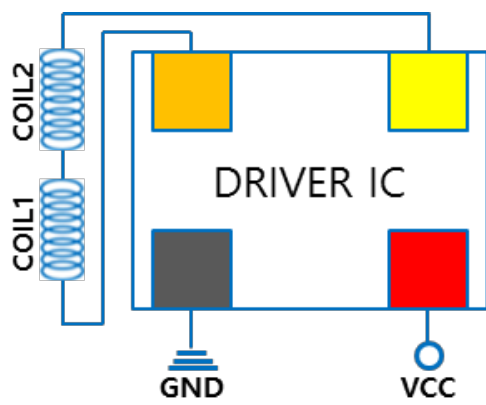

PRODUCT	BLDC VIBRATOR	<b>SPECIFICATION</b>	 
MODEL	W0625AB001F		
REVISION NO.	A/0		

#### 4 电气性能 Electrical Characteristics

项目 Item	规格 Specification	条件 Condition
4.1 额定转速 Rated speed	13,000±3,000rpm	额定电压下 At rated voltage.
4.2 额定消耗电流 Operating consumption current	60mA Max	
4.3 启动电流 Starting current	125mA Max	
4.4 启动电压 Starting voltage	2.5V DC Min	在最小启动电压下启动。 Motor is rotating at minimum starting voltage.
4.5 绝缘电阻 Insulation resistance	10MΩ Min	在100V直流下，端子和机壳间。 At DC 100V between Terminals and case.

#### 5 马达结构 Part list

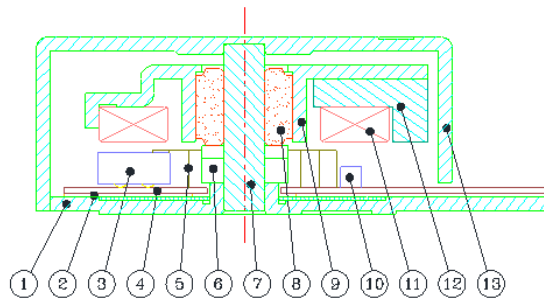

No.	部品	特征及作用	No.	部品	特征及作用
1	Bracket	固定部品	8	Oiless Bearing	旋转支承作用
2	Tape	粘结F-pcb	9	Yoke	防止磁力外漏及固定部品
3	IC	感应和控制作用	10	Capacitor	电容
4	F-pcb	连接电源并提供电源的导通	11	Magnet	磁力作用
5	Coil	电机力作用	12	Weight	产生偏心力作用
6	Washer	高度限位作用	13	Up-Case	防止磁力外漏及保护作用
7	Shaft	轴心作用	14		

PRODUCT	BLDC VIBRATOR	SPECIFICATION	 
MODEL	W0625AB001F		
REVISION NO.	A/0		

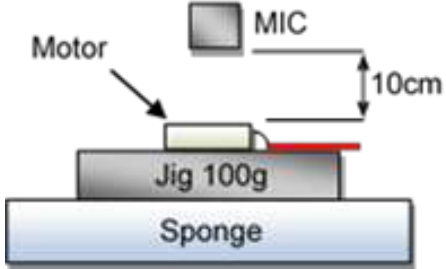

## 6 机械性能 Mechanical Characteristics

项目 Item	规格 Specification
6.1 振动量 Vibration strength	0.4 Grms以上 (在额定电压下, 100g的模板上测试 Measured @100g jig under rated voltage)
6.2 重量/Weight	0.35g±10%
6.3 抗压力 Resistance to pressure	3.0kgf Max
6.4 机械噪音 Mechanical noise	小于50分贝, A计权 50dB (A) Max
<p>在额定电压下。At rated voltage. 背景噪音: 不大于25dB, A计权。 Back ground noise &lt; 25dB, (A)Max.</p> 	



## 7 可靠性能 Reliability Tests

项目 Item	规格 Specification	判定标准 Judgment
7.1 自然跌落 Drop	<p>1) 试验状态 Test mode: 将马达固定在约100克 (包括马达本身) 的物体上, 落向钢板面。 Set the motor to a fixture of approx. 100g (include the motor) and drop it onto the steel surface.</p> <p>2) 高度 Height: 1.5米m</p> <p>3) 方向 Direction: 6面faces 4角horn</p> <p>4) 次数 Number of times: 各3次 Each 3 times (总共30次 Total 30 times drop)</p>	测试结果应符合8.1项要求。The test result should meet the requirements of item 8.1.

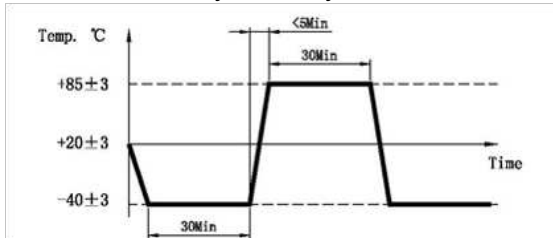

PRODUCT	BLDC VIBRATOR	<b>SPECIFICATION</b>	 
MODEL	W0625AB001F		
REVISION NO.	A/0		

项目Item		规格Specification	判定标准Judgment
7.2	滚筒 Tumbling box	1) 试验状态Test status: 将马达固定在重量约100克(包括马达本身)的物体上, 放在滚筒机内; Fix the motor on a object weighted about 100g (include the motor) and it inside mixing mill; 2) 高度Height: 1米m; 3) 次数: 200 次times.	测试结果应符合8.1 项要求。The test result should meet the requirements of item 8.1.
7.3	低温放置 Low temperature exposure	1) 温度Temperature: $-40\pm 2^{\circ}\text{C}$ 2) 时间Time: 120h	在常温下放置2小时后, 马达应符合8.1项要求。After 2 Hour storage, the test result should meet the requirements of item 8.1.
7.4	高温放置 High temperature exposure	1) 温度Temperature: $+85\pm 2^{\circ}\text{C}$ 2) 时间Time: 120h	
7.5	高湿放置 High Humidity exposure	1) 温度Temperature: $+55\pm 2^{\circ}\text{C}$ 2) 湿度Humidity: $95\pm 3\% \text{RH}$ 3) 放置时间Exposure time: 120h 4) 无水气凝结No condensation of moisture	
7.6	寿命实验 Life test	1) 额定电压Rated voltage: 3.0V DC 2) 试验模式Test mode: 2S On, 1S Off, as 1 cycle. 3) 循环次数Test cycle: 500,000 cycles 	测试结果应符合8.1 项要求。The test result should meet the requirements of item 8.1.
7.7	热冲击实验 Thermal Shock Test	1) 测试模式Test mode: 1 hour at $-40^{\circ}\text{C}$ , 1 hour at $+85^{\circ}\text{C}$ , as one cycle. Transfer time between extreme temperatures: $< 5 \text{分}/5 \text{min}$ 2) 循环次数Test cycle: 50 cycles 	在常温下放置2小时后, 马达应符合8.1项要求。After 2 Hour storage, the test result should meet the requirements of item 8.1.

PRODUCT	BLDC VIBRATOR	SPECIFICATION	 
MODEL	W0625AB001F		
REVISION NO.	A/0		

项目Item	规格Specification	判定标准Judgment
7.8 盐雾试验 Salt spray test	1) 浓度Concentration: 5% Naci 溶液 / 5% Naci solution; 2) PH值value: 6.5--7.2; 3) 试验槽温度Test chamber temperature: 35±2°C; 4) 盐雾沉降量Salt spray deposition: 1--2ml/80cm <sup>2</sup> *h; 5) 试验时Time: 8Hr.	在常温下放置2小时后, 马达应符合8.1项要求。After 2 Hour storage, the test result should meet the requirements of item 8.1.



## 8 判定基准Judgments after Reliability Tests

项目Item	判定基准Requirements
8.1 特性测试 Measurement	1) 额定转速Rated speed: 不低于初始值-30%; 不高于初始值+50%。 No lower than -30% of initial data; No more than +50% of initial data.  2) 额定电流Rated current: 不低于初始值-30%; 不高于初始值+50%。 No lower than -30% of initial data; No more than +50% of initial data.  3) 端阻Terminal resistance: 不大于初始值±15%。 No more than +15% of initial data; No less than -15% of initial data.  4) 起动电压Starting voltage: 不大于3.4V直流电压3.4V DC Max.  5) 绝缘电阻Insulation resistance: 大于3MΩ/3MΩ Min.
8.2 外观检查 Visual inspection	马达外壳不可出现不可擦拭的锈迹。 Non-wipe-able rust on the case is not allowed.

PRODUCT	BLDC VIBRATOR	SPECIFICATION	 
MODEL	W0625AB001F		
REVISION NO.	A/0		

## 9 使用时注意事项Cautions for Use

- 9.1 与规格不同使用的情况下性能和寿命会发生问题，希望注意电压使用范围。You might encounter functional and life problems if you use it different from the standard. Please be careful of the range of use, like voltage etc.
- 9.2 MOTOR使用时一定要把图纸上的红色导线(+)端子连接在 (+)，蓝和黑色导线 (-) 端子连接在(-)后使用。No matter what please connect red lead wire to (+) socket, and blue and black lead wire to (-) socket when you use the motor.
- 9.3 在有害GAS及高温高湿的场所保管对马达造成不良因素所以请注意保管。Please be careful of that the storage in high temperature and humidity and noxious gas might cause hindrances to motors.
- 9.4 为了减少马达旋转时因检查失误造成电源端子短路导致 Drive IC 损伤，请将2 $\mu$ F电容器并联在马达上与电源插头(+ / -)连接。Drive IC can be damaged by power plug short due to careless test. In order to prevent damage of Driver IC.
- 9.5 please connect 2 $\mu$ F condenser to motor in a row(parallel connection) with power plug(+/-).
- 9.6 拿取马达时,尽可能的轻拿Case部分。Please hold the case part lightly as much as you can when you use motors.
- 9.7 为保护Drive IC，请不要施加DC 4.5V以上。Please do not use above DC 4.5V for preventing Driver IC.
- 9.8 马达接近磁性物质或接触时会降低马达性能，因此避免接近强磁场。Please avoid being near and contacting magnetic materials like magnet which might encounter functional problems.
- 9.9 能够自我吸附的物质 (铁、粉末) 及灰尘等与马达混放时会出现转动不良，异常音等，会使马达的性能下降及信赖性受影响,因此取用及作业时应注意环境清洁。If some materials (metal, powder) and dust become mixing condition in the motor it might cause feature declines by occurring rotation faulty and abnormal sound so please be clean the working environment and careful when you deal with the motor.
- 9.10 注意请不要浸泡在液态物质如：水或酒精中。Please be careful of not soaking in liquid like water or alcohol.
- 9.11 包装方法：(参照包装图) 只有在客户要求下变更可能。Packing method: Refer to packing drawing. But, it could be changed on user's demand.
- 9.12 无法保证满足本式样范围以外使用的情况。It can't guarantee if the motors are used out of the range of fulfilling this specification.
- 9.13 本式样书内容的变更及追加是在双方协议下实施。Any further conditions or change of this APPROVAL REQUEST take effect by mutual consent.

PRODUCT	BLDC VIBRATOR	<b>SPECIFICATION</b>	 
MODEL	W0625AB001F		
REVISION NO.	A/0		



## 10 包装Packing (TBD)

### 10.1 内, 外径包装规格The Packing Standard

项目Item	具体内容Specific content			
	材料Material	尺寸Size (mm)	包装数量Packing Qty	包装后重量Weight after packing
Tray 包装	PET	328(L)×240(W)×9.5(H)	100ea Max	About 76 g
Out box 包装	DW-1	510(L)×350(W)×175(H)	5,000ea Max	About 5.4 Kg

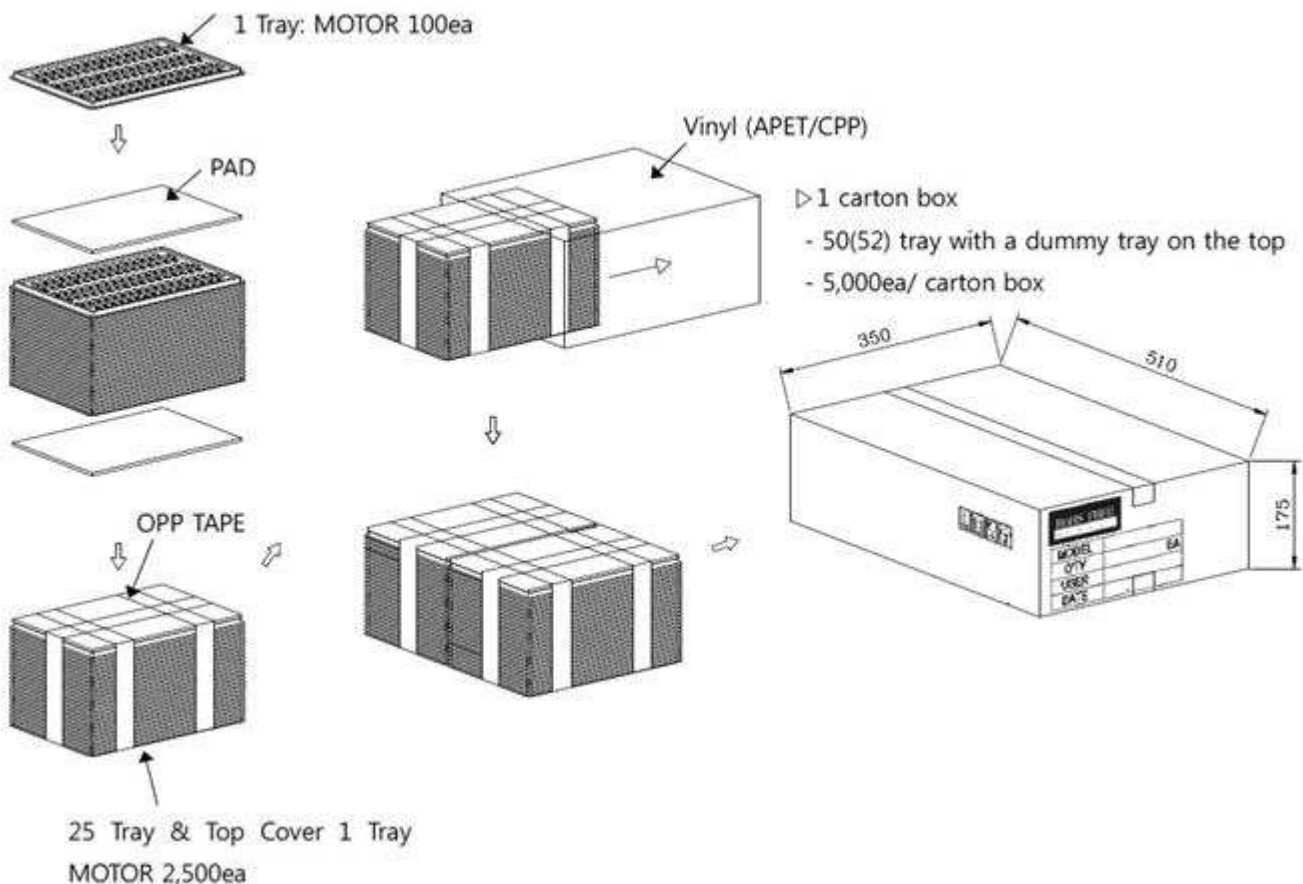
### 10.2 包装图Packing drawing



PRODUCT	BLDC VIBRATOR	<b>SPECIFICATION</b>	 
MODEL	W0625AB001F		
REVISION NO.	A/0		

## 11 外形图 Outline drawings

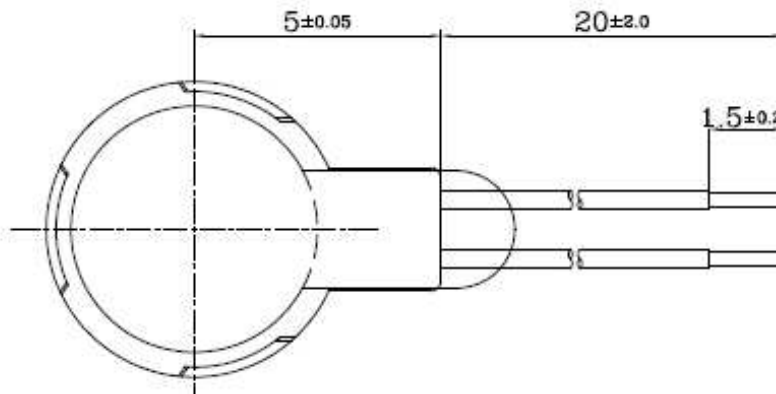
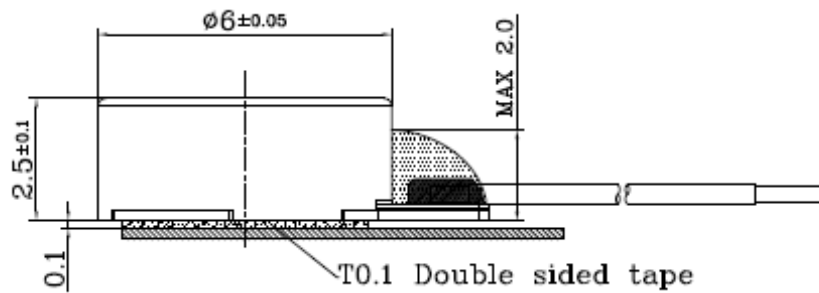
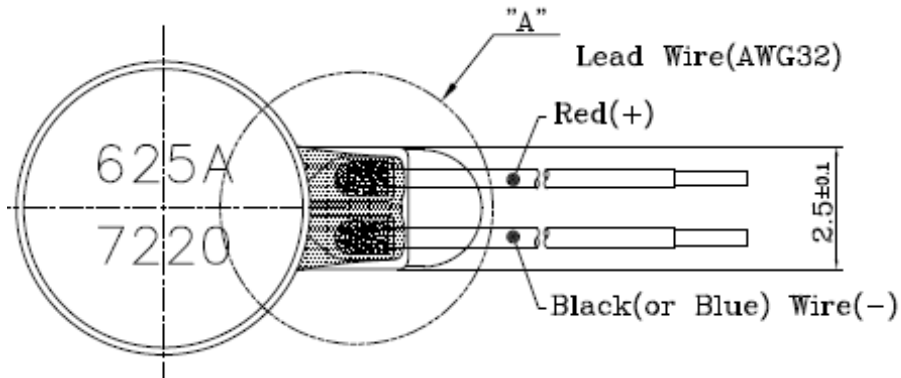

● Label numbering

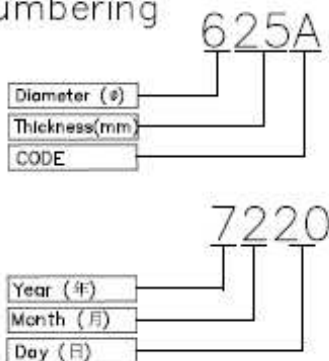

Diameter (ø)	ø10→10 ø9→9, ø6→6, ...
Thickness (mm)	3.4mm→34, 3.0mm→30, 2.7mm→27, ...
CODE	Product LineA→A, Product LineB→B, ...
Year (年)	2015Year→5, 2016Year→6, ...
Month (月)	Jan.→1...Oct.→A...Dec.→C
Day (日)	1Day→01...10Day→10...31Day→31