



Chipsmall Limited consists of a professional team with an average of over 10 year of expertise in the distribution of electronic components. Based in Hongkong, we have already established firm and mutual-benefit business relationships with customers from,Europe,America and south Asia,supplying obsolete and hard-to-find components to meet their specific needs.

With the principle of “Quality Parts,Customers Priority,Honest Operation,and Considerate Service”,our business mainly focus on the distribution of electronic components. Line cards we deal with include Microchip,ALPS,ROHM,Xilinx,Pulse,ON,Everlight and Freescale. Main products comprise IC,Modules,Potentiometer,IC Socket,Relay,Connector.Our parts cover such applications as commercial,industrial, and automotives areas.

We are looking forward to setting up business relationship with you and hope to provide you with the best service and solution. Let us make a better world for our industry!



Contact us

Tel: +86-755-8981 8866 Fax: +86-755-8427 6832

Email & Skype: info@chipsmall.com Web: www.chipsmall.com

Address: A1208, Overseas Decoration Building, #122 Zhenhua RD., Futian, Shenzhen, China



Wireless External Antenna for 2.4 GHz Application

Single-Band Antenna with I-PEX Cable Assembly. Pulse Part Number: W1049B

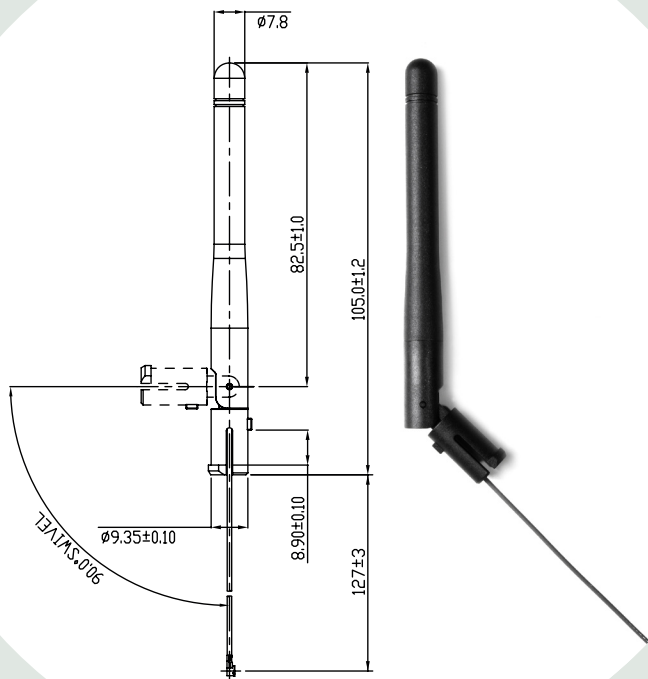

Features

- Shortest antennas in product line
- Omni-directional radiation
- For WLAN devices using WiFi (802.11b/g), Bluetooth®, ZigBee™ and other applications in the ISM 2.4GHz band
- Omnidirectional radiation pattern provides broad 360° coverage
- One-quarter wavelength dipole configuration
- Various cable length from 3 to 12 inch (76-305mm)

Connector

- I-PEX

Pansize 20/bag; 500/carton

Dimensions: $\frac{\text{Inches}}{\text{mm}}$

Unless otherwise specified, all tolerances are $\pm \frac{0.10}{0.25}$

Electrical Specifications @ +25 °C

Note: This part number is lead-free and RoHS compliant. No additional suffix or identifier is required.

Part Number	Frequency [GHz]	Max Gain [dBi]	Impedance [Ω]	Mechanical Length (in/mm)	Cable Length (in/mm)
W1049B030	2.4	2.0	50	3.25/82.5	3/76
W1049B050	2.4	2.0	50	3.25/82.5	5/127
W1049B070	2.4	2.0	50	3.25/82.5	7/178
W1049B090	2.4	2.0	50	3.25/82.5	9/229
W1049B120	2.4	2.0	50	3.25/82.5	12/305

Pulse Finland Oy

Takatie 6
90440 Kempele, Finland
Tel: +358 207 935 500
Fax: +358 207 935 501
www.pulseeng.com/antennas



Wireless External Antenna for 2.4 GHz Application

Single-Band Antenna with I-PEX Cable Assembly. Pulse Part Number: W1049B

Application Notes

Omni-directional antennas provide a uniform, donut-shaped, 360° radiation pattern. The omni-directional pattern is suitable for point-to-multipoint broadcasting in all directions. This antenna is primarily used for WLAN

applications. However, it can also be used for a variety of other applications within the specified frequency range. When used as an access point, the antenna is ideally located at the center of the coverage area.

Gain Performance W1049B030

H-PLANE

2.4GHz 1.55524dBi

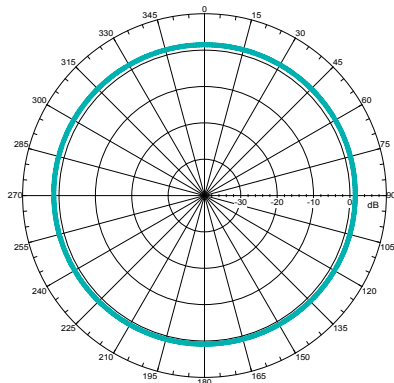

2.45GHz 1.51154dBi

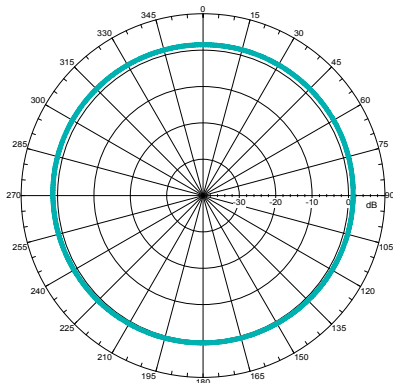

2.5GHz 1.38176dBi

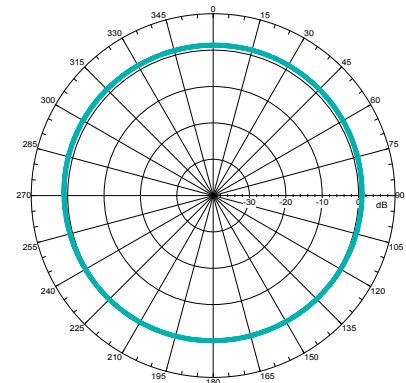

E-PLANE

2.4GHz 1.61476dBi

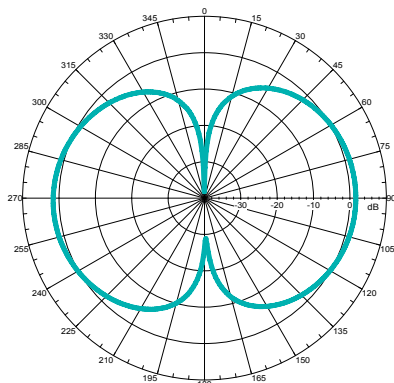

2.45GHz 1.6233dBi

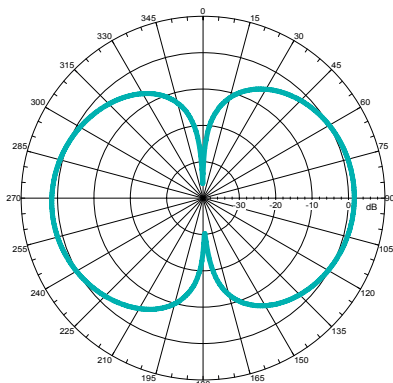

2.5GHz 1.59034dBi

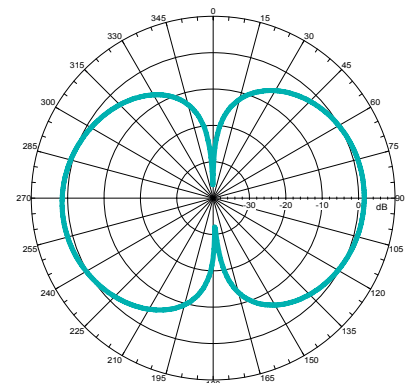

Pulse Finland Oy

Takatie 6
90440 Kempele, Finland
Tel: +358 207 935 500
Fax: +358 207 935 501

www.pulseeng.com/antennas

