



Chipsmall Limited consists of a professional team with an average of over 10 year of expertise in the distribution of electronic components. Based in Hongkong, we have already established firm and mutual-benefit business relationships with customers from,Europe,America and south Asia,supplying obsolete and hard-to-find components to meet their specific needs.

With the principle of "Quality Parts,Customers Priority,Honest Operation,and Considerate Service",our business mainly focus on the distribution of electronic components. Line cards we deal with include Microchip,ALPS,ROHM,Xilinx,Pulse,ON,Everlight and Freescale. Main products comprise IC,Modules,Potentiometer,IC Socket,Relay,Connector.Our parts cover such applications as commercial,industrial, and automotives areas.

We are looking forward to setting up business relationship with you and hope to provide you with the best service and solution. Let us make a better world for our industry!



## Contact us

Tel: +86-755-8981 8866 Fax: +86-755-8427 6832

Email & Skype: info@chipsmall.com Web: www.chipsmall.com

Address: A1208, Overseas Decoration Building, #122 Zhenhua RD., Futian, Shenzhen, China



Description: FPC Antenna 2.4/5.xGHz/DSRC

Series: Internal Antenna

PART NUMBER: W3334XXXXX

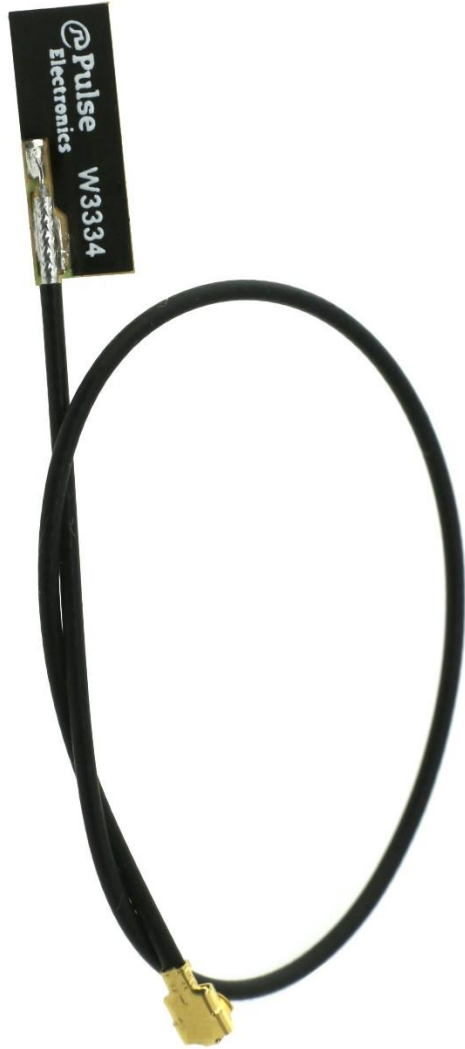

### Features:

- Peak gain 4/5.5dBi
- VSWR 2:1
- Mounting with adhesive tape
- Ultra small flexible radiator 4.3x15.3x0.1mm
- Coax feed cable with U.FL compatible connector

### Applications:

- 2.4/5.xGHz radios
- Dualband WiFi
- Bluetooth, BLE, ZigBee
- DSRC 5.85-5.925GHz
- Routers, set top boxes
- IoT, M2M, V2x

All dimensions are in mm / inches

Issue: 1816

In the effort to improve our products, we reserve the right to make changes judged to be necessary.

CONFIDENTIAL AND PROPRIETARY INFORMATION

This document contains confidential and proprietary information of Pulse Electronics, Inc. (Pulse) and is protected by copyright, trade secret and other state and federal laws. Its receipt or possession does not convey any rights to reproduce, disclose its contents, or to manufacture, use or sell anything it may describe. Reproduction, disclosure or use without specific written authorization of Pulse is strictly forbidden.

For more information:

Pulse Worldwide Headquarters  
15255 Innovation Drive #100  
San Diego, CA 92128  
USA  
Tel: 1-858-674-8100

Pulse/Larsen Antennas  
18110 SE 34<sup>th</sup> St Bldg 2 Suite 250  
Vancouver, WA 98683  
USA  
Tel: 1-360-944-7551

Europe Headquarters  
Pulse GmbH & Do, KG  
Zeppelinstrasse 15  
Herrenberg, Germany  
Tel: 49 7032 7806 0

Pulse (Suzhou) Wireless Products Co, Inc.  
99 Huo Ju Road(#29 Bldg,4<sup>th</sup> Phase  
Suzhou New District  
Jiangsu Province, Suzhou 215009 PR China  
Tel: 86 512 6807 9998



Description: FPC Antenna 2.4/5.xGHz/DSRC

Series: Internal Antenna

PART NUMBER: W3334XXXXX

This document covers all product variants of the following product family:

W3334B0100	100mm 1.13mm OD cable	U.FL compatible connector
W3334B0127	127mm 1.13mm OD cable	U.FL compatible connector
W3334B0150	150mm 1.13mm OD cable	U.FL compatible connector
W3334B0250	250mm 1.13mm OD cable	U.FL compatible connector
W3334B0290	290mm 1.13mm OD cable	U.FL compatible connector

Issue: 1816

In the effort to improve our products, we reserve the right to make changes judged to be necessary.

CONFIDENTIAL AND PROPRIETARY INFORMATION

This document contains confidential and proprietary information of Pulse Electronics, Inc. (Pulse) and is protected by copyright, trade secret and other state and federal laws. Its receipt or possession does not convey any rights to reproduce, disclose its contents, or to manufacture, use or sell anything it may describe. Reproduction, disclosure or use without specific written authorization of Pulse is strictly forbidden.

For more information:

Pulse Worldwide Headquarters  
15255 Innovation Drive #100  
San Diego, CA 92128  
USA  
Tel:1-858-674-8100

Pulse/Larsen Antennas  
18110 SE 34<sup>th</sup> St Bldg 2 Suite 250  
Vancouver, WA 98683  
USA  
Tel: 1-360-944-7551

Europe Headquarters  
Pulse GmbH & Do, KG  
Zeppelinstrasse 15  
Herrenberg, Germany  
Tel: 49 7032 7806 0

Pulse (Suzhou) Wireless Products Co, Inc.  
99 Huo Ju Road(#29 Bldg,4<sup>th</sup> Phase  
Suzhou New District  
Jiangsu Province, Suzhou 215009 PR China  
Tel: 86 512 6807 9998



Description: FPC Antenna 2.4/5.xGHz/DSRC

Series: Internal Antenna

PART NUMBER: W3334XXXXX

**ELECTRICAL SPECIFICATIONS**

Cable Length (mm)	P/N	Frequency (MHz)	Peak Gain (dBi)	Efficiency (%)	VSWR
100	W3334B0100	2400-2500	4+/-1dB	50	2:1
		4900-6000	5.5+/-1dB	70	2.5:1
127	W3334B0127	2400-2500	4+/-1dB	50	2:1
		4900-6000	5.5+/-1dB	70	2:1
150	W3334B0150	2400-2500	4+/-1dB	50	2:1
		4900-6000	5.5+/-1dB	70	2:1
250	W3334B0250	2400-2500	4+/-1dB	50	2:1
		4900-6000	5.5+/-1dB	70	2:1
290	W3334B0290	2400-2500	4+/-1dB	50	2:1
		4900-6000	5.5+/-1dB	70	2:1

**Typical free space performance measured on 1mm thick PC plate**

Issue: 1816

In the effort to improve our products, we reserve the right to make changes judged to be necessary.

CONFIDENTIAL AND PROPRIETARY INFORMATION

This document contains confidential and proprietary information of Pulse Electronics, Inc. (Pulse) and is protected by copyright, trade secret and other state and federal laws. Its receipt or possession does not convey any rights to reproduce, disclose its contents, or to manufacture, use or sell anything it may describe. Reproduction, disclosure or use without specific written authorization of Pulse is strictly forbidden.



Description: FPC Antenna 2.4/5.xGHz/DSRC

Series: Internal Antenna

PART NUMBER: W3334XXXXX

### MECHANICAL SPECIFICATIONS

FPC size	14.3 X 5.3 X 0.1 [0.56 X 0.21 X 0.004]	mm[inch]
Connector type	U.FL compatible	
Cable type	$\varphi = 1.13$ [0.04]	mm[inch]
Cable length	Optional	mm[inch]
Adhesive	3M467	

### ENVIRONMENTAL SPECIFICATIONS

Operating temperature	-40/+85 ° C
-----------------------	-------------

Issue: 1816

In the effort to improve our products, we reserve the right to make changes judged to be necessary.

CONFIDENTIAL AND PROPRIETARY INFORMATION

This document contains confidential and proprietary information of Pulse Electronics, Inc. (Pulse) and is protected by copyright, trade secret and other state and federal laws. Its receipt or possession does not convey any rights to reproduce, disclose its contents, or to manufacture, use or sell anything it may describe. Reproduction, disclosure or use without specific written authorization of Pulse is strictly forbidden.

Description: FPC Antenna 2.4/5.xGHz/DSRC

Series: Internal Antenna

PART NUMBER: W3334XXXXX

MECHANICAL DRAWING

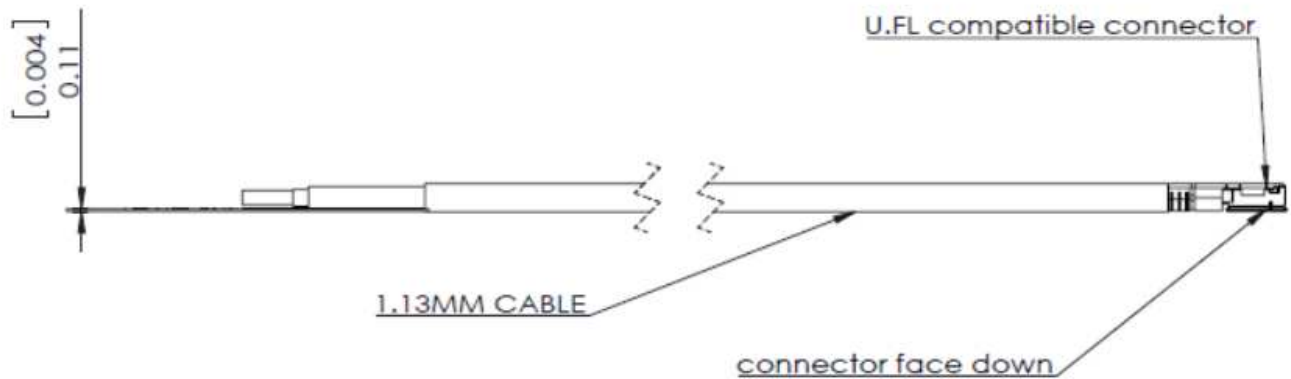

Issue: 1816

In the effort to improve our products, we reserve the right to make changes judged to be necessary.

CONFIDENTIAL AND PROPRIETARY INFORMATION

This document contains confidential and proprietary information of Pulse Electronics, Inc. (Pulse) and is protected by copyright, trade secret and other state and federal laws. Its receipt or possession does not convey any rights to reproduce, disclose its contents, or to manufacture, use or sell anything it may describe. Reproduction, disclosure or use without specific written authorization of Pulse is strictly forbidden.

Description: FPC Antenna 2.4/5.xGHz/DSRC

Series: Internal Antenna

PART NUMBER: W3334XXXXX

CHARTS

VSWR

W3334 measured with polycarbonate plate

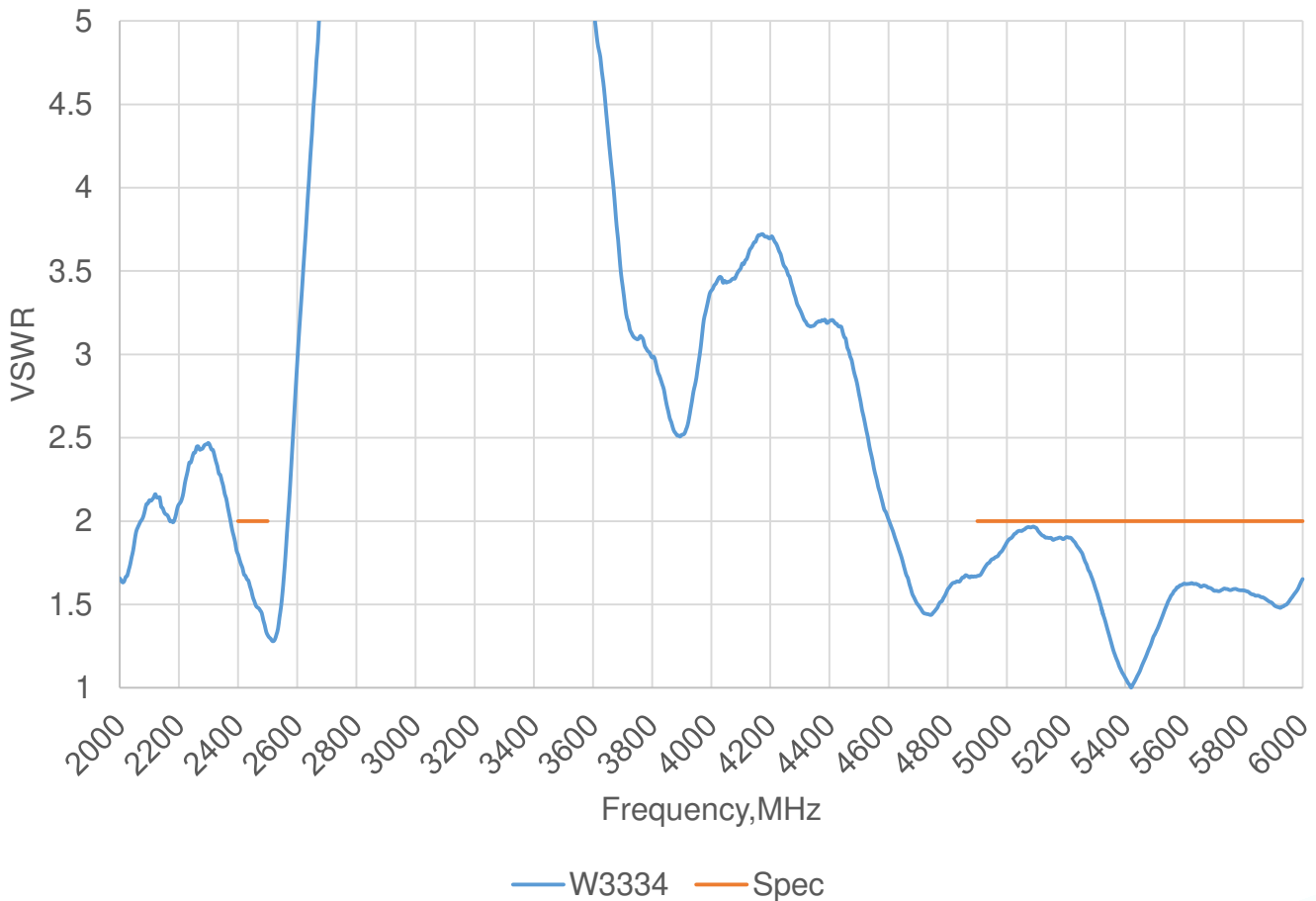

**Note: Antenna tested on 1mm thickness PC plate with 150mm feed cable**

Issue: 1816

In the effort to improve our products, we reserve the right to make changes judged to be necessary.

CONFIDENTIAL AND PROPRIETARY INFORMATION

This document contains confidential and proprietary information of Pulse Electronics, Inc. (Pulse) and is protected by copyright, trade secret and other state and federal laws. Its receipt or possession does not convey any rights to reproduce, disclose its contents, or to manufacture, use or sell anything it may describe. Reproduction, disclosure or use without specific written authorization of Pulse is strictly forbidden.

Description: FPC Antenna 2.4/5.xGHz/DSRC

Series: Internal Antenna

PART NUMBER: W3334XXXXX

CHARTS

Efficiency

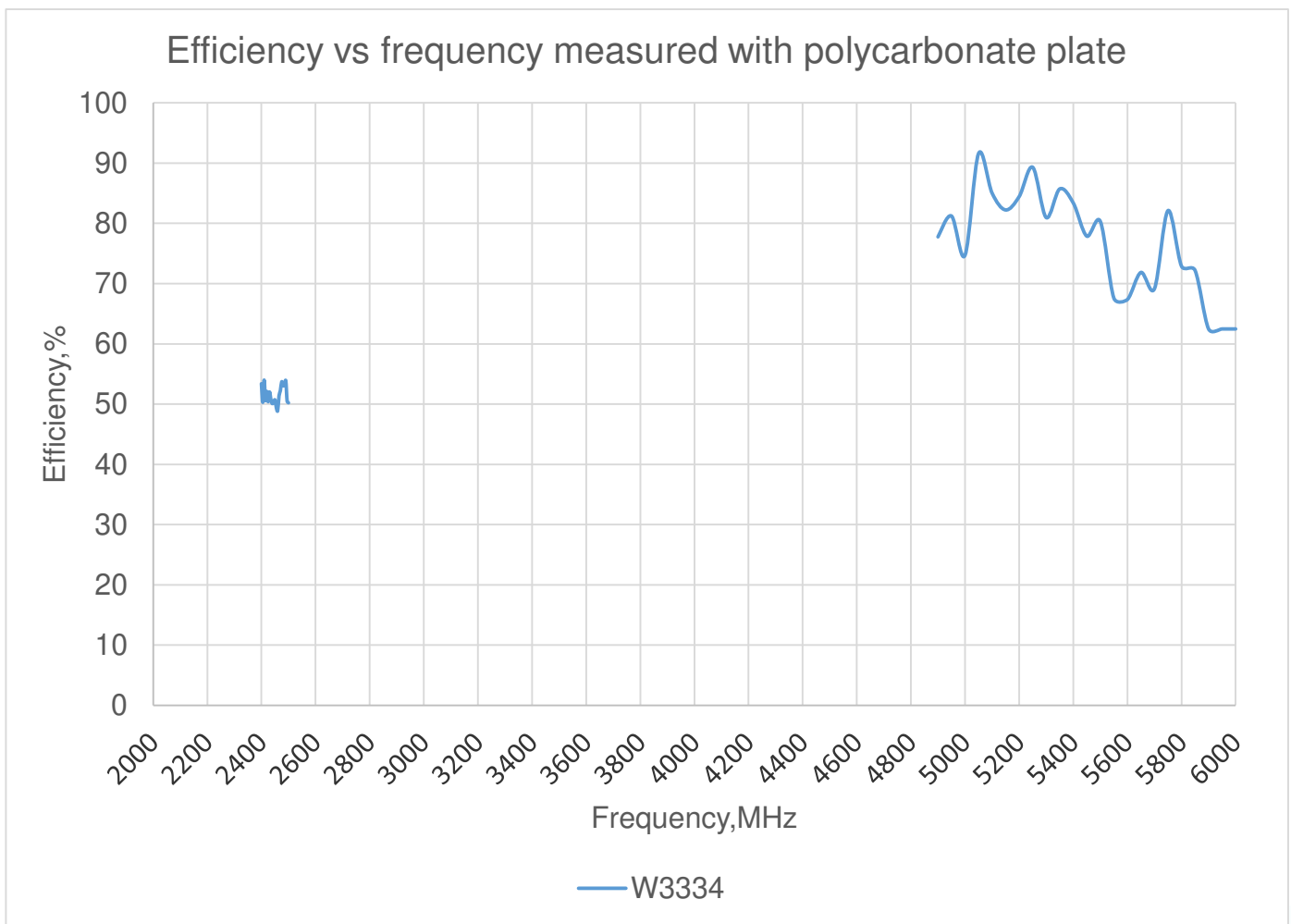

**Note: Antenna tested on 1mm thickness PC plate with 150mm feed cable**

Issue: 1816

In the effort to improve our products, we reserve the right to make changes judged to be necessary.

CONFIDENTIAL AND PROPRIETARY INFORMATION

This document contains confidential and proprietary information of Pulse Electronics, Inc. (Pulse) and is protected by copyright, trade secret and other state and federal laws. Its receipt or possession does not convey any rights to reproduce, disclose its contents, or to manufacture, use or sell anything it may describe. Reproduction, disclosure or use without specific written authorization of Pulse is strictly forbidden.



Description: FPC Antenna 2.4/5.xGHz/DSRC

Series: Internal Antenna

PART NUMBER: W3334XXXXX

CHARTS

Peak Gain

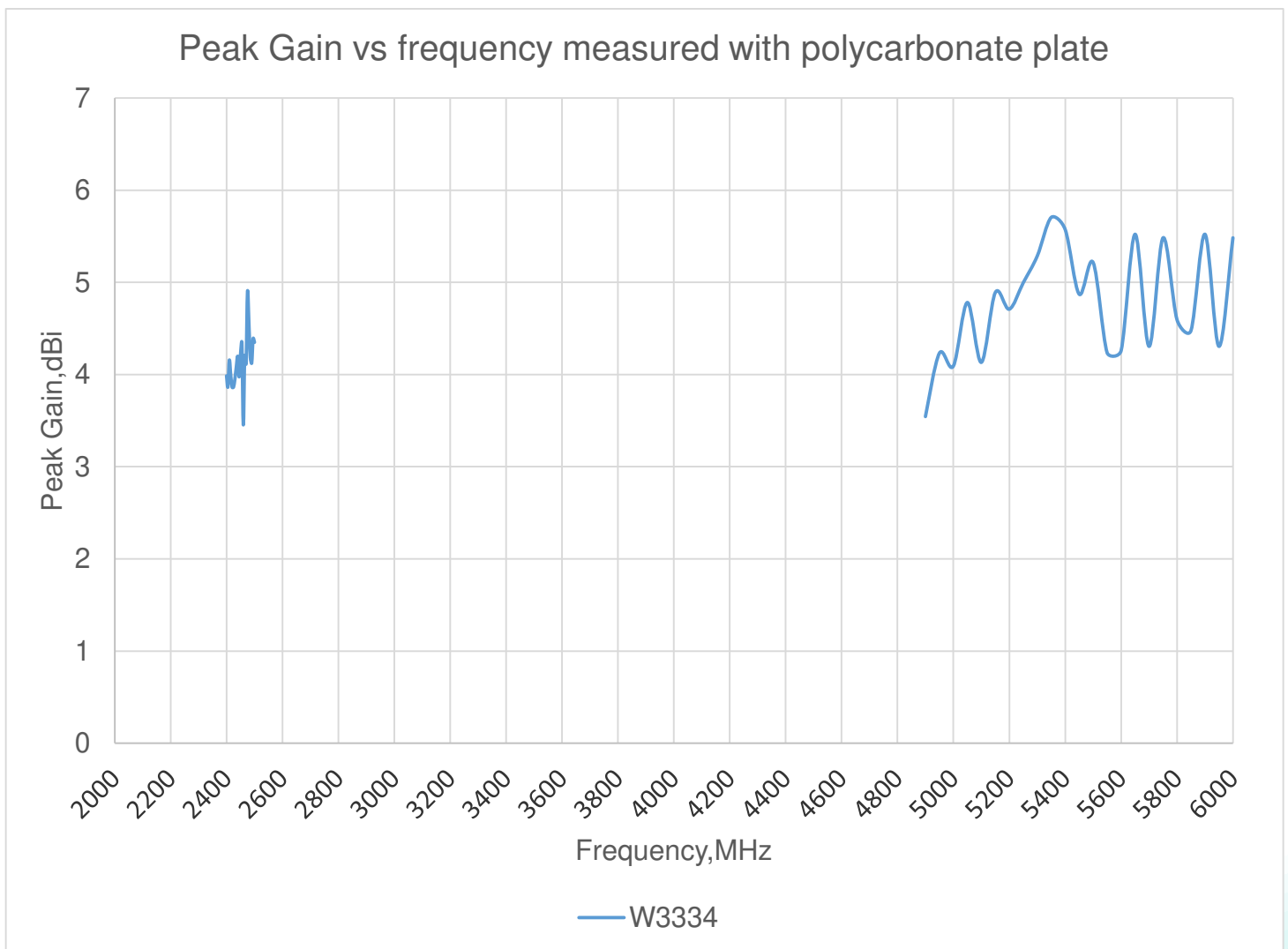

**Note: Antenna tested on 1mm thickness PC plate with 150mm feed cable**

Issue: 1816

In the effort to improve our products, we reserve the right to make changes judged to be necessary.

CONFIDENTIAL AND PROPRIETARY INFORMATION

This document contains confidential and proprietary information of Pulse Electronics, Inc. (Pulse) and is protected by copyright, trade secret and other state and federal laws. Its receipt or possession does not convey any rights to reproduce, disclose its contents, or to manufacture, use or sell anything it may describe. Reproduction, disclosure or use without specific written authorization of Pulse is strictly forbidden.

Description: FPC Antenna 2.4/5.xGHz/DSRC

Series: Internal Antenna

PART NUMBER: W3334XXXXX

CHARTS

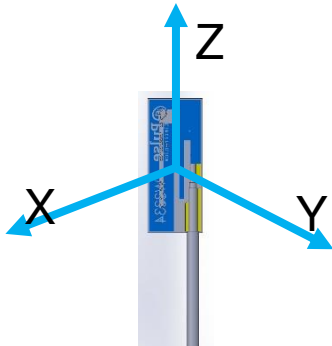

Gain Plots

XY Plane

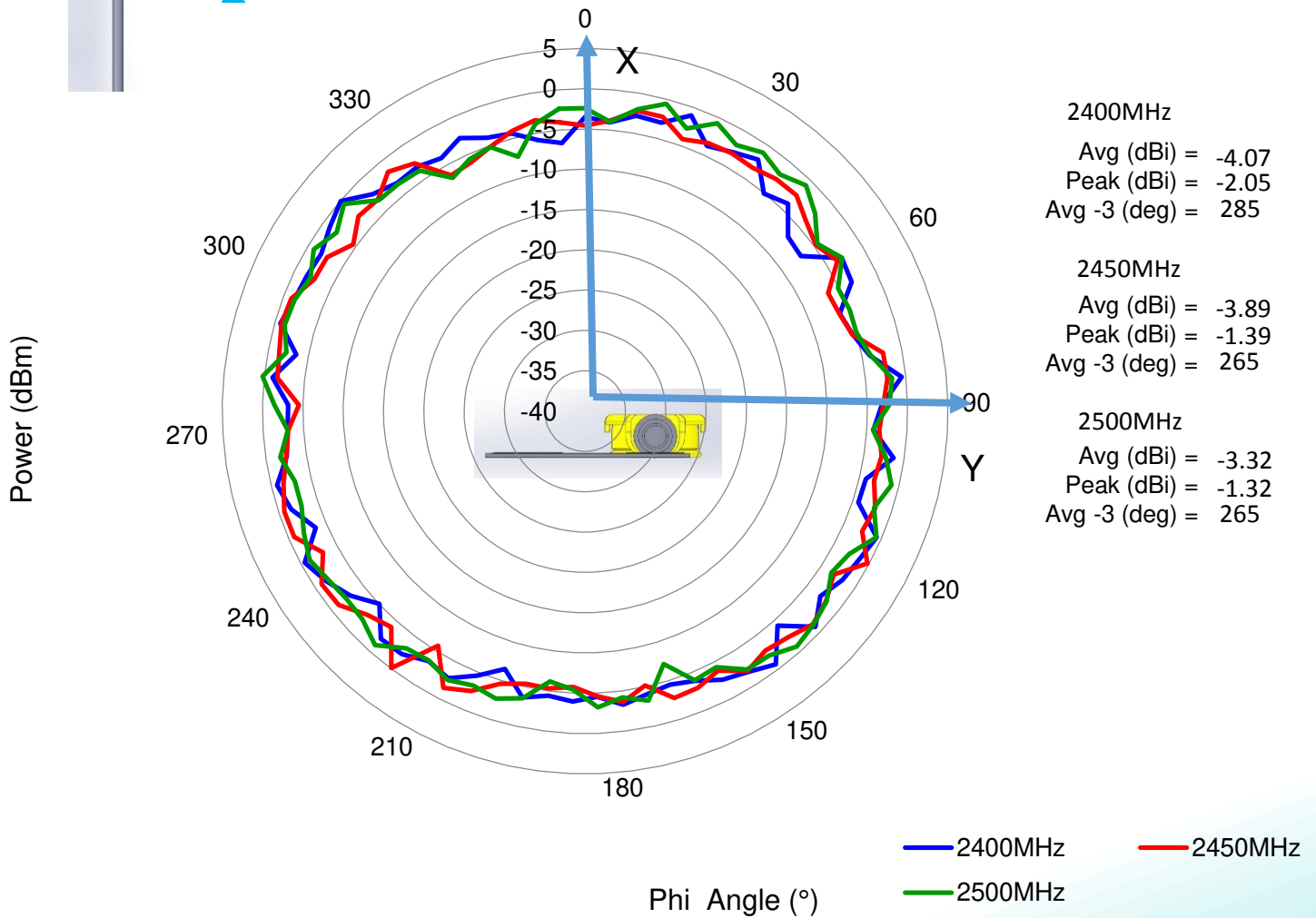

**Note: Antenna tested on 1mm thickness PC plate with 150mm feed cable**

Issue: 1816

In the effort to improve our products, we reserve the right to make changes judged to be necessary.

CONFIDENTIAL AND PROPRIETARY INFORMATION

This document contains confidential and proprietary information of Pulse Electronics, Inc. (Pulse) and is protected by copyright, trade secret and other state and federal laws. Its receipt or possession does not convey any rights to reproduce, disclose its contents, or to manufacture, use or sell anything it may describe. Reproduction, disclosure or use without specific written authorization of Pulse is strictly forbidden.

Description: FPC Antenna 2.4/5.xGHz/DSRC

Series: Internal Antenna

PART NUMBER: W3334XXXXX

CHARTS

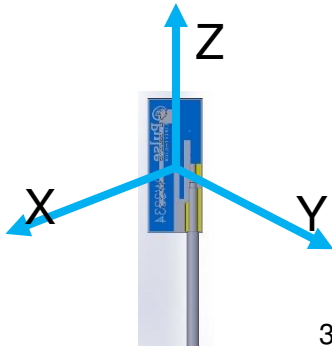

Gain Plots

ZX Plane

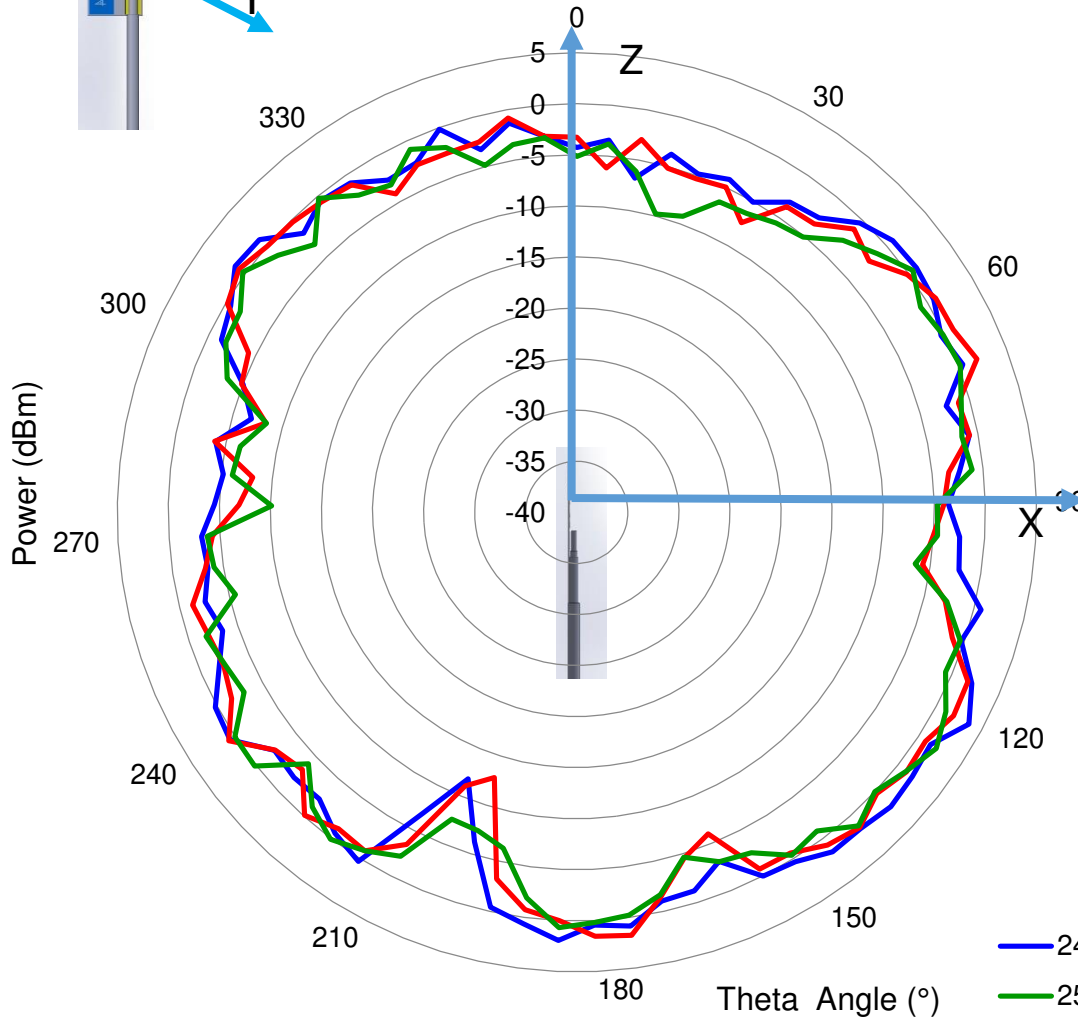

2400MHz  
Avg (dBi) = -4.38  
Peak (dBi) = 1.16  
Avg -3 (deg) = 110

2450MHz  
Avg (dBi) = -4.99  
Peak (dBi) = -0.27  
Avg -3 (deg) = 165

2500MHz  
Avg (dBi) = -4.66  
Peak (dBi) = 0.27  
Avg -3 (deg) = 140

— 2400MHz — 2450MHz  
— 2500MHz

**Note: Antenna tested on 1mm thickness PC plate with 150mm feed cable**

Issue: 1816

In the effort to improve our products, we reserve the right to make changes judged to be necessary.

CONFIDENTIAL AND PROPRIETARY INFORMATION

This document contains confidential and proprietary information of Pulse Electronics, Inc. (Pulse) and is protected by copyright, trade secret and other state and federal laws. Its receipt or possession does not convey any rights to reproduce, disclose its contents, or to manufacture, use or sell anything it may describe. Reproduction, disclosure or use without specific written authorization of Pulse is strictly forbidden.

Description: FPC Antenna 2.4/5.xGHz/DSRC

Series: Internal Antenna

PART NUMBER: W3334XXXXX

CHARTS

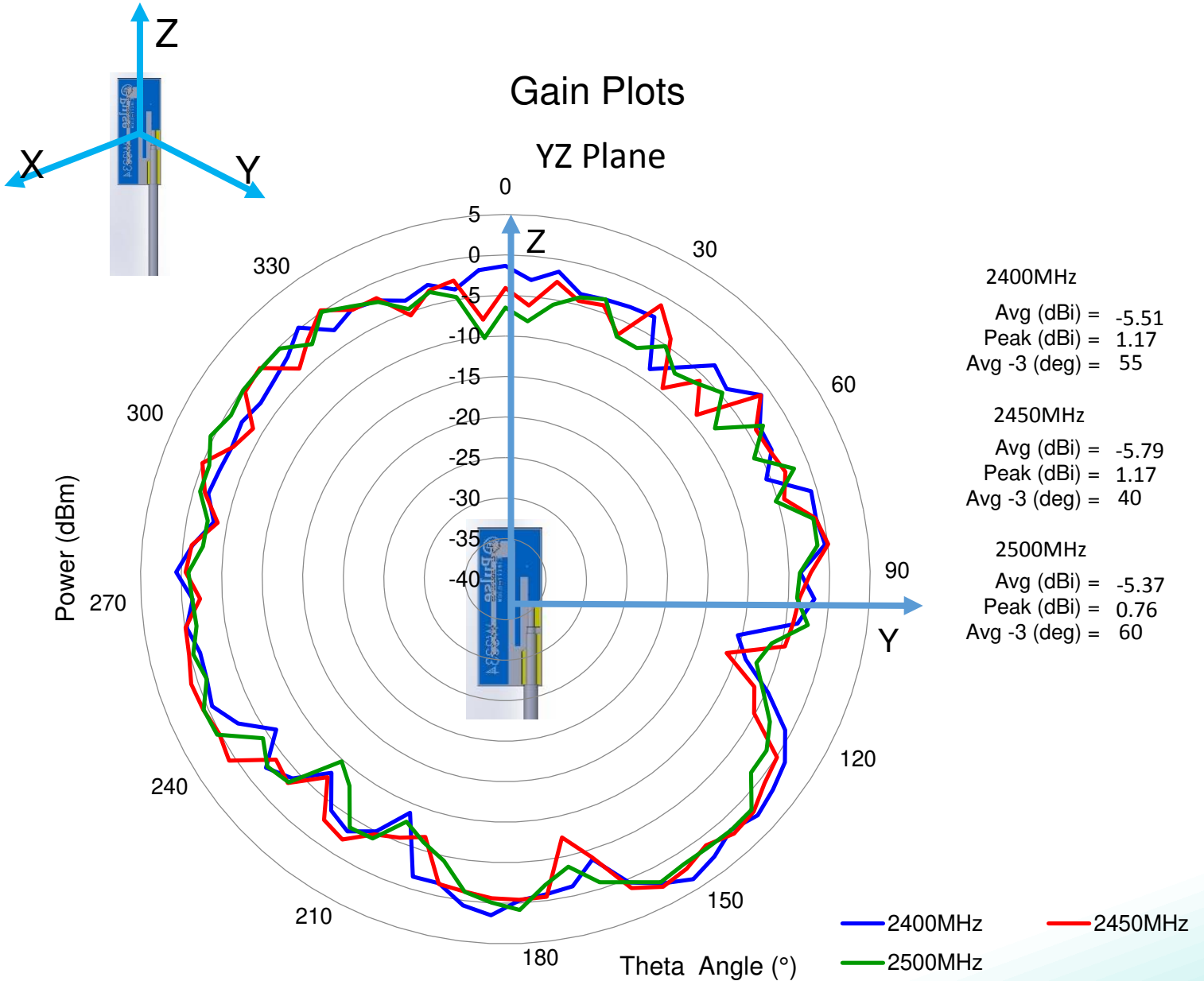

**Note: Antenna tested on 1mm thickness PC plate with 150mm feed cable**

Issue: 1816

In the effort to improve our products, we reserve the right to make changes judged to be necessary.

CONFIDENTIAL AND PROPRIETARY INFORMATION

This document contains confidential and proprietary information of Pulse Electronics, Inc. (Pulse) and is protected by copyright, trade secret and other state and federal laws. Its receipt or possession does not convey any rights to reproduce, disclose its contents, or to manufacture, use or sell anything it may describe. Reproduction, disclosure or use without specific written authorization of Pulse is strictly forbidden.

Description: FPC Antenna 2.4/5.xGHz/DSRC

Series: Internal Antenna

PART NUMBER: W3334XXXXX

CHARTS

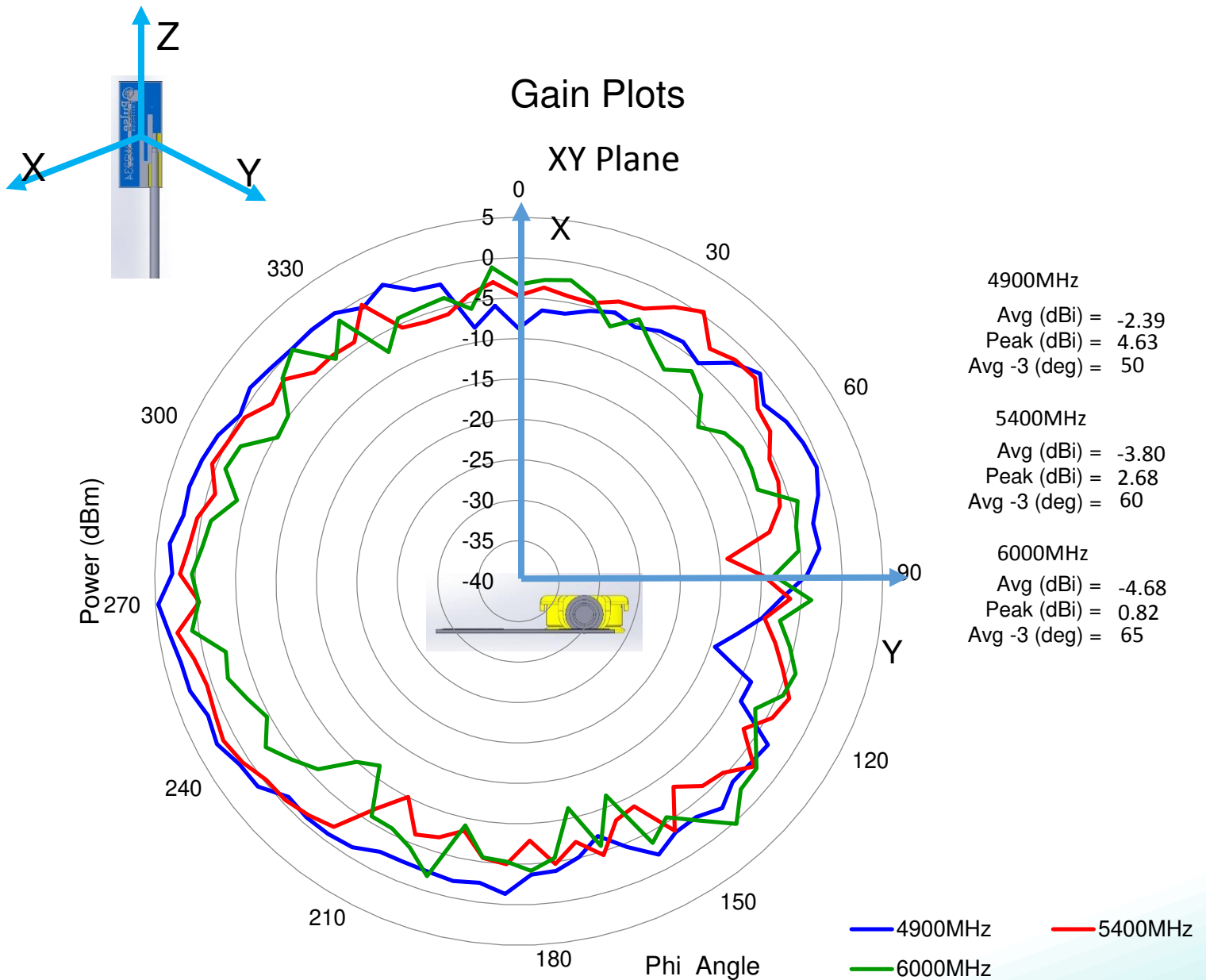

**Note: Antenna tested on 1mm thickness PC plate with 150mm feed cable**

Issue: 1816

In the effort to improve our products, we reserve the right to make changes judged to be necessary.

CONFIDENTIAL AND PROPRIETARY INFORMATION

This document contains confidential and proprietary information of Pulse Electronics, Inc. (Pulse) and is protected by copyright, trade secret and other state and federal laws. Its receipt or possession does not convey any rights to reproduce, disclose its contents, or to manufacture, use or sell anything it may describe. Reproduction, disclosure or use without specific written authorization of Pulse is strictly forbidden.

Description: FPC Antenna 2.4/5.xGHz/DSRC

Series: Internal Antenna

PART NUMBER: W3334XXXXX

CHARTS

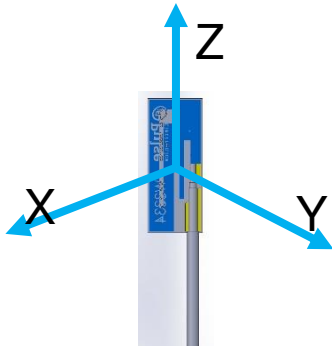

Gain Plots

ZX Plane

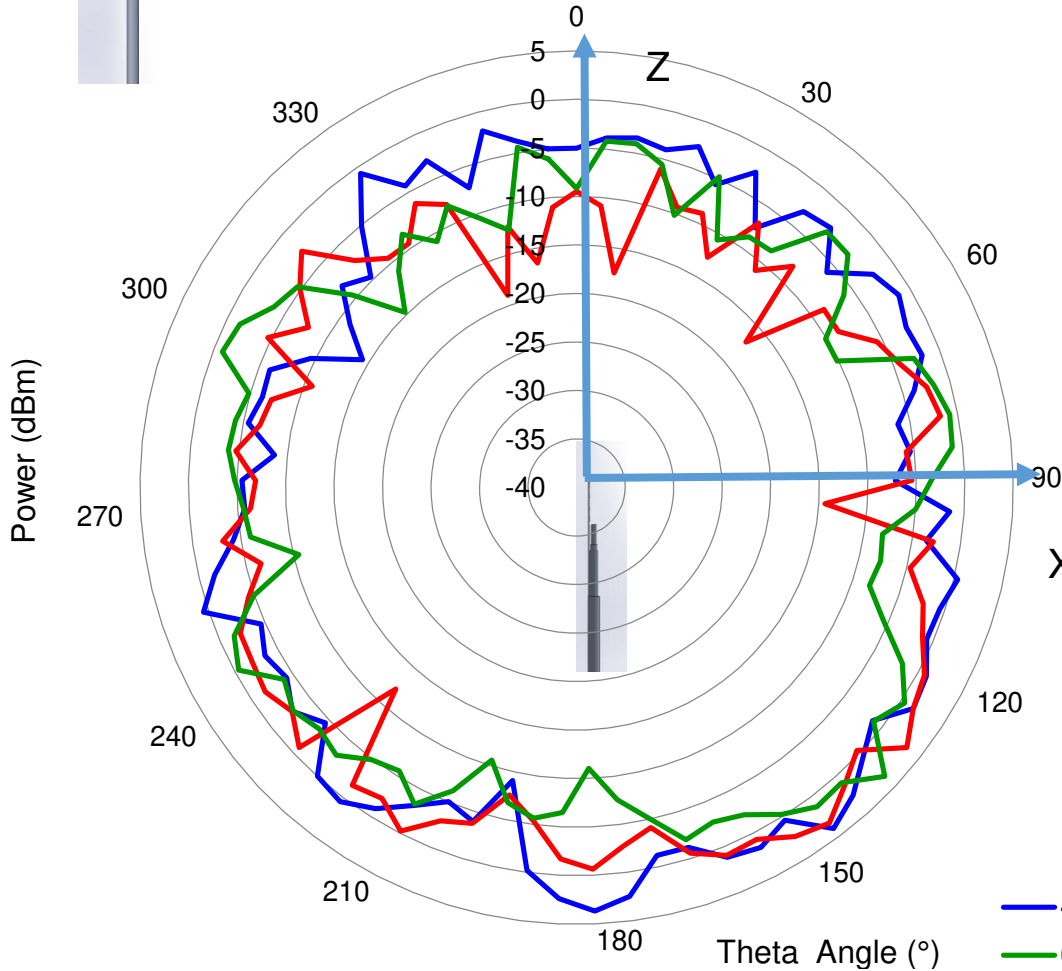

4900MHz  
Avg (dBi) = -3.30  
Peak (dBi) = 3.99  
Avg -3 (deg) = 35

5400MHz  
Avg (dBi) = -5.52  
Peak (dBi) = 3.32  
Avg -3 (deg) = 35

6000MHz  
Avg (dBi) = -5.24  
Peak (dBi) = 3.52  
Avg -3 (deg) = 10

— 4900MHz — 5400MHz  
— 6000MHz

**Note: Antenna tested on 1mm thickness PC plate with 150mm feed cable**

Issue: 1816

In the effort to improve our products, we reserve the right to make changes judged to be necessary.

CONFIDENTIAL AND PROPRIETARY INFORMATION

This document contains confidential and proprietary information of Pulse Electronics, Inc. (Pulse) and is protected by copyright, trade secret and other state and federal laws. Its receipt or possession does not convey any rights to reproduce, disclose its contents, or to manufacture, use or sell anything it may describe. Reproduction, disclosure or use without specific written authorization of Pulse is strictly forbidden.

Description: FPC Antenna 2.4/5.xGHz/DSRC

Series: Internal Antenna

PART NUMBER: W3334XXXXX

CHARTS

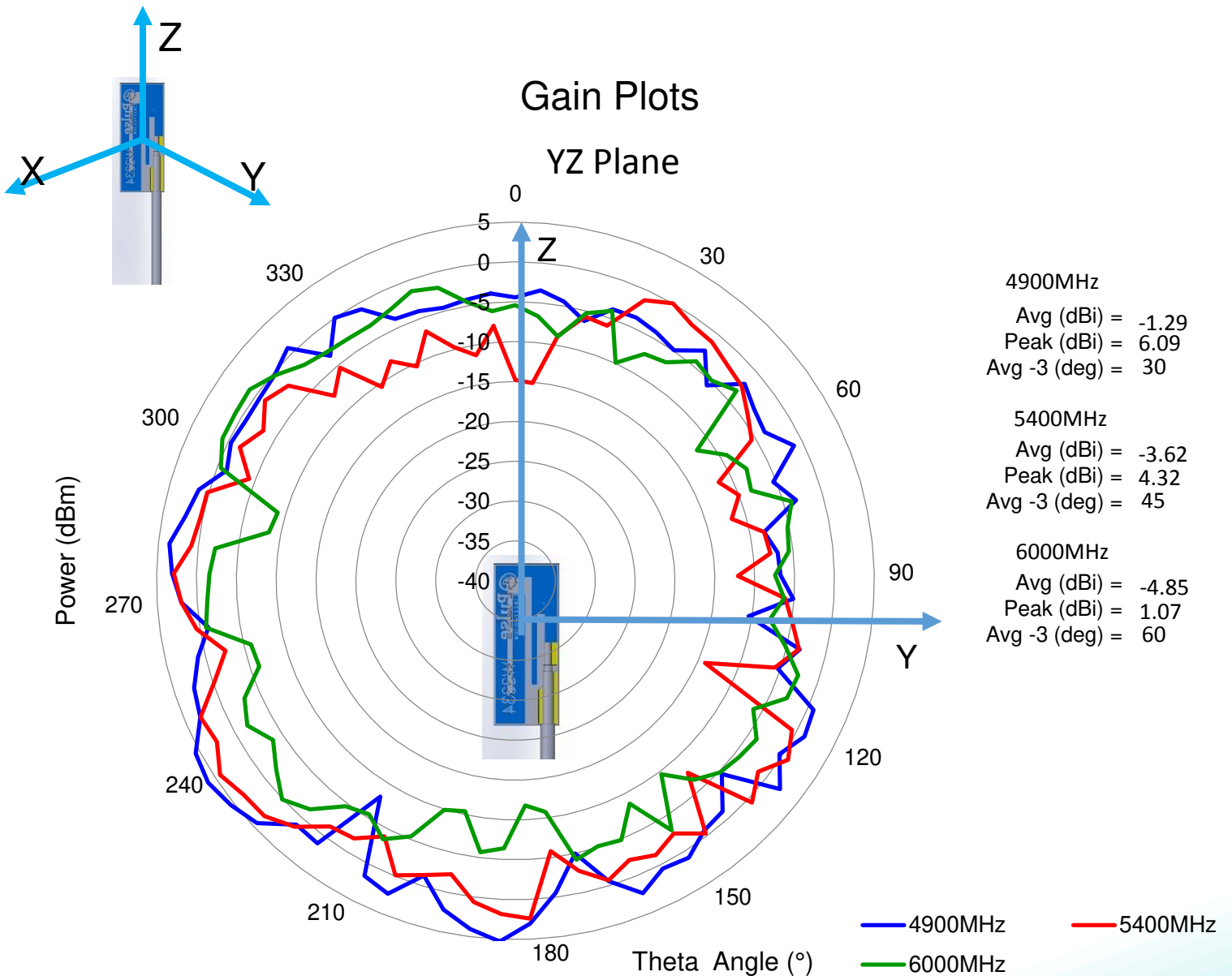

**Note: Antenna tested on 1mm thickness PC plate with 150mm feed cable**

Issue: 1816

In the effort to improve our products, we reserve the right to make changes judged to be necessary.

CONFIDENTIAL AND PROPRIETARY INFORMATION

This document contains confidential and proprietary information of Pulse Electronics, Inc. (Pulse) and is protected by copyright, trade secret and other state and federal laws. Its receipt or possession does not convey any rights to reproduce, disclose its contents, or to manufacture, use or sell anything it may describe. Reproduction, disclosure or use without specific written authorization of Pulse is strictly forbidden.

Description: FPC Antenna 2.4/5.xGHz/DSRC

Series: Internal Antenna

PART NUMBER: W3334XXXXX

## PACKAGING

5PCS/PE bag  
20 PE bag/foam bag  
12 foam bag/ carton box

Total 1200PCS/Carton box



Issue: 1816

In the effort to improve our products, we reserve the right to make changes judged to be necessary.

CONFIDENTIAL AND PROPRIETARY INFORMATION

This document contains confidential and proprietary information of Pulse Electronics, Inc. (Pulse) and is protected by copyright, trade secret and other state and federal laws. Its receipt or possession does not convey any rights to reproduce, disclose its contents, or to manufacture, use or sell anything it may describe. Reproduction, disclosure or use without specific written authorization of Pulse is strictly forbidden.