



Chipsmall Limited consists of a professional team with an average of over 10 year of expertise in the distribution of electronic components. Based in Hongkong, we have already established firm and mutual-benefit business relationships with customers from,Europe,America and south Asia,supplying obsolete and hard-to-find components to meet their specific needs.

With the principle of “Quality Parts,Customers Priority,Honest Operation,and Considerate Service”,our business mainly focus on the distribution of electronic components. Line cards we deal with include Microchip,ALPS,ROHM,Xilinx,Pulse,ON,Everlight and Freescale. Main products comprise IC,Modules,Potentiometer,IC Socket,Relay,Connector.Our parts cover such applications as commercial,industrial, and automotives areas.

We are looking forward to setting up business relationship with you and hope to provide you with the best service and solution. Let us make a better world for our industry!



Contact us

Tel: +86-755-8981 8866 Fax: +86-755-8427 6832

Email & Skype: info@chipsmall.com Web: www.chipsmall.com

Address: A1208, Overseas Decoration Building, #122 Zhenhua RD., Futian, Shenzhen, China



8-BIT MICROCONTROLLER

Table of Contents-

1.	GENERAL DESCRIPTION	2
2.	FEATURES.....	2
3.	PIN CONFIGURATIONS	3
4.	PIN DESCRIPTION	4
5.	FUNCTIONAL DESCRIPTION	6
6.	MEMORY ORGANIZATION	8
7.	INSTRUCTION	32
8.	INSTRUCTION TIMING	33
9.	POWER MANAGEMENT	41
10.	RESET CONDITIONS	42
11.	RESET STATE	44
12.	PROGRAMMABLE TIMERS/COUNTERS	49
13.	TIMED ACCESS PROTECTION	65
14.	H/W REBOOT MODE (BOOT FROM 4K BYTES OF LDFLASH)	67
15.	IN-SYSTEM PROGRAMMING	68
	15.1 The Loader Program locates at LDFLASH memory.	68
	15.2 The Loader Program locates at APFLASH memory.	68
16.	ON-CHIP FLASH EPROM CHARACTERISTICS.....	69
17.	SECURITY BITS.....	72
18.	ELECTRICAL CHARACTERISTIC.....	73
	18.1 Absolute Maximum Ratings.....	73
	18.2 DC Characteristics	73
	18.3 AC Characteristics.....	75
19.	TYPICAL APPLICATION CIRCUITS	80
	19.1 Crystal connections	80
	19.2 Expanded External Data Memory and Oscillator.....	81
20.	PACKAGE DIMENSIONS.....	82
	20.1 40-pin DIP.....	82
	20.2 44-pin PLCC.....	82
	20.3 44-pin QFP	83
21.	APPLICATION NOTE	84
	21.1 In-system Programming Software Examples	84
22.	REVISION HISTORY.....	89

1. GENERAL DESCRIPTION

The W77L516A is a fast 8051 compatible microcontroller with a redesigned processor core without wasted clock and memory cycles. As a result, it executes every 8051 instruction faster than the original 8051 for the same crystal speed. Typically, the instruction executing time of W77L516A is 1.5 to 3 times faster than that of traditional 8051, depending on the type of instruction. In general, the overall performance is about 2.5 times better than the original for the same crystal speed. Giving the same throughput with lower clock speed, power consumption has been improved. Consequently, the W77L516A is a fully static CMOS design; it can also be operated at a lower crystal clock. The W77L516A contains In-System Programmable (ISP) 64 KB AP Flash EPROM; 4KB LD Flash EPROM for loader program; operating voltage from 2.7V to 5.5V; on-chip 1 KB MOVX SRAM; two power saving modes.

2. FEATURES

- 8-bit CMOS microcontroller
- High speed architecture of 4 clocks/machine cycle runs up to 20 MHz
- Pin compatible with standard 80C52
- Instruction-set compatible with MCS-51
- Four 8-bit I/O Ports; Port 0 has internal pull-up resistors enabled by software
- One extra 4-bit I/O port and Wait State control signal (available on 44-pin PLCC/QFP package)
- Three 16-bit Timers
- 12 interrupt sources with two levels of priority
- On-chip oscillator and clock circuitry
- Two enhanced full duplex serial ports
- 64KB In-System Programmable Flash EPROM(APFLASH)
- 4KB Auxiliary Flash EPROM for loader program (LDFLASH)
- 256 bytes scratch-pad RAM
- 1 KB on-chip SRAM for MOVX instruction
- Programmable Watchdog Timer
- Software Reset
- Dual 16-bit Data Pointers
- Software programmable access cycle to external RAM/peripherals
- Packages:
 - Lead Free(RoHs) DIP 40: W77L516A25DL
 - Lead Free(RoHs) PLCC 44: W77L516A25PL
 - Lead Free(RoHs) QFP 44: W77L516A25FL

3. PIN CONFIGURATIONS

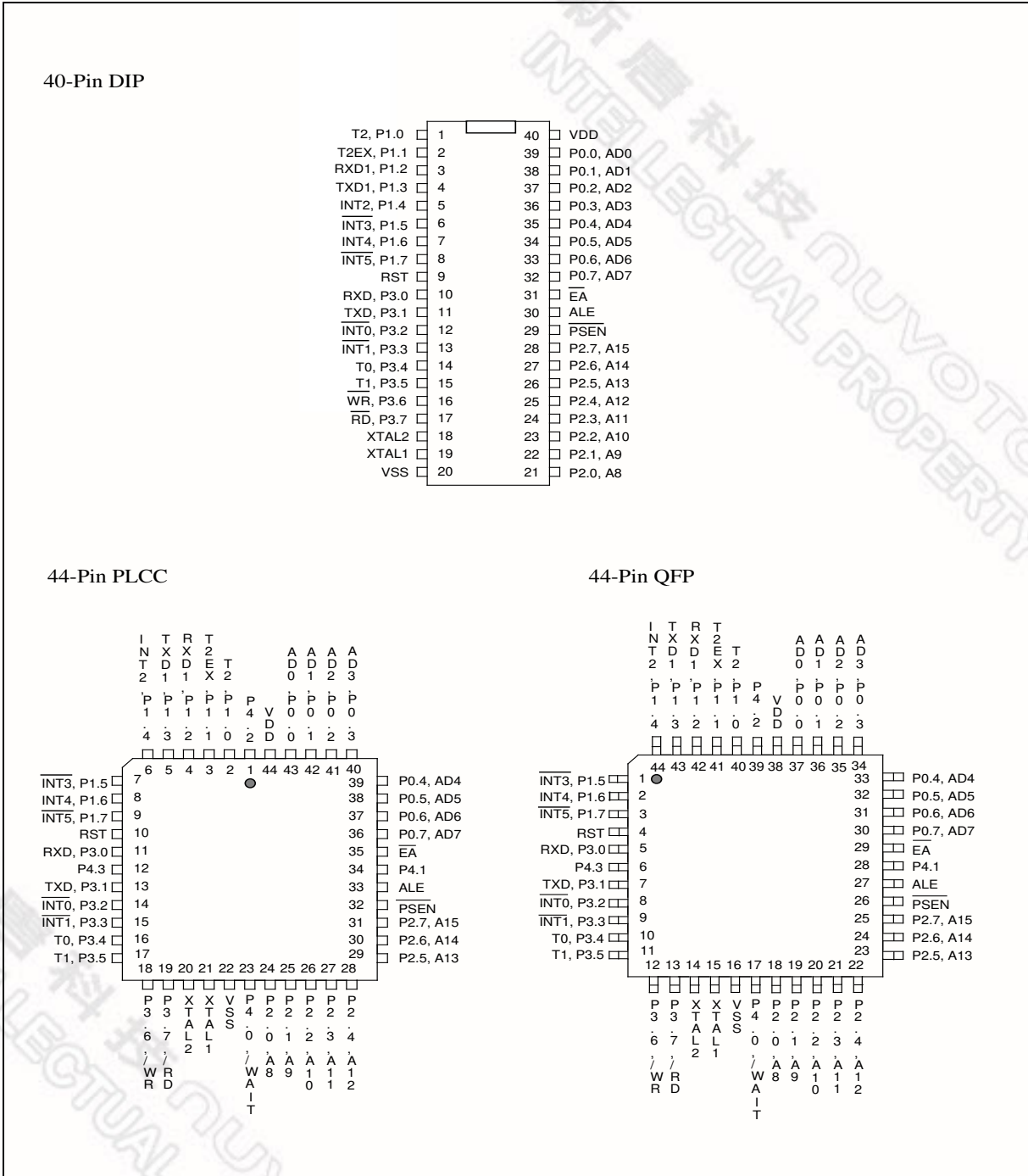

4. PIN DESCRIPTION

SYMBOL	TYPE	DESCRIPTIONS
\overline{EA}	I	EXTERNAL ACCESS ENABLE: This pin forces the processor to execute out of external ROM. It should be kept high to access internal ROM. The ROM address and data will not be present on the bus if \overline{EA} pin is high. Otherwise they will be present on the bus.
\overline{PSEN}	O	PROGRAM STORE ENABLE: \overline{PSEN} enables the external ROM data onto the Port 0 address/data bus during fetch and MOVC operations. When internal ROM access is performed, no \overline{PSEN} strobe signal outputs from this pin.
ALE	O	ADDRESS LATCH ENABLE: ALE is used to enable the address latch that separates the address from the data on Port 0.
RST	I	RESET: A high on this pin for two machine cycles while the oscillator is running resets the device.
XTAL1	I	CRYSTAL1: This is the crystal oscillator input. This pin may be driven by an external clock.
XTAL2	O	CRYSTAL2: This is the crystal oscillator output. It is the inversion of XTAL1.
VSS	I	GROUND: Ground potential
VDD	I	POWER SUPPLY: Supply voltage for operation.
P0.0–P0.7	I/O	PORT 0: Port 0 is an open-drain bi-directional I/O port. This port also provides a multiplexed low order address/data bus during accesses to external memory. Port 0 has internal pull-up resistors enabled by software.
P1.0–P1.7	I/O	PORT 1: Port 1 is a bi-directional I/O port with internal pull-ups. The bits have alternate functions which are described below: T2(P1.0): Timer/Counter 2 external count input T2EX(P1.1): Timer/Counter 2 Reload/Capture/Direction control RXD1(P1.2): Serial port 2 RXD TXD1(P1.3): Serial port 2 TXD INT2(P1.4): External Interrupt 2 $\overline{INT3}$ (P1.5): External Interrupt 3 INT4(P1.6): External Interrupt 4 $\overline{INT5}$ (P1.7): External Interrupt 5
P2.0–P2.7	I/O	PORT 2: Port 2 is a bi-directional I/O port with internal pull-ups. This port also provides the upper address bits for accesses to external memory. The P2.6 and P2.7 also provide the alternate function /REBOOT which is H/W reboot from LD flash.

Pin Description, continued

SYMBOL	TYPE	DESCRIPTIONS
P3.0–P3.7	I/O	<p>PORT 3: Port 3 is a bi-directional I/O port with internal pull-ups. All bits have alternate functions, which are described below:</p> <p>RXD(P3.0) : Serial Port 0 input TXD(P3.1) : Serial Port 0 output $\overline{\text{INT0}}$ (P3.2) : External Interrupt 0 $\overline{\text{INT1}}$ (P3.3) : External Interrupt 1 T0(P3.4) : Timer 0 External Input T1(P3.5) : Timer 1 External Input $\overline{\text{WR}}$ (P3.6) : External Data Memory Write Strobe $\overline{\text{RD}}$ (P3.7) : External Data Memory Read Strobe</p>
P4.0–P4.3	I/O	<p>PORT 4: Port 4 is a 4-bit bi-directional I/O port. The P4.0 also provides the alternate function $\overline{\text{WAIT}}$ which is the wait state control signal. The P4.3 also provide the alternate function /REBOOT which is H/W reboot from LD flash.</p>

* **Note:** **TYPE** I: input, O: output, I/O: bi-directional.

5. FUNCTIONAL DESCRIPTION

The W77L516A is 8052 pin compatible and instruction set compatible. It includes the resources of the standard 8052 such as four 8-bit I/O Ports, three 16-bit timer/counters, full duplex serial port and interrupt sources.

The W77L516A features a faster running and better performance 8-bit CPU with a redesigned core processor without wasted clock and memory cycles. It improves the performance not just by running at high frequency but also by reducing the machine cycle duration from the standard 8052 period of twelve clocks to four clock cycles for the majority of instructions. This improves performance by an average of 1.5 to 3 times. The W77L516A also provides dual Data Pointers (DPTRs) to speed up block data memory transfers. It can also adjust the duration of the MOVX instruction (access to off-chip data memory) between two machine cycles and nine machine cycles. This flexibility allows the W77L516A to work efficiently with both fast and slow RAMs and peripheral devices. In addition, the W77L516A contains on-chip 1KB MOVX SRAM, the address of which is between 0000H and 03FFH. It only can be accessed by MOVX instruction; this on-chip SRAM is optional under software control.

The W77L516A is an 8052 compatible device that gives the user the features of the original 8052 device, but with improved speed and power consumption characteristics. It has the same instruction set as the 8051 family, with one addition: DEC DPTR (op-code A5H, the DPTR is decreased by 1). While the original 8051 family was designed to operate at 12 clock periods per machine cycle, the W77L516A operates at a much reduced clock rate of only 4 clock periods per machine cycle. This naturally speeds up the execution of instructions. Consequently, the W77L516A can run at a higher speed as compared to the original 8052, even if the same crystal is used. Since the W77L516A is a fully static CMOS design, it can also be operated at a lower crystal clock, giving the same throughput in terms of instruction execution, yet reducing the power consumption.

The 4 clocks per machine cycle feature in the W77L516A is responsible for a three-fold increase in execution speed. The W77L516A has all the standard features of the 8052, and has a few extra peripherals and features as well.

I/O Ports

The W77L516A has four 8-bit ports and one extra 4-bit port. Port 0 can be used as an Address/Data bus when external program is running or external memory/device is accessed by MOVC or MOVX instruction. In these cases, it has strong pull-ups and pull-downs, and does not need any external pull-ups. Otherwise it can be used as a general I/O port with open-drain circuit. Port 2 is used chiefly as the upper 8-bits of the Address bus when port 0 is used as an address/data bus. It also has strong pull-ups and pull-downs when it serves as an address bus. Port 1 and 3 act as I/O ports with alternate functions. Port 4 is only available on 44-pin PLCC/QFP package type. It serves as a general purpose I/O port as Port 1 and Port 3. The P4.0 has an alternate function $\overline{CP/RL2}$ which is the wait state control signal. When wait state control signal is enabled, P4.0 is input only.

Serial I/O

The W77L516A has two enhanced serial ports that are functionally similar to the serial port of the original 8052 family. However the serial ports on the W77L516A can operate in different modes in order to obtain timing similarity as well. **Note that the serial port 0 can use Timer 1 or 2 as baud rate generator, but the serial port 1 can only use Timer 1 as baud rate generator.** The serial ports have the enhanced features of Automatic Address recognition and Frame Error detection.

Timers

The W77L516A has three 16-bit timers that are functionally similar to the timers of the 8052 family. When used as timers, they can be set to run at either 4 clocks or 12 clocks per count, thus providing the user with the option of operating in a mode that emulates the timing of the original 8052. The W77L516A has an additional feature, the watchdog timer. This timer is used as a System Monitor or as a very long time period timer.

Interrupts

The Interrupt structure in the W77L516A is slightly different from that of the standard 8052. Due to the presence of additional features and peripherals, the number of interrupt sources and vectors has been increased. The W77L516A provides 12 interrupt resources with two priority level, including six external interrupt sources, timer interrupts, serial I/O interrupts.

Data Pointers

The original 8052 had only one 16-bit Data Pointer (DPL, DPH). In the W77L516A, there is an additional 16-bit Data Pointer (DPL1, DPH1). This new Data Pointer uses two SFR locations which were unused in the original 8052. In addition there is an added instruction, DEC DPTR (op-code A5H), which helps in improving programming flexibility for the user.

Power Management

Like the standard 80C52, the W77L516A also has IDLE and POWER DOWN modes of operation. The W77L516A provides a new Economy mode which allow user to switch the internal clock rate divided by either 4, 64 or 1024. In the IDLE mode, the clock to the CPU core is stopped while the timers, serial ports and interrupts clock continue to operate. In the POWER DOWN mode, all the clock are stopped and the chip operation is completely stopped. This is the lowest power consumption state.

On-chip Data SRAM

The W77L516A has 1K Bytes of data space SRAM which is read/write accessible and is memory mapped. This on-chip MOVX SRAM is reached by the MOVX instruction. It is not used for executable program memory. There is no conflict or overlap among the 256 bytes Scratchpad RAM and the 1K Bytes MOVX SRAM as they use different addressing modes and separate instructions. The on-chip MOVX SRAM is enabled by setting the DME0 bit in the PMR register. After a reset, the DME0 bit is cleared such that the on-chip MOVX SRAM is disabled, and all data memory spaces 0000H–FFFFH access to the external memory.

6. MEMORY ORGANIZATION

The W77L516A separates the memory into two separate sections, the Program Memory and the Data Memory. The Program Memory is used to store the instruction op-codes, while the Data Memory is used to store data or for memory mapped devices.

Program Memory

The Program Memory on the standard 8052 can only be addressed to 64 Kbytes long. All instructions are fetched for execution from this memory area. The MOVX instruction can also access this memory region. There is an auxiliary 4KB Flash EPROM bank (LDFLASH) resided user loader program for In-System Programming (ISP). APFLASH allows serial or parallel download according to user loader program in LDFLASH.

Data Memory

The W77L516A can access up to 64Kbytes of external Data Memory. This memory region is accessed by the MOVX instructions. Unlike the 8051 derivatives, the W77L516A contains on-chip 1K bytes MOVX SRAM of Data Memory, which can only be accessed by MOVX instructions. These 1K bytes of SRAM are between address 0000H and 03FFH. Access to the on-chip MOVX SRAM is optional under software control. When enabled by software, any MOVX instruction that uses this area will go to the on-chip RAM. MOVX addresses greater than 03FFH automatically go to external memory through Port 0 and 2. When disabled, the 1KB memory area is transparent to the system memory map. Any MOVX directed to the space between 0000H and FFFFH goes to the expanded bus on Port 0 and 2. This is the default condition. In addition, the W77L516A has the standard 256 bytes of on-chip Scratchpad RAM. This can be accessed either by direct addressing or by indirect addressing. There are also some Special Function Registers (SFRs), which can only be accessed by direct addressing. Since the Scratchpad RAM is only 256 bytes, it can be used only when data contents are small. In the event that larger data contents are present, two selections can be used. One is on-chip MOVX SRAM, the other is the external Data Memory. The on-chip MOVX SRAM can only be accessed by a MOVX instruction, the same as that for external Data Memory. However, the on-chip RAM has the fastest access times.

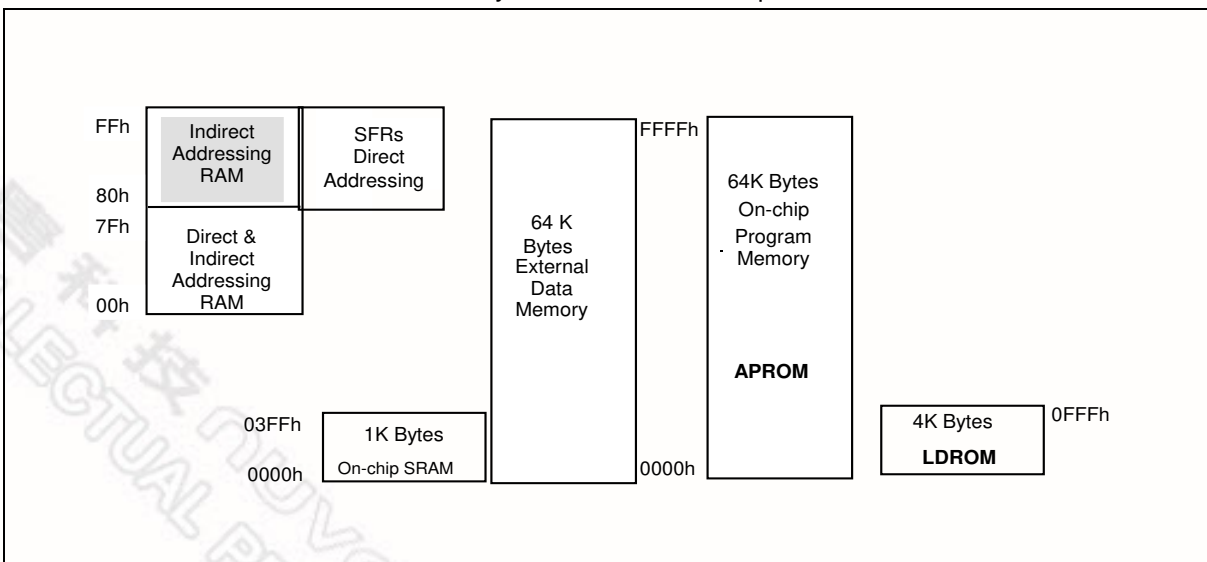

Figure 1. Memory Map

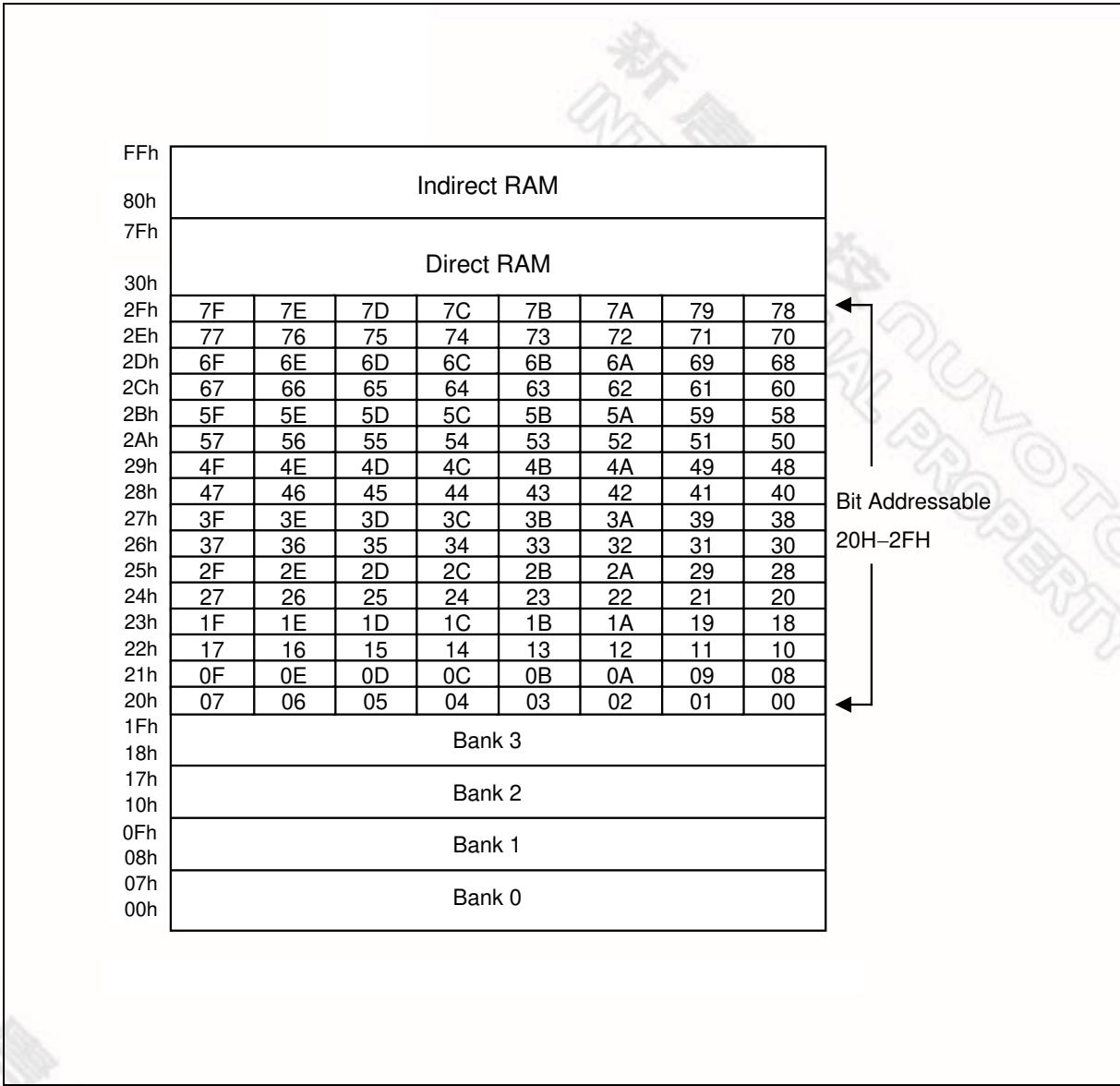

Figure 2. Scratchpad RAM/Register Addressing

Special Function Registers

The W77L516A uses Special Function Registers (SFRs) to control and monitor peripherals and their Modes.

The SFRs reside in the register locations 80-FFh and are accessed by direct addressing only. Some of the SFRs are bit addressable. This is very useful in cases where one wishes to modify a particular bit without changing the others. The SFRs that are bit addressable are those whose addresses end in 0 or 8. The W77L516A contains all the SFRs present in the standard 8052. However, some additional SFRs have been added. In some cases unused bits in the original 8052 have been given new functions. The list of SFRs is as follows. The table is condensed with eight locations per row. Empty locations indicate that there are no registers at these addresses. When a bit or register is not implemented, it will read high.

Table 1. Special Function Register Location Table

F8	EIP							
F0	B							
E8	EIE							
E0	ACC							
D8	WDCON							
D0	PSW							
C8	T2CON	T2MOD	RCAP2L	RCAP2H	TL2	TH2		
C0	SCON1	SBUF1	WCON		PMR	STATUS		TA
B8	IP	SADEN	SADEN1					
B0	P3							
A8	IE	SADDR	SADDR1	ROMCON	SFRAL	SFRAH	SDFDFD	SFRCN
A0	P2		P4CSIN			P4		
98	SCON0	SBUF	P42AL	P42AH	P43AL	P43AH		CHPCON
90	P1	EXIF	P4CONA	P4CONB	P40AL	P40AH	P41AL	P41AH
88	TCON	TMOD	TL0	TL1	TH0	TH1	CKCON	
80	P0	SP	DPL	DPH	DPL1	DPH1	DPS	PCON

Note: The SFRs in the column with dark borders are bit-addressable.

A brief description of the SFRs now follows.

PORT 0

Bit:	7	6	5	4	3	2	1	0
	P0.7	P0.6	P0.5	P0.4	P0.3	P0.2	P0.1	P0.0

Mnemonic: P0

Address: 80h

Port 0 is an open-drain bi-directional I/O port. This port also provides a multiplexed low order address/data bus during accesses to external memory. Besides, it has internal pull-up resistors enabled by setting P0UP of P4CSIN (A2H) to high.

STACK POINTER

Bit:	7	6	5	4	3	2	1	0
	SP.7	SP.6	SP.5	SP.4	SP.3	SP.2	SP.1	SP.0

Mnemonic: SP

Address: 81h

The Stack Pointer stores the Scratchpad RAM address where the stack begins. In other words, it always points to the top of the stack.

DATA POINTER LOW

Bit:	7	6	5	4	3	2	1	0
	DPL.7	DPL.6	DPL.5	DPL.4	DPL.3	DPL.2	DPL.1	DPL.0

Mnemonic: DPL

Address: 82h

This is the low byte of the standard 8052 16-bit data pointer.

DATA POINTER HIGH

Bit:	7	6	5	4	3	2	1	0
	DPH.7	DPH.6	DPH.5	DPH.4	DPH.3	DPH.2	DPH.1	DPH.0

Mnemonic: DPH

Address: 83h

This is the high byte of the standard 8052 16-bit data pointer.

DATA POINTER LOW1

Bit:	7	6	5	4	3	2	1	0
	DPL1.7	DPL1.6	DPL1.5	DPL1.4	DPL1.3	DPL1.2	DPL1.1	DPL1.0

Mnemonic: DPL1

Address: 84h

This is the low byte of the new additional 16-bit data pointer that has been added to the W77L516A. The user can switch between DPL, DPH and DPL1, DPH1 simply by setting register DPS = 1. The instructions that use DPTR will now access DPL1 and DPH1 in place of DPL and DPH. If they are not required they can be used as conventional register locations by the user.

DATA POINTER HIGH1

Bit:	7	6	5	4	3	2	1	0
	DPH1.7	DPH1.6	DPH1.5	DPH1.4	DPH1.3	DPH1.2	DPH1.1	DPH1.0

Mnemonic: DPH1

Address: 85h

This is the high byte of the new additional 16-bit data pointer that has been added to the W77L516A. The user can switch between DPL, DPH and DPL1, DPH1 simply by setting register DPS = 1. The instructions that use DPTR will now access DPL1 and DPH1 in place of DPL and DPH. If they are not required they can be used as conventional register locations by the user.

DATA POINTER SELECT

Bit:	7	6	5	4	3	2	1	0
	-	-	-	-	-	-	-	DPS.0

Mnemonic: DPS

Address: 86h

DPS.0: This bit is used to select either the DPL,DPH pair or the DPL1,DPH1 pair as the active Data Pointer. When set to 1, DPL1, DPH1 will be selected, otherwise DPL,DPH will be selected.

DPS.1-7: These bits are reserved, but will read 0.

POWER CONTROL

Bit:	7	6	5	4	3	2	1	0
	SMOD	SMOD0	-	-	GF1	GF0	PD	IDL

Mnemonic: PCON

Address: 87h

SMOD : This bit doubles the serial port baud rate in mode 1, 2, and 3 when set to 1.

SMOD0: Framing Error Detection Enable: When SMOD0 is set to 1, then SCON.7(SCON1.7) indicates a Frame Error and acts as the FE(FE_1) flag. When SMOD0 is 0, then SCON.7(SCON1.7) acts as per the standard 8052 function.

GF1-0: These two bits are general purpose user flags.

PD: Setting this bit causes the W77L516A to go into the POWER DOWN mode. In this mode all the clocks are stopped and program execution is frozen.

IDL: Setting this bit causes the W77L516A to go into the IDLE mode. In this mode the clocks to the CPU are stopped, so program execution is frozen. But the clock to the serial, timer and interrupt blocks is not stopped, and these blocks continue operating.

TIMER CONTROL

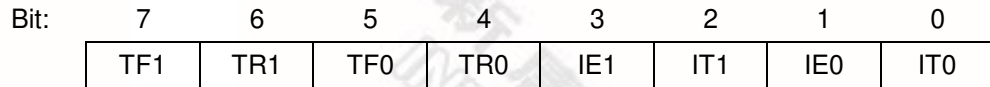

Mnemonic: TCON

Address: 88h

- TF1: Timer 1 overflow flag: This bit is set when Timer 1 overflows. It is cleared automatically when the program does a timer 1 interrupt service routine. Software can also set or clear this bit.
- TR1: Timer 1 run control: This bit is set or cleared by software to turn timer/counter on or off.
- TF0: Timer 0 overflow flag: This bit is set when Timer 0 overflows. It is cleared automatically when the program does a timer 0 interrupt service routine. Software can also set or clear this bit.
- TR0: Timer 0 run control: This bit is set or cleared by software to turn timer/counter on or off.
- IE1: Interrupt 1 edge detect: Set by hardware when an edge/level is detected on $\overline{INT1}$. This bit is cleared by hardware when the service routine is vectored to only if the interrupt was edge triggered. Otherwise it follows the pin.
- IT1: Interrupt 1 type control: Set/cleared by software to specify falling edge/ low level triggered external inputs.
- IE0: Interrupt 0 edge detect: Set by hardware when an edge/level is detected on $\overline{INT0}$. This bit is cleared by hardware when the service routine is vectored to only if the interrupt was edge triggered. Otherwise it follows the pin.
- IT0: Interrupt 0 type control: Set/cleared by software to specify falling edge/ low level triggered external inputs.

TIMER MODE CONTROL

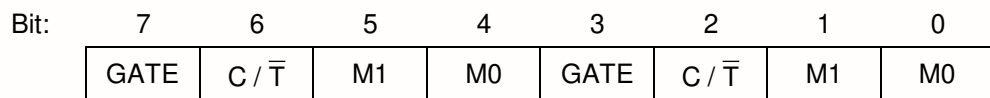

TIMER1

TIMER0

Mnemonic: TMOD

Address: 89h

- GATE: Gating control: When this bit is set, Timer/counter x is enabled only while \overline{INTx} pin is high and TRx control bit is set. When cleared, Timer x is enabled whenever TRx control bit is set.
- C / \overline{T} : Timer or Counter Select: When cleared, the timer is incremented by internal clocks. When set, the timer counts high-to-low edges of the Tx pin.

M1, M0: Mode Select bits:

M1	M0	Mode
0	0	Mode 0: 8-bits with 5-bit prescale.
0	1	Mode 1: 16-bits, no prescale.
1	0	Mode 2: 8-bits with auto-reload from THx
1	1	Mode 3: (Timer 0) TL0 is an 8-bit timer/counter controlled by the standard Timer 0 control bits. TH0 is a 8-bit timer only controlled by Timer 1 control bits. (Timer 1) Timer/counter is stopped.

TIMER 0 LSB

Bit:	7	6	5	4	3	2	1	0
	TL0.7	TL0.6	TL0.5	TL0.4	TL0.3	TL0.2	TL0.1	TL0.0

Mnemonic: TL0

Address: 8Ah

TL0.7-0: Timer 0 LSB

TIMER 1 LSB

Bit:	7	6	5	4	3	2	1	0
	TL1.7	TL1.6	TL1.5	TL1.4	TL1.3	TL1.2	TL1.1	TL1.0

Mnemonic: TL1

Address: 8Bh

TL1.7-0:Timer 1 LSB

TIMER 0 MSB

Bit:	7	6	5	4	3	2	1	0
	TH0.7	TH0.6	TH0.5	TH0.4	TH0.3	TH0.2	TH0.1	TH0.0

Mnemonic: TH0

Address: 8Ch

TH0.7-0: Timer 0 MSB

TIMER 1 MSB

Bit:	7	6	5	4	3	2	1	0
	TH1.7	TH1.6	TH1.5	TH1.4	TH1.3	TH1.2	TH1.1	TH1.0

Mnemonic: TH1

Address: 8Dh

TH1.7-0: Timer 1 MSB

CLOCK CONTROL

Bit:	7	6	5	4	3	2	1	0
	WD1	WD0	T2M	T1M	T0M	MD2	MD1	MD0

Mnemonic: CKCON

Address: 8Eh

WD1-0: Watchdog timer mode select bits: These bits determine the time-out period for the watchdog timer. In all four time-out options the reset time-out is 512 clocks more than the interrupt time-out period.

WD1	WD0	INTERRUPT TIME-OUT	RESET TIME-OUT
0	0	2^{17}	$2^{17} + 512$
0	1	2^{20}	$2^{20} + 512$
1	0	2^{23}	$2^{23} + 512$
1	1	2^{26}	$2^{26} + 512$

T2M: Timer 2 clock select: When T2M is set to 1, timer 2 uses a divide by 4 clock, and when set to 0 it uses a divide by 12 clock.

T1M: Timer 1 clock select: When T1M is set to 1, timer 1 uses a divide by 4 clock, and when set to 0 it uses a divide by 12 clock.

T0M: Timer 0 clock select: When T0M is set to 1, timer 0 uses a divide by 4 clock, and when set to 0 it uses a divide by 12 clock.

MD2-0: Stretch MOVX select bits: These three bits are used to select the stretch value for the MOVX instruction. Using a variable MOVX length enables the user to access slower external memory devices or peripherals without the need for external circuits. The RD or WR strobe will be stretched by the selected interval. When accessing the on-chip SRAM, the MOVX instruction is always in 2 machine cycles regardless of the stretch setting. By default, the stretch has value of 1. If the user needs faster accessing, then a stretch value of 0 should be selected.

MD2	MD1	MD0	Stretch value	MOVX duration
0	0	0	0	2 machine cycles
0	0	1	1	3 machine cycles (<i>Default</i>)
0	1	0	2	4 machine cycles
0	1	1	3	5 machine cycles
1	0	0	4	6 machine cycles
1	0	1	5	7 machine cycles
1	1	0	6	8 machine cycles
1	1	1	7	9 machine cycles

PORT 1

Bit:	7	6	5	4	3	2	1	0
	P1.7	P1.6	P1.5	P1.4	P1.3	P1.2	P1.1	P1.0

Mnemonic: P1

Address: 90h

P1.7-0: General purpose I/O port. Most instructions will read the port pins in case of a port read access, however in case of read-modify-write instructions, the port latch is read. Some pins also have alternate input or output functions. This alternate functions are described below:

P1.0 : T2	External I/O for Timer/Counter 2
P1.1 : T2EX	Timer/Counter 2 Capture/Reload Trigger
P1.2 : RXD1	Serial Port 1 Receive
P1.3 : TXD1	Serial Port 1 Transmit
P1.4 : INT2	External Interrupt 2
P1.5 : $\overline{\text{INT3}}$	External Interrupt 3
P1.6 : INT4	External Interrupt 4
P1.7 : $\overline{\text{INT5}}$	External Interrupt 5

EXTERNAL INTERRUPT FLAG

Bit:	7	6	5	4	3	2	1	0
	IE5	IE4	IE3	IE2	-	-	-	-

Mnemonic: EXIF

Address: 91h

IE5: External Interrupt 5 flag. Set by hardware when a falling edge is detected on $\overline{\text{INT5}}$.

IE4: External Interrupt 4 flag. Set by hardware when a rising edge is detected on INT4.

IE3: External Interrupt 3 flag. Set by hardware when a falling edge is detected on $\overline{\text{INT3}}$.

IE2: External Interrupt 2 flag. Set by hardware when a rising edge is detected on INT2.

PORT 4 CONTROL REGISTER A

Bit:	7	6	5	4	3	2	1	0
	P41M1	P41M0	P41C1	P41C0	P40M1	P40M0	P40C1	P40C0

Mnemonic: P4CONA

Address: 92h

PORT 4 CONTROL REGISTER B

Bit:	7	6	5	4	3	2	1	0
	P43M1	P43M0	P43C1	P43C0	P42M1	P42M0	P42C1	P42C0

Mnemonic: P4CONB

Address: 93h

BIT NAME	FUNCTION
P4xM1, P4xM0	Port 4 alternate modes. =00: Mode 0. P4.x is a general purpose I/O port which is the same as Port 1. =01: Mode 1. P4.x is a Read Strobe signal for chip select purpose. The address range depends on the SFR P4xAH, P4xAL and bits P4xC1, P4xC0. =10: Mode 2. P4.x is a Write Strobe signal for chip select purpose. The address range depends on the SFR P4xAH, P4xAL and bits P4xC1, P4xC0. =11: Mode 3. P4.x is a Read/Write Strobe signal for chip select purpose. The address range depends on the SFR P4xAH, P4xAL and bits P4xC1, P4xC0
P4xC1, P4xC0	Port 4 Chip-select Mode address comparison: =00: Compare the full address (16 bits length) with the base address registers P4xAH and P4xAL. =01: Compare the 15 high bits (A15-A1) of address bus with the base address registers P4xAH and P4xAL. =10: Compare the 14 high bits (A15-A2) of address bus with the base address registers P4xAH and P4xAL. =11: Compare the 8 high bits (A15-A8) of address bus with the base address registers P4xAH and P4xAL.

P4.0 BASE ADDRESS LOW BYTE REGISTER

Bit:	7	6	5	4	3	2	1	0
	A7	A6	A5	A4	A3	A2	A1	A0

Mnemonic: P40AL

Address: 94h

P4.0 BASE ADDRESS HIGH BYTE REGISTER

Bit:	7	6	5	4	3	2	1	0
	A15	A14	A13	A12	A11	A10	A9	A8

Mnemonic: P40AH

Address: 95h

P4.1 BASE ADDRESS LOW BYTE REGISTER

Bit:	7	6	5	4	3	2	1	0
	A7	A6	A5	A4	A3	A2	A1	A0

Mnemonic: P41AL

Address: 96h

P4.1 BASE ADDRESS HIGH BYTE REGISTER

Bit:	7	6	5	4	3	2	1	0
	A15	A14	A13	A12	A11	A10	A9	A8

Mnemonic: P41AH

Address: 97h

SERIAL PORT CONTROL

Bit:	7	6	5	4	3	2	1	0
	SM0/FE	SM1	SM2	REN	TB8	RB8	TI	RI

Mnemonic: SCON

Address: 98h

SM0/FE: Serial port 0, Mode 0 bit or Framing Error Flag: The SMOD0 bit in PCON SFR determines whether this bit acts as SM0 or as FE. The operation of SM0 is described below. When used as FE, this bit will be set to indicate an invalid stop bit. This bit must be manually cleared in software to clear the FE condition.

SM1: Serial port Mode bit 1:

SM0	SM1	Mode	Description	Length	Baud rate
0	0	0	Synchronous	8	4/12 Tclk
0	1	1	Asynchronous	10	Variable
1	0	2	Asynchronous	11	64/32 Tclk
1	1	3	Asynchronous	11	Variable

SM2: Multiple processors communication. Setting this bit to 1 enables the multiprocessor communication feature in mode 2 and 3. In mode 2 or 3, if SM2 is set to 1, then RI will not be activated if the received 9th data bit (RB8) is 0. In mode 1, if SM2 = 1, then RI will not be activated if a valid stop bit was not received. In mode 0, the SM2 bit controls the serial port clock. If set to 0, then the serial port runs at a divide by 12 clock of the oscillator. This gives compatibility with the standard 8052. When set to 1, the serial clock become divide by 4 of the oscillator clock. This results in faster synchronous serial communication.

REN: Receive enable: When set to 1 serial reception is enabled, otherwise reception is disabled.

TB8: This is the 9th bit to be transmitted in modes 2 and 3. This bit is set and cleared by software as desired.

RB8: In modes 2 and 3 this is the received 9th data bit. In mode 1, if SM2 = 0, RB8 is the stop bit that was received. In mode 0 it has no function.

TI: Transmit interrupt flag: This flag is set by hardware at the end of the 8th bit time in mode 0, or at the beginning of the stop bit in all other modes during serial transmission. This bit must be cleared by software.

RI: Receive interrupt flag: This flag is set by hardware at the end of the 8th bit time in mode 0, or halfway through the stop bits time in the other modes during serial reception. However the restrictions of SM2 apply to this bit. This bit can be cleared only by software.

SERIAL DATA BUFFER

Bit:	7	6	5	4	3	2	1	0
	SBUF.7	SBUF.6	SBUF.5	SBUF.4	SBUF.3	SBUF.2	SBUF.1	SBUF.0

Mnemonic: SBUF

Address: 99h

SBUF.7-0: Serial data on the serial port 0 is read from or written to this location. It actually consists of two separate internal 8-bit registers. One is the receive register, and the other is the transmit buffer. Any read access gets data from the receive data buffer, while write access is to the transmit data buffer.

P4.2 BASE ADDRESS LOW BYTE REGISTER

Bit:	7	6	5	4	3	2	1	0
	A7	A6	A5	A4	A3	A2	A1	A0

Mnemonic: P42AL

Address: 9Ah

P4.2 BASE ADDRESS HIGH BYTE REGISTER

Bit:	7	6	5	4	3	2	1	0
	A15	A14	A13	A12	A11	A10	A9	A8

Mnemonic: P42AH

Address: 9Bh

P4.3 BASE ADDRESS LOW BYTE REGISTER

Bit:	7	6	5	4	3	2	1	0
	A7	A6	A5	A4	A3	A2	A1	A0

Mnemonic: P43AL

Address: 9Ch

P4.3 BASE ADDRESS HIGH BYTE REGISTER

Bit:	7	6	5	4	3	2	1	0
	A15	A14	A13	A12	A11	A10	A9	A8

Mnemonic: P43AH

Address: 9Dh

ISP CONTROL REGISTER

Bit:	7	6	5	4	3	2	1	0
	SWRST/HWB	-	LDAP	-	-	-	LDSEL	ENP

Mnemonic: CHPCON

Address: 9Fh

SWRST/HWB: Set this bit to launch a whole device reset that is same as asserting high to RST pin, micro controller will be back to initial state and clear this bit automatically. To read this bit, its alternate function to indicate the ISP hardware reboot mode is invoking when read it in high.

LDAP: This bit is Read Only. High: device is executing the program in LDFLASH. Low: device is executing the program in APFLASHs.

LDSEL: Loader program residence selection. Set to high to route the device fetching code from LDFLASH.

ENP: In System Programming Mode Enable. Set this be to launch the ISP mode. Device will operate ISP procedures, such as Erase, Program and Read operations, according to correlative SFRs settings. During ISP mode, device achieves ISP operations by the way of IDLE state. In the other

words, device is not indeed in IDLE mode is set bit PCON.1 while ISP is enabled. Clear this bit to disable ISP mode, device get back to normal operation including IDLE state.

Software Reset

Set CHPCON = 0X83, timer and enter IDLE mode. CPU will reset and restart from APFLASH after time out.

PORT 2

Bit:	7	6	5	4	3	2	1	0
	P2.7	P2.6	P2.5	P2.4	P2.3	P2.2	P2.1	P2.0

Mnemonic: P2

Address: A0h

P2.7-0: Port 2 is a bi-directional I/O port with internal pull-ups. This port also provides the upper address bits for accesses to external memory.

PORT 4 CHIP-SELECT POLARITY

Bit:	7	6	5	4	3	2	1	0
	P43INV	P42INV	P42INV	P40INV	-	-	-	P0UP

Mnemonic: P4CSIN

Address: A2h

P4xINV: The active polarity of P4.x when set it as chip-select signal. High = Active High. Low = Active Low.

P0UP: Enable Port 0 weak pull up.

PORT 4

Bit:	7	6	5	4	3	2	1	0
	-	-	-	-	P4.3	P4.2	P4.1	P4.0

Mnemonic: P4

Address: A5h

P4.3-0: Port 4 is a bi-directional I/O port with internal pull-ups. Port 4 can not use bit-addressable instruction (SETB or CLR).

INTERRUPT ENABLE

Bit:	7	6	5	4	3	2	1	0
	EA	ES1	ET2	ES	ET1	EX1	ET0	EX0

Mnemonic: IE

Address: A8h

EA: Global enable. Enable/disable all interrupts except for PFI.

ES1: Enable Serial Port 1 interrupt.

ET2: Enable Timer 2 interrupt.

ES: Enable Serial Port 0 interrupt.

ET1: Enable Timer 1 interrupt

EX1: Enable external interrupt 1

ET0: Enable Timer 0 interrupt

EX0: Enable external interrupt 0

SLAVE ADDRESS

Mnemonic: SADDR

Address: A9h

SADDR: The SADDR should be programmed to the given or broadcast address for serial port 0 to which the slave processor is designated.

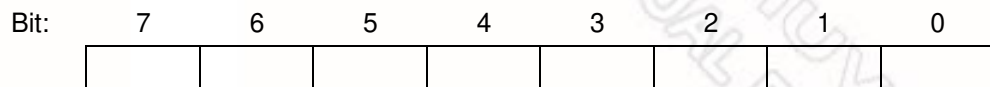
SLAVE ADDRESS 1

Mnemonic: SADDR1

Address: AAh

SADDR1: The SADDR1 should be programmed to the given or broadcast address for serial port 1 to which the slave processor is designated.

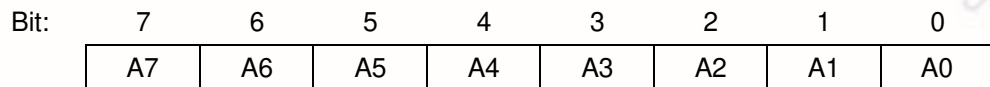
ISP ADDRESS LOW BYTE

Mnemonic: SFRAL

Address: ACh

Low byte destination address for In System Programming operations. SFRAH and SFRAL address a specific ROM bytes for erasure, programming or read.

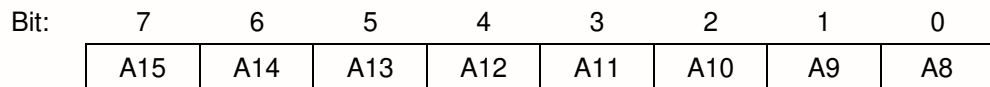
ISP ADDRESS HIGH BYTE

Mnemonic: SFRAH

Address: ADh

High byte destination address for In System Programming operations. SFRAH and SFRAL address a specific ROM bytes for erasure, programming or read.

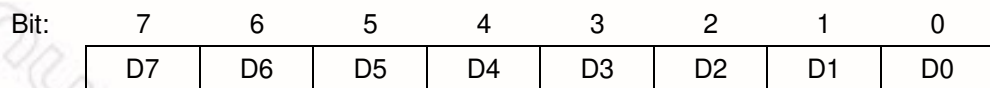
ISP DATA BUFFER

Mnemonic: SFRFD

Address: AEh

In ISP mode, read/write a specific byte ROM content must go through SFRFD register.

ISP OPERATION MODES

Bit:	7	6	5	4	3	2	1	0
	-	WFWIN	NOE	NCE	CTRL3	CTRL2	CTRL1	CTRL0

Mnemonic: SFR CN

Address: AFh

WFWIN: Destination ROM bank for programming, erasure and read. 0 = APFLASH, 1 = LDFLASH.

NOE: Flash EPROM output enable.

NCE: Flash EPROM chip enable.

CTRL[3:0]: Mode Selection.

ISP MODE	WFWIN	NOE	NCE	CTRL<3:0>	SFRAH, SFRAL	SFRFD
Erase 4KB LDFLASH	1	1	0	0010	X	X
Erase 64K APFLASH	0	1	0	0010	X	X
Program 4KB LDFLASH	1	1	0	0001	Address in	Data in
Program 64KB APFLASH	0	1	0	0001	Address in	Data in
Read 4KB LDFLASH	1	0	0	0000	Address in	Data out
Read 64KB APFLASH	0	0	0	0000	Address in	Data out

PORT 3

Bit:	7	6	5	4	3	2	1	0
	P3.7	P3.6	P3.5	P3.4	P3.3	P3.2	P3.1	P3.0

Mnemonic: P3

Address: B0h

P3.7-0: General purpose I/O port. Each pin also has an alternate input or output function. The alternate functions are described below.

P3.7	\overline{RD}	Strobe for read from external RAM
P3.6	\overline{WR}	Strobe for write to external RAM
P3.5	T1	Timer/counter 1 external count input
P3.4	T0	Timer/counter 0 external count input
P3.3	$\overline{INT1}$	External interrupt 1
P3.2	$\overline{INT0}$	External interrupt 0
P3.1	TxD	Serial port 0 output
P3.0	RxD	Serial port 0 input

INTERRUPT PRIORITY

Bit:	7	6	5	4	3	2	1	0
	-	PS1	PT2	PS	PT1	PX1	PT0	PX0

Mnemonic: IP

Address: B8h

IP.7: This bit is un-implemented and will read high.

PS1: This bit defines the Serial port 1 interrupt priority. PS = 1 sets it to higher priority level.

PT2: This bit defines the Timer 2 interrupt priority. PT2 = 1 sets it to higher priority level.

PS: This bit defines the Serial port 0 interrupt priority. PS = 1 sets it to higher priority level.

PT1: This bit defines the Timer 1 interrupt priority. PT1 = 1 sets it to higher priority level.

PX1: This bit defines the External interrupt 1 priority. PX1 = 1 sets it to higher priority level.

PT0: This bit defines the Timer 0 interrupt priority. PT0 = 1 sets it to higher priority level.

PX0: This bit defines the External interrupt 0 priority. PX0 = 1 sets it to higher priority level.

SLAVE ADDRESS MASK ENABLE

Bit:	7	6	5	4	3	2	1	0

Mnemonic: SADEN

Address: B9h

SADEN: This register enables the Automatic Address Recognition feature of the Serial port 0. When a bit in the SADEN is set to 1, the same bit location in SADDR will be compared with the incoming serial data. When SADEN.n is 0, then the bit becomes a "don't care" in the comparison. This register enables the Automatic Address Recognition feature of the Serial port 0. When all the bits of SADEN are 0, interrupt will occur for any incoming address.

SLAVE ADDRESS MASK ENABLE 1

Bit:	7	6	5	4	3	2	1	0

Mnemonic: SADEN1

Address: BAh

SADEN1: This register enables the Automatic Address Recognition feature of the Serial port 1. When a bit in the SADEN1 is set to 1, the same bit location in SADDR1 will be compared with the incoming serial data. When SADEN1.n is 0, then the bit becomes a "don't care" in the comparison. This register enables the Automatic Address Recognition feature of the Serial port 1. When all the bits of SADEN1 are 0, interrupt will occur for any incoming address.

SERIAL PORT CONTROL 1

Bit:	7	6	5	4	3	2	1	0
	SM0_1/FE_1	SM1_1	SM2_1	REN_1	TB8_1	RB8_1	TI_1	RI_1

Mnemonic: SCON1

Address: C0h

SM0_1/FE_1: Serial port 1, Mode 0 bit or Framing Error Flag 1: The SMOD0 bit in PCON SFR determines whether this bit acts as SM0_1 or as FE_1. the operation of SM0_1 is described below. When used as FE_1, this bit will be set to indicate an invalid stop bit. This bit must be manually cleared in software to clear the FE_1 condition.

SM1_1: Serial port 1 Mode bit 1:

SM0_1	SM1_1	Mode	Description	Length	Baud rate
0	0	0	Synchronous	8	4/12 Tclk
0	1	1	Asynchronous	10	variable
1	0	2	Asynchronous	11	64/32 Tclk
1	1	3	Asynchronous	11	variable

SM2_1: Multiple processors communication. Setting this bit to 1 enables the multiprocessor communication feature in mode 2 and 3. In mode 2 or 3, if SM2_1 is set to 1, then RI_1 will not be activated if the received 9th data bit (RB8_1) is 0. In mode 1, if SM2_1 = 1, then RI_1 will not be activated if a valid stop bit was not received. In mode 0, the SM2_1 bit controls the serial port 1 clock. If set to 0, then the serial port 1 runs at a divide by 12 clock of the oscillator. This gives compatibility with the standard 8052. When set to 1, the serial clock become divide by 4 of the oscillator clock. This results in faster synchronous serial communication.

REN_1: Receive enable: When set to 1 serial reception is enabled, otherwise reception is disabled.

TB8_1: This is the 9th bit to be transmitted in modes 2 and 3. This bit is set and cleared by software as desired.

RB8_1: In modes 2 and 3 this is the received 9th data bit. In mode 1, if SM2_1 = 0, RB8_1 is the stop bit that was received. In mode 0 it has no function.

TI_1: Transmit interrupt flag: This flag is set by hardware at the end of the 8th bit time in mode 0, or at the beginning of the stop bit in all other modes during serial transmission. This bit must be cleared by software.

RI_1: Receive interrupt flag: This flag is set by hardware at the end of the 8th bit time in mode 0, or halfway through the stop bits time in the other modes during serial reception. However the restrictions of SM2_1 apply to this bit. This bit can be cleared only by software.

SERIAL DATA BUFFER 1

Bit:	7	6	5	4	3	2	1	0
	SBUF1.7	SBUF1.6	SBUF1.5	SBUF1.4	SBUF1.3	SBUF1.2	SBUF1.1	SBUF1.0

Mnemonic: SBUF1

Address: C1h

SBUF1.7-0: Serial data of the serial port 1 is read from or written to this location. It actually consists of two separate 8-bit registers. One is the receive register, and the other is the transmit buffer. Any read access gets data from the receive data buffer, while write accesses are to the transmit data buffer.

WCON

Bit:	7	6	5	4	3	2	1	0
	WS	-	-	-	-	-	-	-

Mnemonic: WCON

Address: C2h

WS: Wait State Signal Enable. Setting this bit enables the $\overline{\text{WAIT}}$ signal on P4.0. The device will sample the wait state control signal $\overline{\text{WAIT}}$ via P4.0 during MOVX instruction. This bit is time access protected.

TA REG C7H

WCON REG C2H

CKCON REG 8EH

MOV TA, #AAH

MOV TA, #55H

ORL WCON, #1000000B ; Set WS bit and stretch value = 0 to enable wait signal.

POWER MANAGEMENT REGISTER

Bit:	7	6	5	4	3	2	1	0
	CD1	CD0	SWB	-	-	ALE-OFF	-	DME0

Mnemonic: PMR

Address: C4h

CD1, CD0: Clock Divide Control. These bit selects the number of clocks required to generate one machine cycle. There are three modes including divide by 4, 64 or 1024. Switching between modes must first go back divide by 4 mode. For instance, to go from 64 to 1024 clocks/machine cycle the device must first go from 64 to 4 clocks/machine cycle, and then from 4 to 1024 clocks/machine cycle.

CD1,	CD0	CLOCKS/MACHINE CYCLE
0	0	Reserved
0	1	4
1	0	64
1	1	1024