



Chipsmall Limited consists of a professional team with an average of over 10 year of expertise in the distribution of electronic components. Based in Hongkong, we have already established firm and mutual-benefit business relationships with customers from,Europe,America and south Asia,supplying obsolete and hard-to-find components to meet their specific needs.

With the principle of “Quality Parts,Customers Priority,Honest Operation,and Considerate Service”,our business mainly focus on the distribution of electronic components. Line cards we deal with include Microchip,ALPS,ROHM,Xilinx,Pulse,ON,Everlight and Freescale. Main products comprise IC,Modules,Potentiometer,IC Socket,Relay,Connector.Our parts cover such applications as commercial,industrial, and automotives areas.

We are looking forward to setting up business relationship with you and hope to provide you with the best service and solution. Let us make a better world for our industry!



Contact us

Tel: +86-755-8981 8866 Fax: +86-755-8427 6832

Email & Skype: info@chipsmall.com Web: www.chipsmall.com

Address: A1208, Overseas Decoration Building, #122 Zhenhua RD., Futian, Shenzhen, China





 *Kodawari - The Pursuit of Perfection*

WB2F 2D Code Scanner



Small. Flexible. Reliable.

WB2F

IDEC CORPORATION

A top-down view of a white table. In the upper center, a white tablet with a black screen is positioned. To its left, a hand with a grey sleeve is resting on the table. To its right, a hand with a white sleeve is resting on the table. Below the tablet, a hand with a white sleeve is pointing towards the text. In the bottom left corner, there are three rolls of white paper. The word "Solutions" is written in a large, bold, dark grey font, followed by a horizontal line.

Solutions

- Reliable reading of small symbols
- Requires fewer scanners
- Easy setting
- Easily integrated into small devices
- Simplifies external lighting



Flexible setup, mounting, and operation



WB2F



Small and user-friendly



Equipped with a 1.2 megapixel image sensor, the compact WB2F can be installed easily on production lines and in various types of machines.

High-resolution sensor to read small symbols

Reads small symbols in a wide area

WB2F can read micro symbols in a wide area from a distance of 150mm. Wide reading area enables reading of symbols on objects placed irregularly and also the simultaneous reading of multiple symbols.

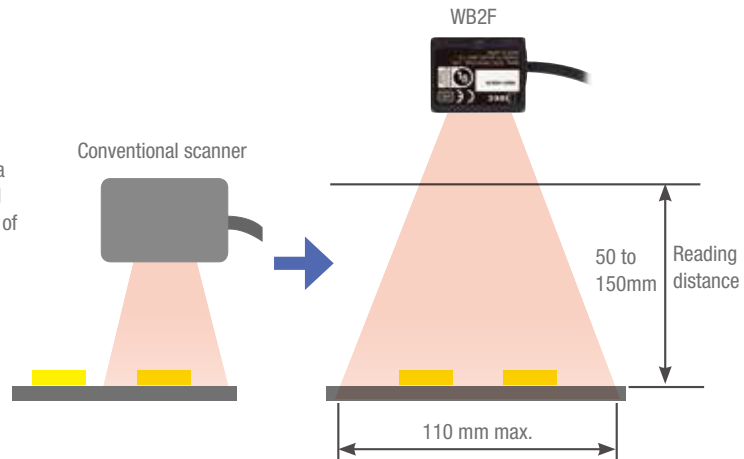

Long reading distance—150 mm max.

Reads symbols at different heights

The deep reading depth range allows for reading symbols at different heights, eliminating the need to adjust the position of WB2F.

* When reading standard barcodes or 2D codes.

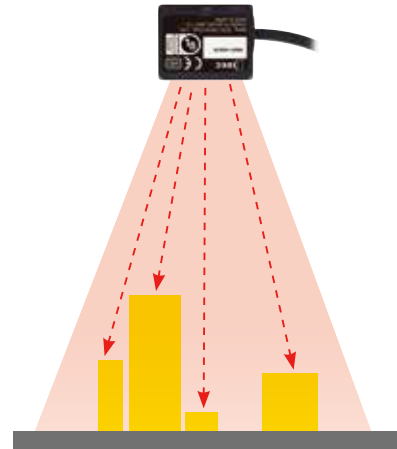

External lighting can be installed easily

External lighting is useful to read DPM (direct parts marking) codes on metal or resin parts. The deep reading depth of WB2F makes it possible to utilize the space between the scanner and objects.

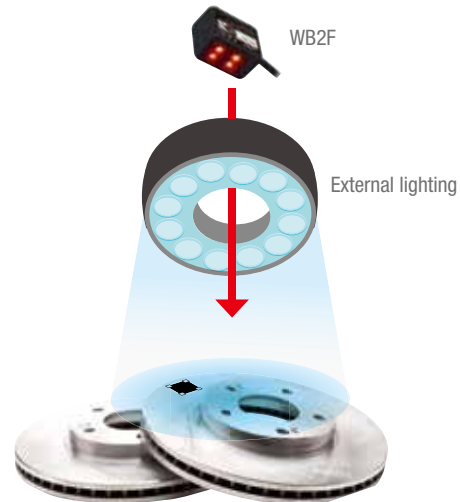

Easy to install



Easy auto-tuning

The best parameters (reading parameter table) for reading symbols, such as lighting and filter conditions, can be tuned automatically.

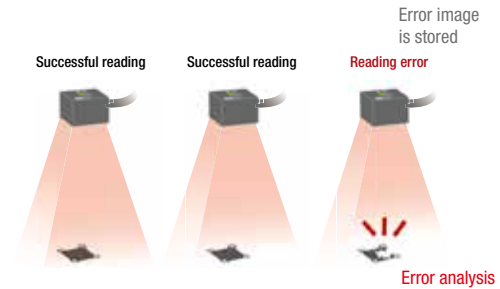

Saves image data at the time of reading failure

Image storage function enables analysis of unreadable images.

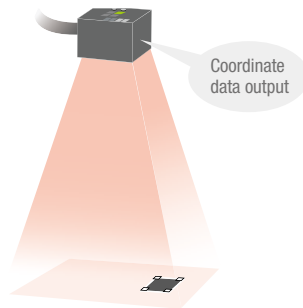

Symbol position measurement

The reading position can be easily set with the output of coordinate data on four corners of the symbol.

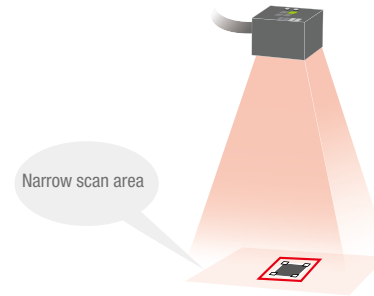

Reading area setup

Setting tool software (*1) helps narrowing the reading area when the symbol location is constant, reducing reading time and stabilizing reading quality.

*1) Setting tool software can be download from IDEC website.

Symbol at the upper
left in the reading area

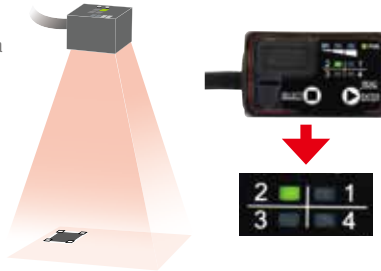

Symbol at the right
in the reading area

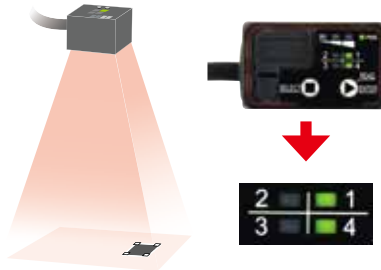

Symbol at the center
in the reading area

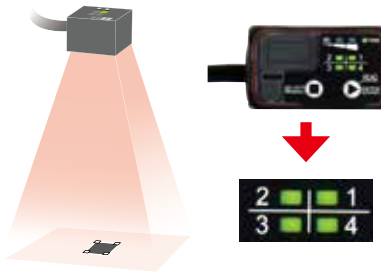

Symbol position display (with LEDs)

Because the symbol location inside the reading area is shown by LEDs, checking on a PC is not necessary.

Interfaces to meet your application

Using WB9Z communication unit (sold separately) enables upper communication via Ethernet.

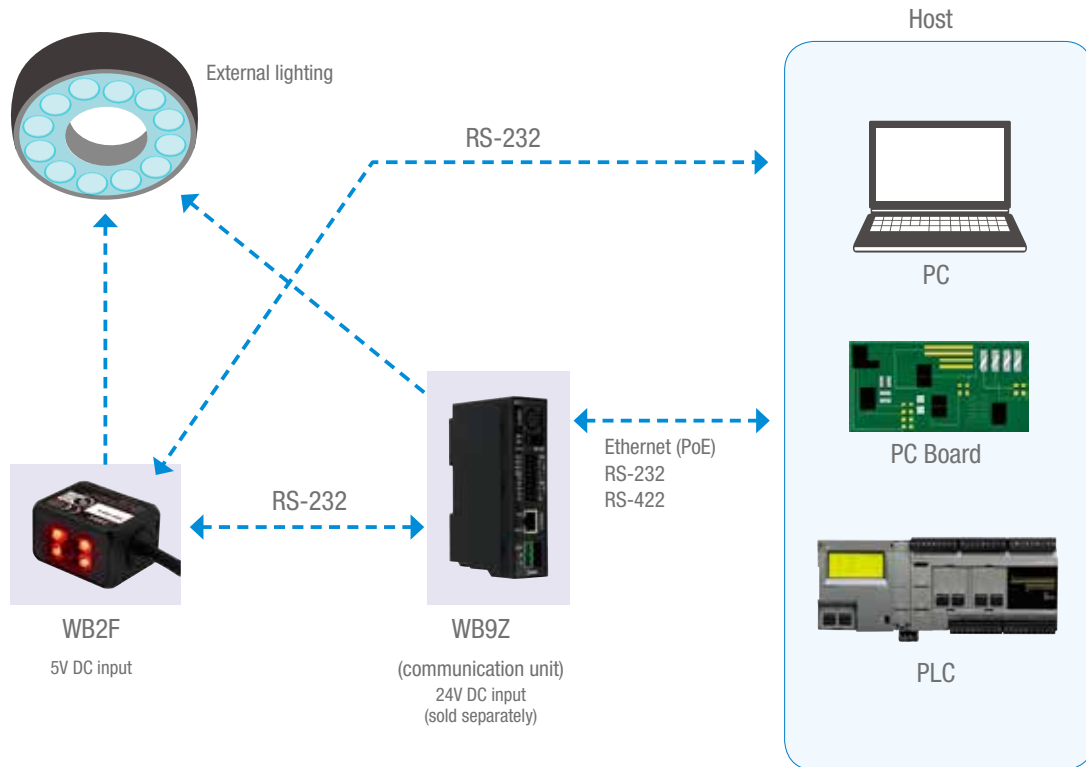



Reads small symbols in a wide area

WB2F is suitable for applications to track various units or important security components.

A wide variety of symbols, such as symbols on PC board/resin, DPM codes on metal, and labels, can be read.

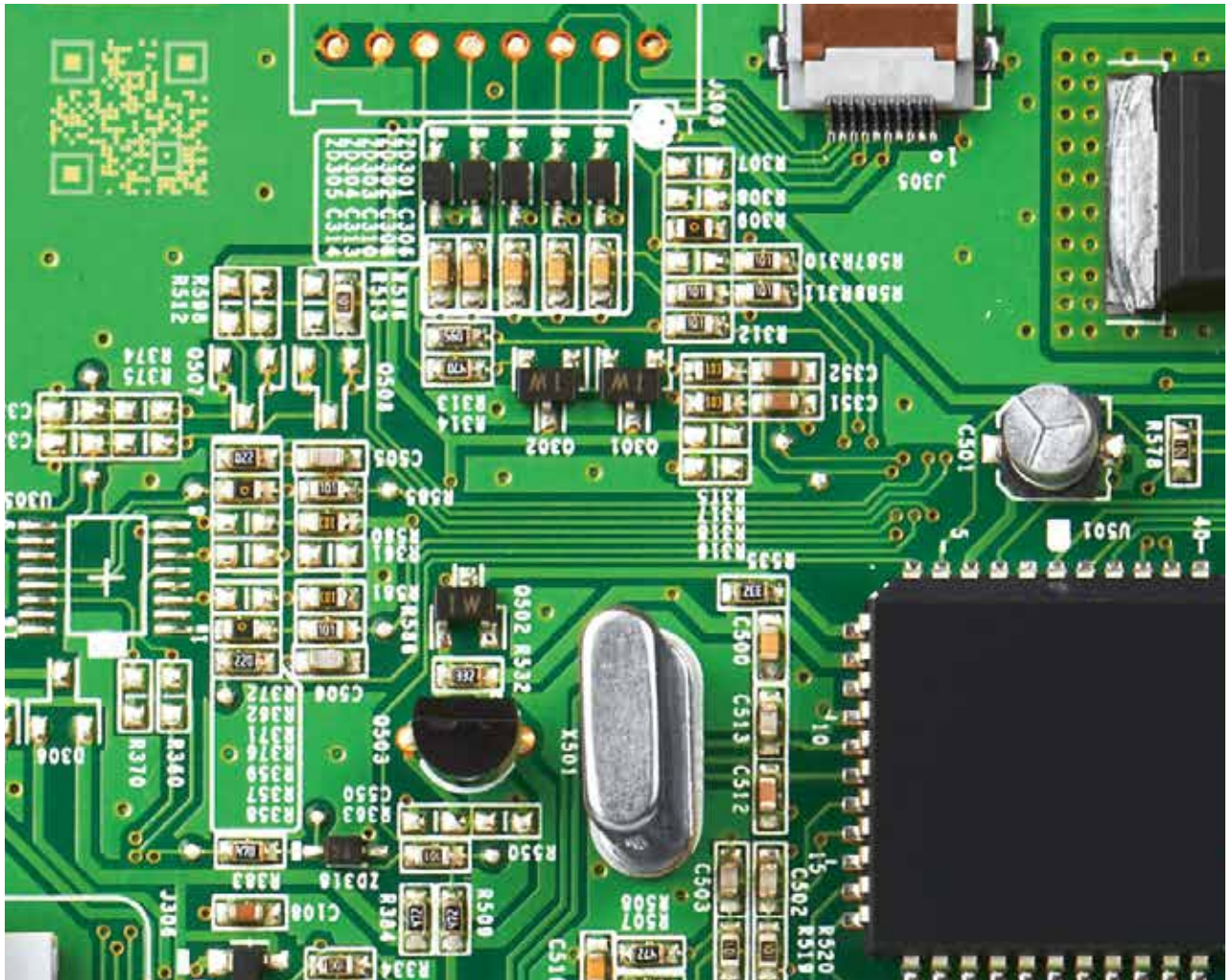

Traceability—electric components

WB2F is well suited for establishing traceability of PC boards with symbols which tend to be small. Symbols can be read with the Scan Area Setup Function, which presets the reading area.



Management and process instruction of carriers, cassettes, and wafers—semiconductor equipment

Compact WB2F can be installed in limited spaces such as load port.

Coordinate output function is useful for detecting the positions of OHT (Overhead Hoist Transfer) and AGV (Automatic Guided Vehicle).



Traceability—electric components of smartphones

WB2F is suited for establishing the traceability of mobile devices such as a tablet, smartphone, camera module, and PC board.



Efficient transportation of small containers—food and medicine

WB2F reads miniature symbols on small containers.

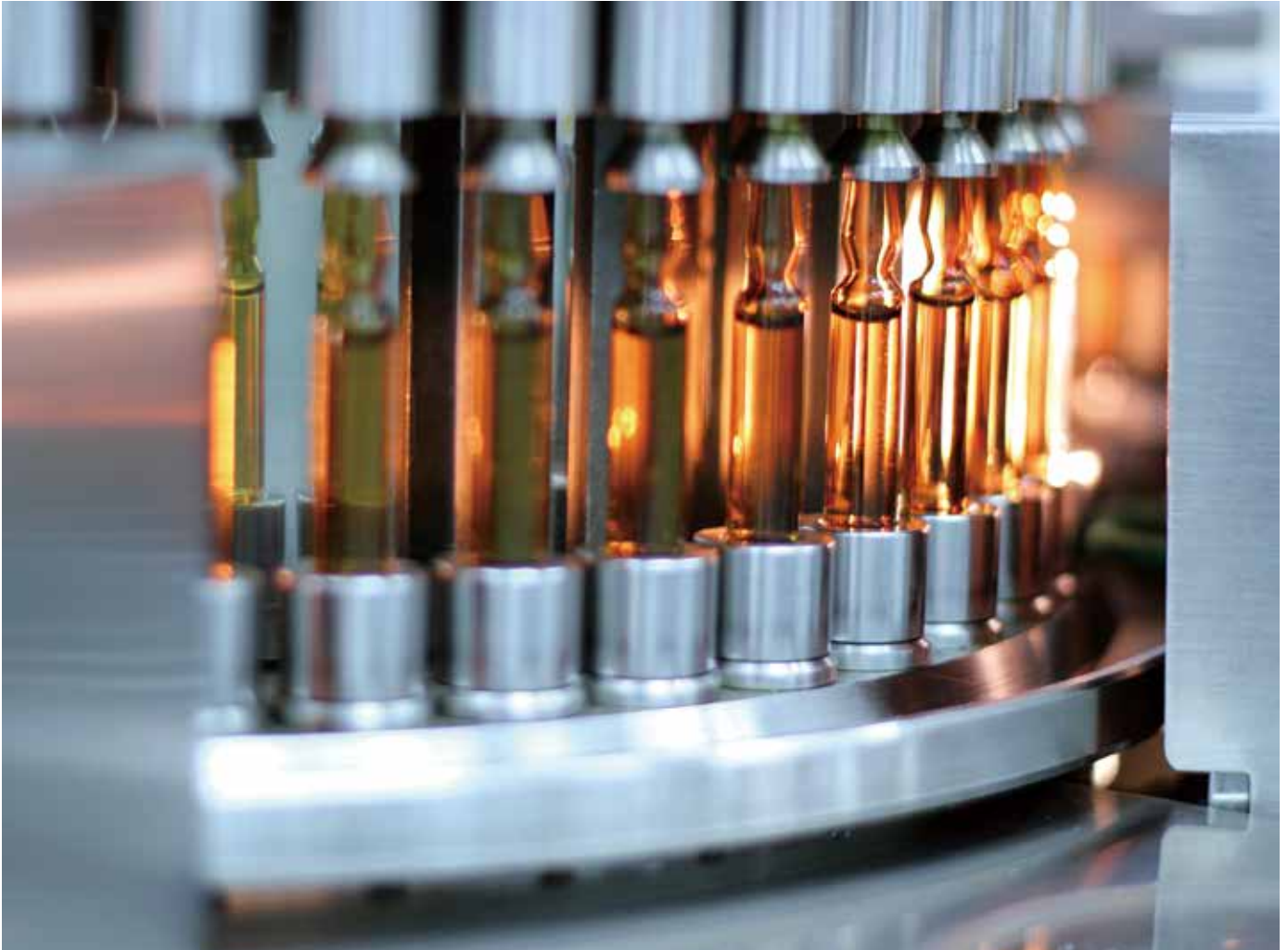

Flexible integration—specimen analysis apparatus

WB2F is the ideal solution for integrating into specimen analysis apparatus for reading symbols.

WB2F 2D Code Scanner Specification/Dimensions

Model No.		WB2F-100S1B
Rated Power Voltage		5V DC \pm 0.25V (*1)
Consumption Current		500mA or less (peak 1A or less)
Operation Button		Two tactile switches equipped
Reading Distance	Barcode	50 to 180mm (narrow bar size 0.5mm) (*2)
	2D code	50 to 150mm (cell size 0.5mm) (*2)
Focal Point		100mm
Field of View		70mm \times 50mm (at focal point)
Number of Digits to be Read	Barcode	64 digits maximum
	2D code	7,089 digits maximum
PCS		0.45 or higher (*2)
Minimum Resolution		0.127mm
Light Source		Red LED
Imaging Element		CMOS image sensor with global shutter
Frame Rate	Quad-VGA (1280 \times 960)	36fps
	720p (1280 \times 720)	40fps
	WVGA (800 \times 480)	60fps
Communication Interface	Serial I/F	RS-232 (600 to 115,200bps) (*3)
	USB	USB2.0 full-speed 12Mbps (virtual COM) (*4)
Connection		13-pin DIN type connector 2m
External Input		2 circuits Non-voltage contact (low active) Voltage input (VIL: 0-1.0V, VIH: 4.0-VCC) (*4)
External Output		4 circuits NPN open collector (sink) Max. rating 26.4V DC, 50mA

Dielectric Strength		500V AC (live part-dead part, 1 minute)
Anti-ESD		Contact \pm 4kV, air \pm 8kV (IEC61000-4-2)
Operating Temperature		0 to +45°C (no freezing)
Operating Humidity		30 to 85% RH (no condensation)
Extraneous Light Immunity		Under sunlight: 10,000 lx maximum Under incandescent light: 6,000 lx maximum Under fluorescent light: 2,000 lx maximum
Storage Temperature		-20 to +60°C (no freezing)
Weight		Approx. 150g
Degree of Protection		IP65
Applicable Standards		UL/c-UL Listing, CE marking, VCCI (report of compliance), FCC (verified), ICES-003
Symbols to be read	Barcode	EAN-13/8 (including add-on), UPC-A/E0/E1, (including add-on), CODE39, Codabar (=NW7), Interleaved 2of5 (=ITF), Standard 2of5 (=Industrial 2of5), Matrix 2of5, Chinese Post Matrix, C0OP 2of5, SCODE, Code93, Code128, GS1-128 (formerly EAN-128), MSI/Plessey, Italian Pharmacy (=Code32), CIP39, Tri-Optic, TELEPEN, Code11, GS1 Databar (formerly RSS) (Omni-directional, Truncated, Limitrd, Expanded), IATA 2of5
	2D code	QR Code/GS1 QR Code, Micro QR Code, DataMatrix (Data Code)/GS1 DataMatrix, PDF417, Micro PDF417, GS1 composite (CC-A, CC-B, CC-C), Japan Postal

*1: When using WB2F as UL listed product, use limited power source of 5V rated output voltage or NEC Class 2 power source for external power.

*2: When using 1D standard barcodes or 2D codes.

*3: RS-232 factory setting is baud rate 9,600 bps, data size 8 bit, 1 stop bit, even parity bit, no flow control.

*4: For maintenance interface (USB bus power incompatible)

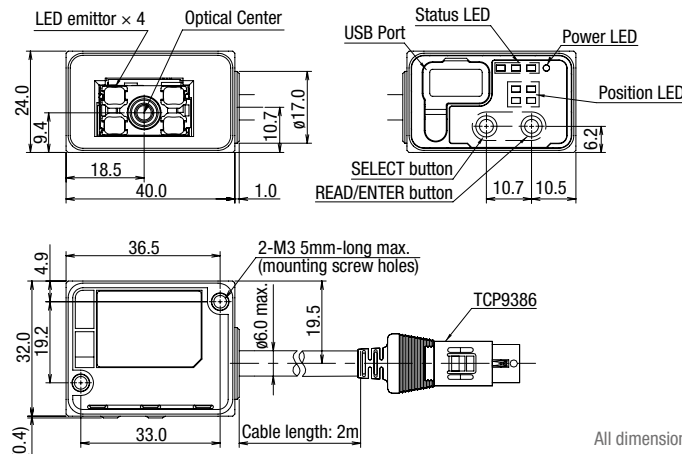

All dimensions in mm.

WB2F 2D Code Scanner Wiring/Terminal Arrangement

Input/output circuit connection example

External output (OUT0 to 3)

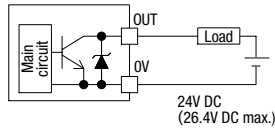

External input (INO, 1)

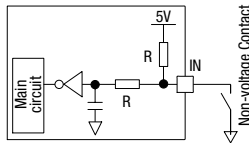

Connector terminal arrangement

DIN connector

Pin No.	Signal	Function
1	OUT0	External output 0
2	OUT1	External output 1
3	OUT2	External output 2
4	OUT3	External output 3
5	+5V	DC power supply +
6	TXD	RS-232 transmission data
7	INO	External input 0
8	IN1	External input 1
9	0V	Power supply - (combined SG)
10	RXD	RS-232 receive data
11	CTS	RS-232 control signal
12	RTS	RS-232 control signal
13	NC	No connection

USB connector (Mini-B)

Pin No.	Signal	Function
1	VBUS	Bus power
2	D-	Data -
3	D+	Data +
4	NC	No connection
5	GND	Ground

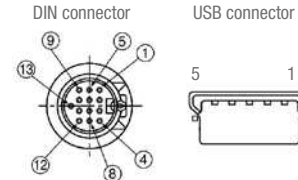

- USB connector is used for maintenance purpose only. When extending a cable using DIN connector, use AWG28 or thicker cable by taking the drop of power supply voltage into consideration. Note that the total cable length over 2.8 m may affect noise resistance.
- When noisy environment affects communication, connect the cable shield to the ground or 0V.

Communication Unit (option) Specifications/Dimensions

Model No.		WB9Z-CU100
Ratings	Power Voltage (*1)	External power supply: 24V DC +10%, -20% (including ripple), or PoE (Alternative A/B) (*2)
	Consumption Current	700mA maximum
Interface	Scanner Interface	RS-232 (600-115,200bps) (*3)
	LAN Interface (*5)	IEEE802.3 compliant (*4), 10BASE-T/100BASE-TX supported protocol: TCP/IP (server), maximum distance: 100m (use shielded cable for over 30m)
	Terminal Block	RS-232 (600-115,200bps) (*4) RS-422 (2 types total) (600-115,200bps) (*4) Maximum distance: 500m (*6)
	USB Interface (for maintenance only)	USB2.0 (Full-speed), 12Mbps (virtual COM)
Input Characteristics	No. of Inputs	2 (IN_0, 1)
	Input Style	Bidirectional voltage input
	Rated Voltage	24V DC (28.8V DC max.)
	Minimum ON Voltage	15V DC
Output Characteristics	Maximum OFF Current	1.3mA
	No. of Outputs	4 (OUT_0-3)
	Output Style	Photo MOS Relay
	Rated Load	24V DC (30V DC max., 100mA max.)
Environment Resistance	Leakage Current at OFF	0.1mA max.
	Residual Voltage at ON	1V max.
Weight (approx.)	Operating Temperature	0 to +50°C (no freezing)
	Storage Temperature	-20°C to +60°C (no freezing)
	Operating Humidity	30 to 85%RH (no condensation)
	Vibration Resistance	10 to 55Hz, amplitude 0.3mm p-p
Degree of Protection	IP20	
Applicable Standards	UL/c-UL Listing (*1), FCC (verified), ICES-003, CE marking, VCCI (report of compliance)	
IDECC Scanner Power Supply	5V DC	

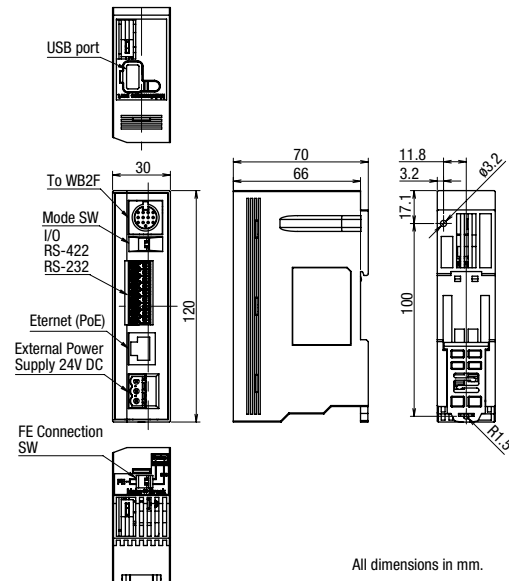

- All dimensions in mm.
- *1: When using WB9Z-CU100 as UL listed product, use limited power source or Class 2 power source for external power.
 - *2: Because power consumption varies depending on the connected scanner, PoE is set at "Class0" at factory.
 - *3: RS-232 factory setting is baud rate 9,600 bps, data size 8 bit, 1 stop bit, even parity bit, no flow control.
 - *4: Ethernet/RS-232/RS-422 are mutually exclusive, and only one type can be used at one time.
 - *5: Factory setting: port number 3000, IP address: 192.168.1.100, subnet mask 255.255.255.0
 - *6: When using a cable longer than 30m, use a shielded cable and connect the shield to F.E.



Safety Precautions

Improper use of this product may cause serious injury or death.

Improper use of this product may cause injury or physical damage.

- Do not use WB2F in medical equipment, nuclear power, railways, aircraft, passenger vehicle equipment, or other applications requiring a high degree of reliability and safety, as WB2F is not designed for these applications.
- When using WB2F in management system of chemicals or other applications with serious impact on human lives, take the utmost care with a redundant design and safety design, so that human lives are not threatened in the event incorrect data is used.
- Do not modify, disassemble, repair WB2F, otherwise serious accidents such as electric shock, damage, fire, or malfunction may result.
- If using WB2F as a part of electrical facilities for general use or connecting WB2F to such parts, use a 3rd party tested power supply. Do not use built-in power supply when not integrating WB2F into equipment, otherwise fire or electric shocks may result.
- Do not look directly at the reading window (transparent part) while LEDs are on (reading codes). Also do not project the light at others, otherwise eyes may be injured.
- WB2F is a general-purpose industrial electric device. Do not use the scanner for electric equipment which may damage the human body or threaten life in case malfunction or failure occurs.
- Power off before wiring or maintenance, otherwise electric shocks or failure will result.
- Do not connect WB2F to the power supply outside the rated voltage, or to an AC power supply. Otherwise electric shocks or failure will result.
- Wire the input and output circuits by referring to “input/output circuit connection example” shown on page 16. WB2F is not equipped with reverse connection circuitry of power supply. Pay extra attention to avoid the reverse connection of power supply, otherwise damage may be caused.
- Avoid parallel wiring of WB2F's wires in the same conduit or duct with high voltage lines or power lines (in particular the inverter power lines). Inductive noise may cause malfunction or damage.
- Single wiring must be adopted in principle when the wires are long or when WB2F may be affected by power sources or electromagnetic devices.
- Do not install WB2F in the following locations subject to:
 - Induction devices or heat sources
 - Severe vibrations or shocks
 - Severe dust
 - Water, oil, or chemicals
 - Outdoors
- WB2F is not explosion-proof. Before installation, make sure that the application does not require explosion protection performance.

Instructions

- Power reset time is 5 seconds approximately. Start operating 5 seconds after powering up.
- When the load and WB2F are connected to different power supplies, make sure to turn on the power supply of WB2F first.
- When installing, avoid direct sunlight or fluorescent light on WB2F.

Cleaning the reading window

Dust, dirt, water droplets, or blemish on the reading window (transparent area) may degrade the reading performance. Periodically check the reading window and clean if necessary.

- To clean, blow off dust with airbrush and clean gently using soft material such as a cotton swab.
- Wipe away water using soft cloth. Do not use any chemical, otherwise the optical part material may be affected.

Cleaning the scanner unit

Clean the scanner unit using a soft dry cloth.

- Do not use chemicals, otherwise the housing quality may be deteriorated, and the paint may come off.
- Use neutral detergent diluted with water to wipe off severe blemish using cloth wrung out of neutral detergent diluted with water, and rewipe with a dry soft cloth.

Mounting

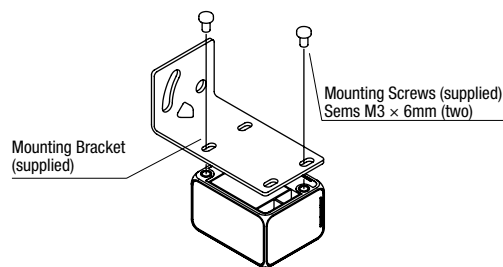

- Tighten the mounting screws to a torque of 0.4 to 0.5 N-m.
- Do not tighten the mounting screws excessively. Do not hit WB2F with a hammer, or apply excessive force on the root of the cable by pulling or bending the cable forcefully, otherwise the degree of protection cannot be maintained.
- Do not use the mounting screws supplied with WB2F when installing on a panel of 2.3 mm or thicker.
- Maintain 3 to 5 mm of penetration depth.

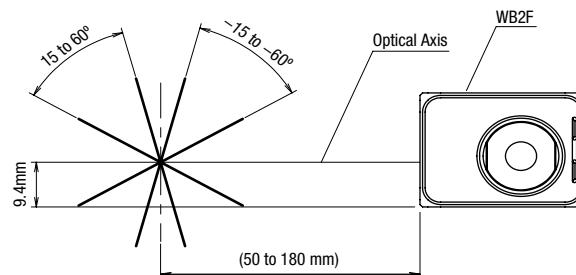

- When installing with a mounting bracket other than supplied with WB2F, the mounting hole diameter must be 3.4 mm maximum.
- Install WB2F in the position where the skew angle of barcodes and 2D codes are within the range shown below. Reading performance deteriorates extremely if the codes meet face-to-face with the optical axis.



IDEC scanners for a wide range of applications

Shape			
Name		Fixed Linear CCD Scanner	Fixed 2D Code Scanner
Model No.		WB1F	WB2F
Features		Smallest in its class. Wide viewing angle. Best choice for integrating into devices.	Small yet high-resolution reading of long distance. High definition CMOS sensor embedded.
1D		√	√
2D		–	√
Size		50 × 20 × 20 mm	24 × 32 × 40 mm
Minimum Resolution		0.127 mm	Barcode: 0.127 mm 2D code: 0.127 mm
Reading Area (Reading Distance)		80 mm (distance 35 mm)	70 × 50 mm (distance 100 mm)
Reading Distance		Barcode Narrow bar width 0.127 mm (30 to 40 mm) 0.19 mm (25 to 45 mm)	Barcode Narrow bar width 0.5 mm (50 to 180 mm) 2D code Cell size 0.5 mm (50 to 150 mm)
Industry	Automobile	√	√
	Material Handling	√	√
	Food	√	√
	Electronics	√	√
	Semiconductor	–	√
	Medical	√	√
	Kiosk/ticketing/labelling terminal	√	√
Degree of Protection		IP40	IP65



IDEC CORPORATION

 www.idec.com

Head Office

6-64, Nishi-Miyahara-2-Chome, Yodogawa-ku, Osaka 532-0004, Japan

USA	IDEC Corporation	Tel: +1-408-747-0550	opencontact@idec.com	Hong Kong	IDEC Izumi (H.K.) Co., Ltd.	Tel: +852-2803-8989	info@hk.idec.com
Australia	IDEC Australia Pty. Ltd.	Tel: +61-3-8523-5900	sales@au.idec.com	China/Shanghai	IDEC (Shanghai) Corporation	Tel: +86-21-6135-1515	idec@cn.idec.com
Germany	IDEC Electrotechnik GmbH	Tel: +49-40-25 30 54 - 0	service@eu.idec.com	China/Shenzhen	IDEC (Shenzhen) Corporation	Tel: +86-755-8356-2977	idec@cn.idec.com
Singapore	IDEC Izumi Asia Pte. Ltd.	Tel: +65-6746-1155	info@sg.idec.com	China/Beijing	IDEC (Beijing) Corporation	Tel: +86-10-6581-6131	idec@cn.idec.com
Thailand	IDEC Asia (Thailand) Co., Ltd	Tel: +66-2-392-9765	sales@th.idec.com	Japan	IDEC Corporation	Tel: +81-6-6398-2527	marketing@idec.co.jp
Taiwan	IDEC Taiwan Corporation	Tel: +886-2-2698-3929	service@tw.idec.com				

Specifications and other descriptions in this brochure are subject to change without notice.
2017 IDEC Corporation, All Rights Reserved.

EP1625-0 MARCH 2017

