



Chipsmall Limited consists of a professional team with an average of over 10 year of expertise in the distribution of electronic components. Based in Hongkong, we have already established firm and mutual-benefit business relationships with customers from,Europe,America and south Asia,supplying obsolete and hard-to-find components to meet their specific needs.

With the principle of “Quality Parts,Customers Priority,Honest Operation,and Considerate Service”,our business mainly focus on the distribution of electronic components. Line cards we deal with include Microchip,ALPS,ROHM,Xilinx,Pulse,ON,Everlight and Freescale. Main products comprise IC,Modules,Potentiometer,IC Socket,Relay,Connector.Our parts cover such applications as commercial,industrial, and automotives areas.

We are looking forward to setting up business relationship with you and hope to provide you with the best service and solution. Let us make a better world for our industry!



## Contact us

Tel: +86-755-8981 8866 Fax: +86-755-8427 6832

Email & Skype: info@chipsmall.com Web: www.chipsmall.com

Address: A1208, Overseas Decoration Building, #122 Zhenhua RD., Futian, Shenzhen, China



### WDU12-1200

#### Electrical Specifications (@25C)

1. Primary Rating: 120V 60Hz 23.5W
2. Primary Excitation Current: 70mA Max
3. Secondary Rating: 12VDC  $\pm$  5%, 1200mADC
4. Secondary No-Load Rating: 16.46VDC Ref.
5. Output Ripple Voltage: 1100mV Max
6. Operating Temperature Range: -10 Deg C to +40 Deg C
7. Temperature Rise: 75 Deg C Max at rated load  
50 Deg C Max on enclosure surface

#### Mechanical Parameters:

Case Type: Thermoplastic molded enclosure.  
Output Cord: 24 AWG, 6 Ft. Long Min.

Agency File:

UL/CUL: File E245587, UL 1310

#### A. Dimensions:

H	W	D
80	60	48

\*Units: In Millimeter

#### B. Schematic:

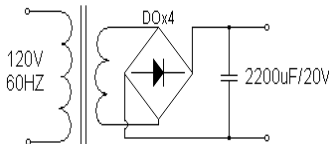

Technical Note: 1. Inside (tip)-positive (+), outside-negative (-)

**U.S. DOE Compliance per Sec. 301 of EISA 2007:** As of July 1, 2008, this product is intended for use as follows:

1. Requires Federal Food and Drug Administration listing and approval as a medical device in accordance with section 513 of the Federal Food, Drug, and Cosmetic Act (21 U.S.C. 360c)
2. Powers the charger of a detachable battery pack or charges the battery of a product that is fully or primarily motor operated.
3. As a service part or a spare part for an end-use product manufactured before July 1, 2008, that constitutes the primary load of this power supply.

**RoHS Compliance:** As of manufacturing date February 2005, all standard products meet the requirements of 2011/65/EU, known as the RoHS initiative.

\* Upon printing, this document is considered "uncontrolled". Please contact Triad Magnetics' website for the most current version.

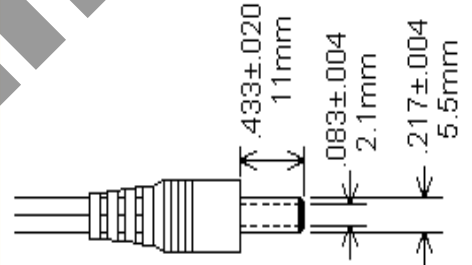
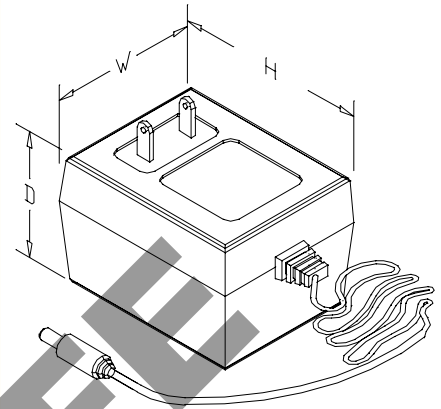

#### NAMEPLATE MARKING

