



Chipsmall Limited consists of a professional team with an average of over 10 year of expertise in the distribution of electronic components. Based in Hongkong, we have already established firm and mutual-benefit business relationships with customers from,Europe,America and south Asia,supplying obsolete and hard-to-find components to meet their specific needs.

With the principle of “Quality Parts,Customers Priority,Honest Operation,and Considerate Service”,our business mainly focus on the distribution of electronic components. Line cards we deal with include Microchip,ALPS,ROHM,Xilinx,Pulse,ON,Everlight and Freescale. Main products comprise IC,Modules,Potentiometer,IC Socket,Relay,Connector.Our parts cover such applications as commercial,industrial, and automotives areas.

We are looking forward to setting up business relationship with you and hope to provide you with the best service and solution. Let us make a better world for our industry!



Contact us

Tel: +86-755-8981 8866 Fax: +86-755-8427 6832

Email & Skype: info@chipsmall.com Web: www.chipsmall.com

Address: A1208, Overseas Decoration Building, #122 Zhenhua RD., Futian, Shenzhen, China



THIS COPY IS PROVIDED ON A RESTRICTED BASIS AND IS NOT TO BE USED IN ANY WAY DETRIMENTAL TO THE INTERESTS OF PANDUIT CORP.

PANDUIT PART NUMBER	WEIGHT
 WG24FRTB**	5.07 LBS/EACH (2299.7 g/EACH)

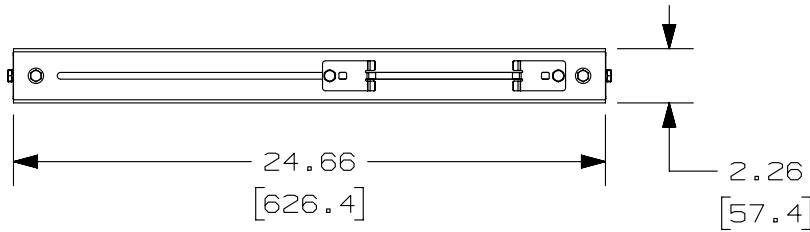

- NOTE:**
- PANDUIT PART NUMBER WG24FRTB** INCLUDES:
 - ONE (1) WYR-GRID 24" WIDTH FIBERRUNNER TRAPEZE BRACKET ASSEMBLY FOR 4X4 AND 6X4.
 - TWO (2) WYR-GRID FIBERRUNNER TRAPEZE UPRIGHT SUPPORT BRACKET ASSEMBLIES.
 - TWO (2) 1/4-20 X 3/4 HEX HEAD CAP SCREWS.
 - FOUR (4) 1/4 -20 HELICAL SPRING LOCKWASHERS.
 - TWO (2) 1/4-20 SAE FLAT WASHER.
 - TWO (2) 1/4-20 X 1-1/8 HEX HEAD CAP SCREWS.
 - TWO (2) WYR-GRID INTEGRAL BRACKET LOWER CLIP ASSEMBLIES.
 - DIMENSIONS IN PARENTHESES ARE METRIC.
 - PROVIDES ABILITY TO MOUNT FIBERRUNNER 6.6" TO 9.9" ABOVE WYR-GRID.
 - SEE CATALOG FOR ADDITIONAL PART SUFFIXES TO INDICATE PART FINISH AND/OR PACKAGE QUANTITY.

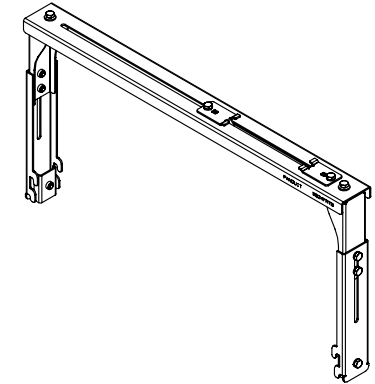
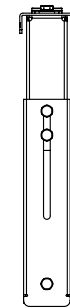
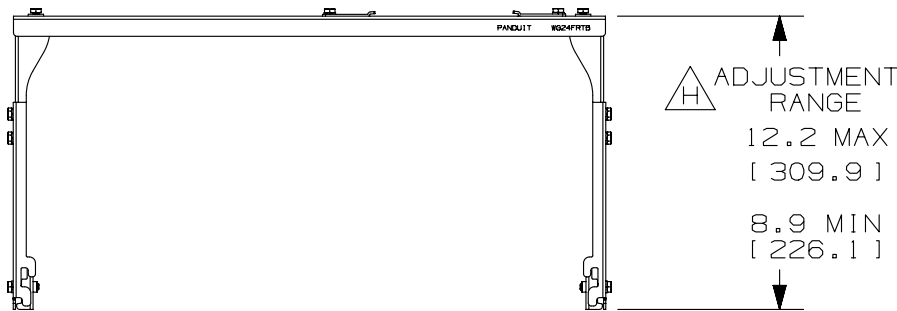

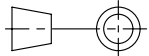

REV	DATE	BY	CHK	APR	DESCRIPTION	ECN
4	09-06-13	SSP	KMC	RN	I. REVISED INTEFRAL TO INTEGRAL ON NOTE 1.G	10D166AH-DC
3	04-05-13	SSP	DWR	RN	RELEASED TO PRODUCTION H. REVISED THE ADJUSTMENT RANGE TOLERANCES G. ADDED '**' SUFFIX TO PANDUIT PART NUMBER F. ADDED NOTE #4 TO GENERAL NOTES E. REMOVED PRIOR NOTE(S)	10D166AH-DC

TITLE						
WYR-GRID 24" WIDTH FIBERRUNNER TRAPEZE BRACKET FOR 4X4 AND 6X4 (WG24FRTB**) 						
CUSTOMER DRAWING						
ITEM REVISION NAME						
10D166AH/03.PRT						
DATASET FILE NAME						
10D166AH_DC/03E WG24FRTB**.PRT						
UNLESS OTHERWISE SPECIFIED, DIMENSIONAL TOLERANCES ARE: IN [mm]						
.X ±		.XXX ±		THIRD ANGLE PROJECTION		
.XX ± .05 [1.3]		ANGLES ±		DRAWING NUMBER:		
				10D166AH-DC		
DRAWN BY	DATE	CHK	SCALE	SHT 1 OF 1		SIZE
ERK	06-17-11	DWR	NONE			A

D10100DA/11