



Chipsmall Limited consists of a professional team with an average of over 10 year of expertise in the distribution of electronic components. Based in Hongkong, we have already established firm and mutual-benefit business relationships with customers from,Europe,America and south Asia,supplying obsolete and hard-to-find components to meet their specific needs.

With the principle of “Quality Parts,Customers Priority,Honest Operation,and Considerate Service”,our business mainly focus on the distribution of electronic components. Line cards we deal with include Microchip,ALPS,ROHM,Xilinx,Pulse,ON,Everlight and Freescale. Main products comprise IC,Modules,Potentiometer,IC Socket,Relay,Connector.Our parts cover such applications as commercial,industrial, and automotives areas.

We are looking forward to setting up business relationship with you and hope to provide you with the best service and solution. Let us make a better world for our industry!



## Contact us

Tel: +86-755-8981 8866 Fax: +86-755-8427 6832

Email & Skype: info@chipsmall.com Web: www.chipsmall.com

Address: A1208, Overseas Decoration Building, #122 Zhenhua RD., Futian, Shenzhen, China



## Wirewound High Surge Resistors

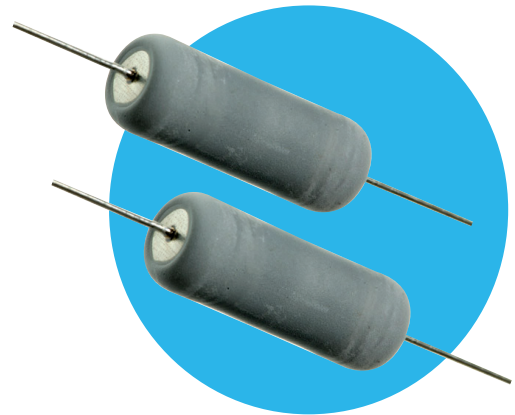

### WHS Series

- Enhanced surge & pulse energy capacity
- UL94-V0 flameproof protection
- Radial taped form available
- Surface mount ZI-form option
- Non inductive type available

All Pb-free parts comply with EU Directive 2011/65/EU amended by (EU) 2015/863 (RoHS3)

### Electrical Data

		WHS2 / WHSP2R	WHS3	WHS5	WHS7	WHS10	WHS10N*
Power rating at 25°C	watts	2	3	5	7	10	
5s overload rating at 25°C	watts	10	15	25	35	50	
Short pulse performance		See Pulse Performance graphs					
Resistance range	ohms	1R0-330R			2R2-330R		5R6-100R
TCR	ppm/°C	±200					
Isolation Voltage	volts	250	350	500	700	1000	
Resistance Tolerance	%	<20R: 5 ≥20R: 1, 2, 5					5%
Standard Values		E24 preferred					
Thermal Impedance	°C/watt	110	82	54	35	25	
Ambient temperature range	°C	-55 to +155					

No Limiting Element Voltage applies to this series; the Rated Voltage is V(P.R).

\*Non inductive (Ayrton Perry) winding

### Physical Data

Dimensions (mm) & Weight (g)							
Type	L max	D max	f min	d max	PCB mount centres	Min bend radius	Wt. nom
WHS2	9.0	3.6	19.80	0.81	12.70	1.2	0.50
WHS3	14.5	5.2	24.55		20.30		1.10
WHS5	16.5	7.0	23.55		22.86		1.75
WHS7	25.0	8.8	28.30		31.40		4.40
WHS10	51.0	10.5	26.00	1.01	55.88	1.5	8.80
WHS10N		11.0					10.50

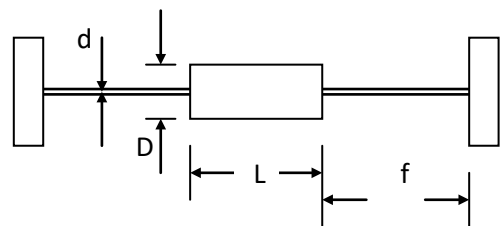

### Construction

A high purity ceramic substrate is assembled with interference fit end caps to which are welded the terminations. The resistive element is wound on the substrate and welded to the caps. Flameproof silicone cement coating is applied prior to marking with indelible ink. The components are then leadformed if required and packed.

### General Note

TT Electronics reserves the right to make changes in product specification without notice or liability. All information is subject to TT Electronics' own data and is considered accurate at time of going to print.

**WHS Series**

**Terminations**

Material: Hot tin dipped copper wire  
 Strength: The terminations meet the requirements of IEC 68.2.21  
 Solderability: The terminations meet the requirements of IEC 115-1 Clause 4.17.3.2

**Marking**

WHS2, WHSP2R and WHS3 resistors are marked with four colour bands in conformance with IEC62. The larger sizes are legend marked with type reference, resistance value and tolerance.

**Solvent Resistance**

The body protection and marking are resistant to all normal industrial cleaning solvents suitable for printed circuits.

**Flammability**

The resistor coating will not burn or emit incandescent particles under any condition of applied temperature or power overload.

**Performance Data**

		Maximum	Typical
Load at rated power: 1000hrs @ 25°C	ΔR%	5 +0.001Ω	3
Dry heat: 1000hrs @ 200°C	ΔR%	5 +0.001Ω	3
Short term overload	ΔR%	5 +0.001Ω	1
Derating from rated power @25°C		Zero at 280°C (See Thermal Performance graph).	
Climatic	ΔR%	5 +0.001Ω	2
Climatic category		55/200/56	
TRC & Vibration	ΔR%	5 +0.001Ω	1
Robustness & solder heat	ΔR%	5 +0.001Ω	1
Long term damp heat (56 days)	ΔR%	5 +0.001Ω	1

**Pulse Performance**

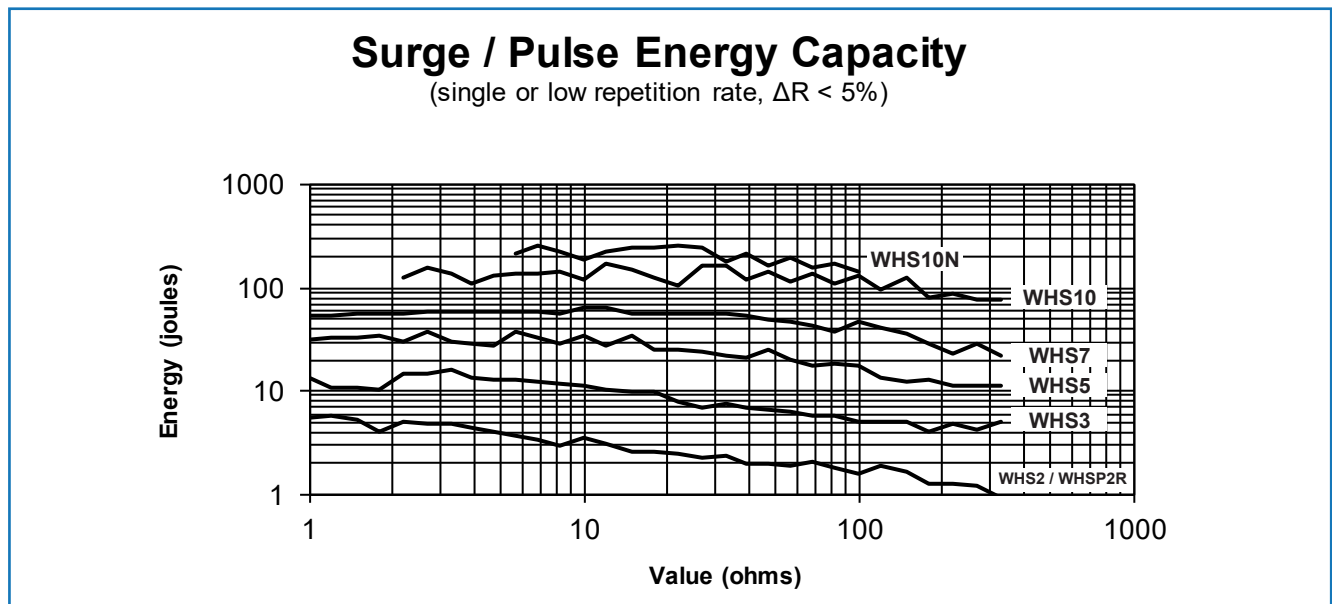

**General Note**

TT Electronics reserves the right to make changes in product specification without notice or liability. All information is subject to TT Electronics' own data and is considered accurate at time of going to print.



WHS Series

### 1.2/50µs Peak Voltage Limit

(10 pulses at 30s intervals,  $\Delta R < 5\%$ )

Note the voltage shown is the nett voltage across the resistor. At low values, the generator open circuit voltage will be higher due to the generator's 2 ohm internal impedance.

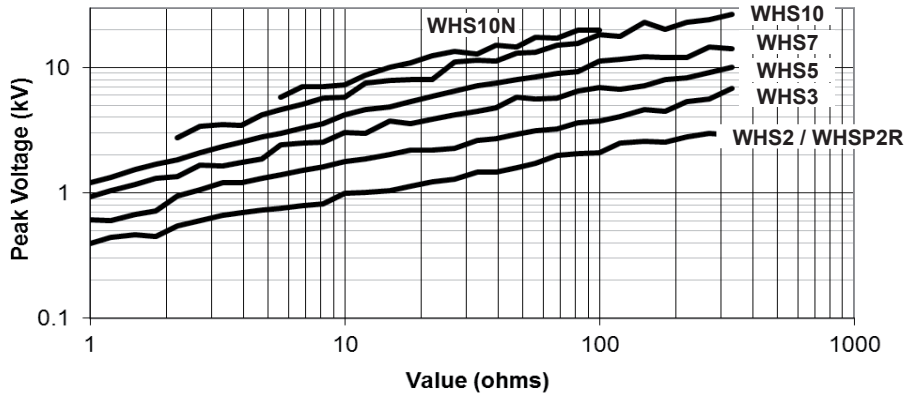

### Thermal Performance

#### Derating Curve

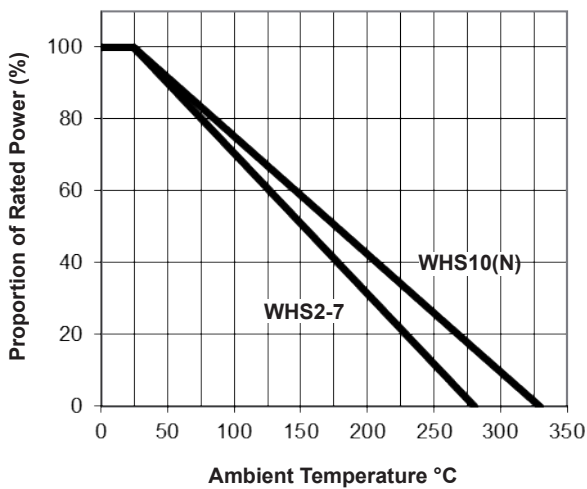

#### Body Temperature Rise

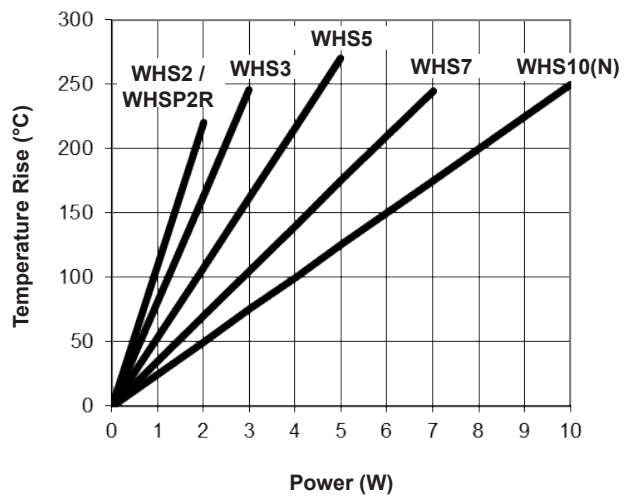

### Application Notes

1. If the resistors are to dissipate full rated power, it is recommended that the terminations should not be soldered closer than 4mm from the body.
2. Due to operating temperature limits imposed by some PCB materials, derating may be necessary. The surface temperature rise at the centre of the body is shown under Thermal Performance.
3. WHS2, WHS3, WHS5 resistors can also be supplied with goalpost or lancet pre-formed leads. Hairpin form is available on WHS2 and WHS3 only.

WHS2, WHS3, and WHS5 are also available in an SMD format with ZI formed leads and packed in blister tape. see <http://www.ttelectronics.com/themes/ttelectronics/datasheets/resistors/ZI-form.pdf>

### General Note

TT Electronics reserves the right to make changes in product specification without notice or liability. All information is subject to TT Electronics' own data and is considered accurate at time of going to print.

WHS Series

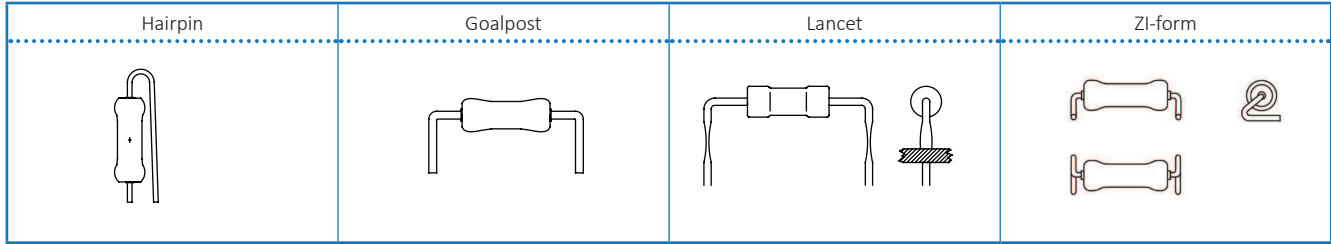

Also a 2W radial taped version\* is available as shown below

WHSP2R Radial Taped Dimensions (mm)			
Dimension	Notation	Nominal	Tolerance
Component Body Length	L	10.0 Max	
Component Body Diameter	D	4.0 Max	
Terminal Lead Diameter	d	0.8 Nom	
Component Pitch	P	12.7	±0.5
Pitch of Holes	Po	12.7	±0.2
Distance between Hole & Component	P1	3.85	±0.3
	P2	5.85	±0.5
Lead Pitch	F	5.0	+0.75 -0.34
Width of Backing Strip	W	18.0	±0.3
Position of Hole	W1	9.0	±0.25
Diameter of Hole	Do	4.0	±0.3
Height to Lead Form	Ho	16.0	±0.3
Height from Lead Form	Ho1	21.7 Max	
Height to Resistor	Ho2	18.0 Max	
Width of Adhesive Tape	W2	15.0	±0.5
Length of protrusion	l	<2.5	
Form Dimensions	K1	2.0	±0.3
	K2	3.0	±0.5
	K3	1.5	±0.25
	K4	1.0	±0.2

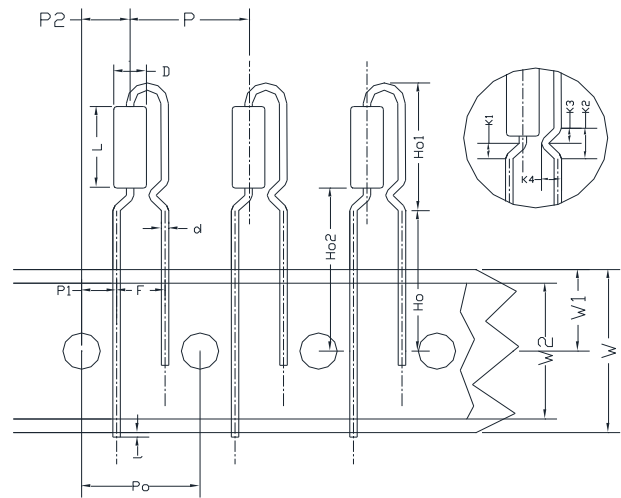

\*Although body dimensions differ slightly, WHSP2R Performance and Electrical Data are identical to those of WHS2

General Note

TT Electronics reserves the right to make changes in product specification without notice or liability. All information is subject to TT Electronics' own data and is considered accurate at time of going to print.

WHS Series

Packaging

The standard packaging for WHS is taped. The critical dimensions are shown below. The component wires will not protrude beyond the outside edge of the tapes. Taped product is then packed into boxes or onto reels. See Ordering Procedure for details. Alternative packaging is available by request. Pre-formed resistors are supplied loose packed in plastic bags or boxes.

Dimensions mm	a	b	c
WHS2	6	52	5
WHS3	6	67	10
WHS5	6	63	10
WHS7	6	85	10
WHS10	9	105	10
WHS10N	9	105	20

Dimensions mm	a	b	c
WHS7U	6	95	10

Ordering Procedure

Example: WHS2-100RJ A25 (WHS2, 100 ohms ±5%, Pb-free)

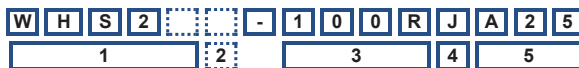

1	2	3	4	5		
Type	Variant	Value	Tolerance	Packing		
WHS2	U = unequal lead length (WHS7 only)	3/4 characters	F = ±1%	A25	WHS2	Ammo pack, 2500/box
WHS3		R = ohms	G = ±2%	A1	WHS3	Ammo pack, 1000/box
WHS5		J = ±5%	T075	WHS5	Tape & reel, 750/reel	
WHS7	N = non-inductive (WHS10 only)			T07	WHS7(U)	Tape & reel, 700/reel
WHS10				A02	WHS10	Ammo pack, 200/box
					A01	WHS10N

Example: WHSP2R-100RJ T15 (WHSP2R radially formed & taped, 100 ohms ±5%, Pb-free)

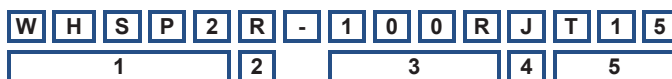

1	2	3	4	5	
Type	Leadforming	Value	Tolerance	Packing	
WHSP2	R = Radial taped	3/4 characters	F = ±1%	T15	Tape & reel, 1500/reel
		R = ohms	G = ±2%		
			J = ±5%		

General Note

TT Electronics reserves the right to make changes in product specification without notice or liability. All information is subject to TT Electronics' own data and is considered accurate at time of going to print.