



Chipsmall Limited consists of a professional team with an average of over 10 year of expertise in the distribution of electronic components. Based in Hongkong, we have already established firm and mutual-benefit business relationships with customers from,Europe,America and south Asia,supplying obsolete and hard-to-find components to meet their specific needs.

With the principle of "Quality Parts,Customers Priority,Honest Operation,and Considerate Service",our business mainly focus on the distribution of electronic components. Line cards we deal with include Microchip,ALPS,ROHM,Xilinx,Pulse,ON,Everlight and Freescale. Main products comprise IC,Modules,Potentiometer,IC Socket,Relay,Connector.Our parts cover such applications as commercial,industrial, and automotives areas.

We are looking forward to setting up business relationship with you and hope to provide you with the best service and solution. Let us make a better world for our industry!



## Contact us

Tel: +86-755-8981 8866 Fax: +86-755-8427 6832

Email & Skype: info@chipsmall.com Web: www.chipsmall.com

Address: A1208, Overseas Decoration Building, #122 Zhenhua RD., Futian, Shenzhen, China



# WizFi250 Datasheet

(Version 1.01)



©2013 WIZnet Co., Ltd. All Rights Reserved.

☞ For more information, visit our website at <http://www.wiznet.co.kr>

☞ For latest version of this document, visit our Wiki site at <http://wizwiki.net/wiki/>

## Document Revision History

Date	Revision	Changes
2013.11.28	V1.00	Official Release
2014.4.2	V1.01	Fixed some mistyping Add JTAG_TCK (Pin Number 54)

## <Contents>

1.	Introduction .....	1
2.	Features.....	2
3.	Block diagram.....	3
4.	Pin description.....	4
4.1.	Pin map.....	4
4.2.	Pin description .....	5
5.	Technical specification .....	8
5.1.	Absolute maximum rating.....	8
5.2.	Recommendable operation condition.....	8
5.2.1.	Temperature, humidity.....	8
5.2.2.	Voltage.....	8
5.2.3.	Current consumption.....	9
5.3.	Wireless specifications.....	9
5.4.	Specifications of WiFi's output power, evm, sensitivity .....	11
6.	I/O port characteristics .....	12
7.	Dimensions, weight and mounting .....	13
7.1.	Dimensions .....	13
7.2.	Pin out and pin description .....	14
7.3.	Recommend footprint.....	15
8.	Design Guide .....	16
8.1.	PCB Antenna Guide.....	16
8.1.1.	Module Location Recommendation.....	16
8.1.2.	Module Layout Guideline.....	17
8.1.3.	Antenna Simulation Result .....	18
8.1.4.	Antenna Measurement Setup .....	19
8.1.5.	Antenna Measurement Results.....	20
8.2.	Firmware Update – Circuit Guide.....	21
8.2.1.	Case 1.....	21
8.2.2.	Case 2.....	22
9.	Recommend reflow profile.....	24
10.	Reference schematic .....	25

## 1. Introduction

WizFi250 is a small size wireless module for the highest level of integration, featuring 802.11b/g and 802.11n.

It includes a 2.4 GHz WLAN CMOS power amplifier (PA) that meets the output power requirements of most handheld systems.

Along with the integrated power amplifier, the WizFi250 also includes integrated transmit and receive baluns, further reducing the overall solution cost.

The small size and low profile physical design eases enabling high performance wireless connectivity without space constraint in system designs.

Hardware WAPI acceleration engine, AES, TKIP, WPA and WPA2 are supported to provide your network with the latest security requirements.

For software and driver development, WIZnet provides extensive technical documents and reference software codes for system integration.

## 2. Features

- Single band 2.4GHz IEEE 802.11b/g/n
- Integrated RF power amplifier
- Supports wireless data rates up to 65Mbit/s
- 1MB Flash Memory, 128KB SRAM, 1MB Serial Flash
- Supports per packet Rx Antenna diversity
- Low power consumption & excellent power management performance to extend battery life.
- Small size, suitable for low volume system integration
- Easy integration into mobile and handheld device flexible system configuration.
- 2.412-2.484 GHz two SKUs for worldwide market.
- Lead Free design supporting Green design requirements, RoHS Compliance.
- Device Package : 28x20 mm (17x20 mm)
- Serial Interface : UART, SPI
- Powerful Web server provides
  - Soft AP
    - Sufficient memory retention
    - Wi-Fi Security (WEP, WPA/WPA2PSK)
    - L2 Switching
- OTA(Over The Air F/W Upgrading)

### 3. Block diagram

The WizFi250 module is designed based on WiFi block and MCU block. It supports generic SPI, UART interface to connect WLAN to the host processor. A simplified block diagram of the WizFi250 module is depicted in the Fig. below.

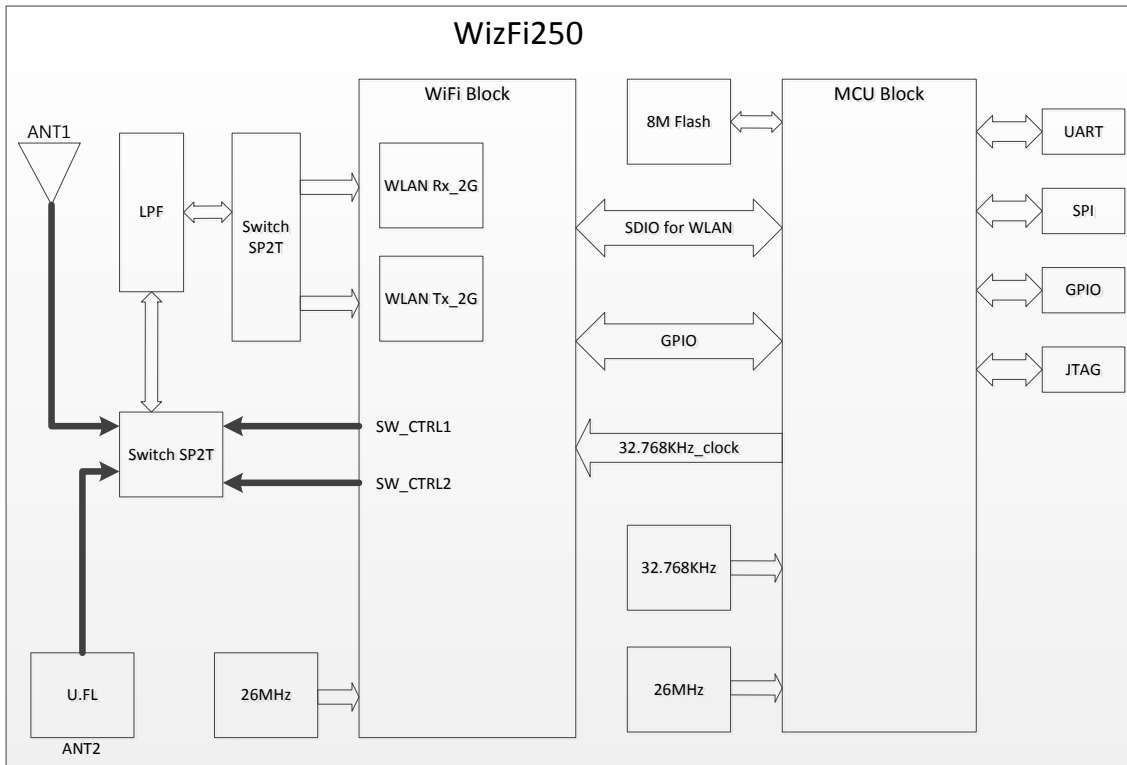

## 4. Pin description

### 4.1. Pin map

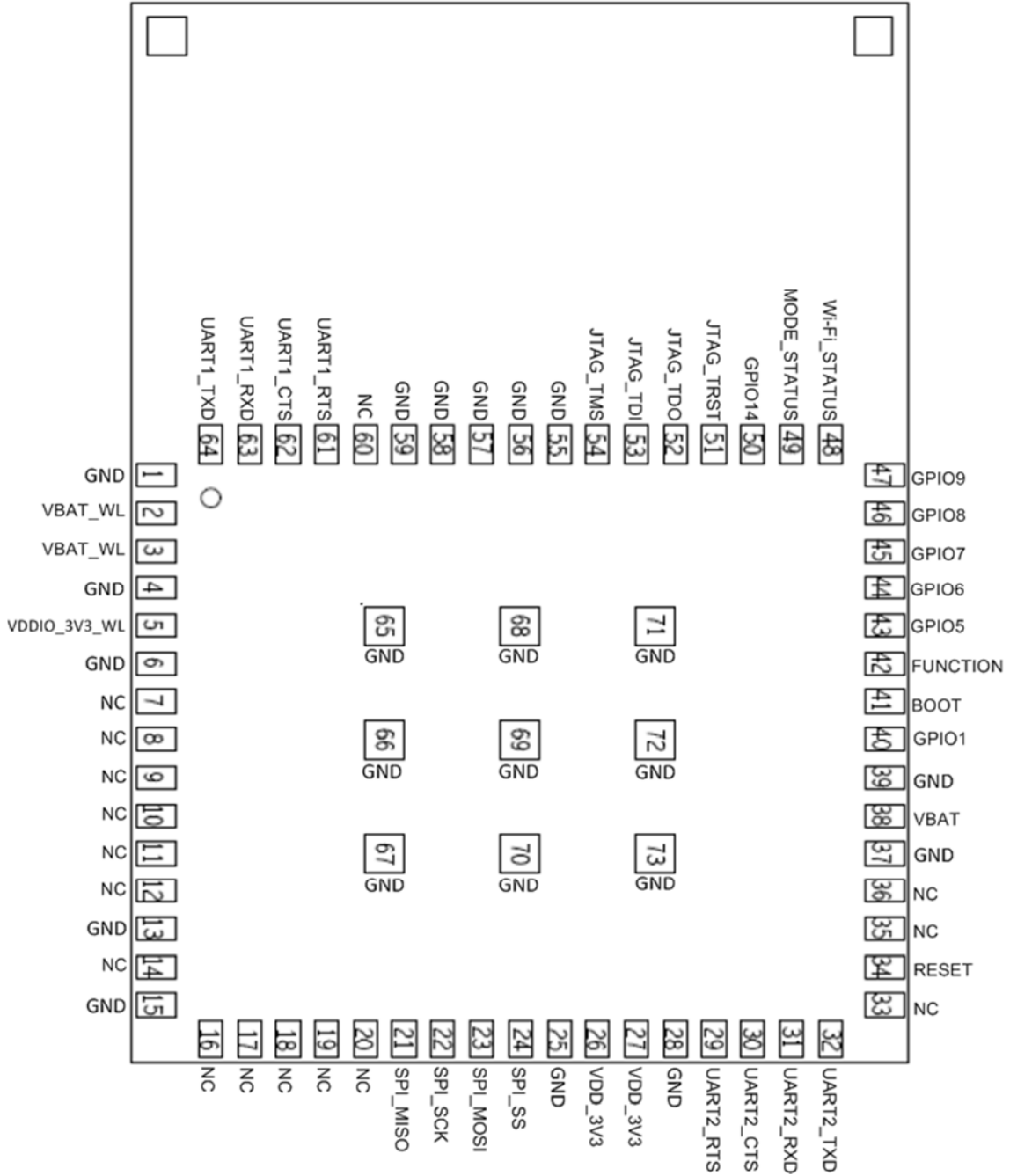



## 4.2. Pin description

Pin Number	Pin Define	Type	Description
1	GND	--	Ground
2	VBAT_WL	I	Battery supply input
3	VBAT_WL	I	Battery supply input
4	GND	--	Ground
5	VDDIO_3V3_WL	I	Digital I/O supply.
6	GND	--	Ground
7	NC	--	--
8	NC	--	--
9	NC	--	--
10	NC	--	--
11	NC	--	--
12	NC	--	--
13	GND	--	Ground
14	NC	--	--
15	GND	--	Ground
16	NC	--	--
17	NC	--	--
18	NC	--	--
19	NC	--	--
20	NC	--	--
21	SPI_MISO	I/O	SPI Master In Slave Out
22	SPI_SCK	I/O	SPI Clock
23	SPI_MOSI	I/O	SPI Master Out Slave In
24	SPI_SS	I/O	SPI Slave Select
25	GND	--	Ground
26	VDD_3V3	I	Power supply for I/O and the internal regulator
27	VDD_3V3	I	Power supply for I/O and the internal regulator
28	GND	--	Ground
29	UART2_RTS	I/O	Active-low request-to-send signal for UART2 interface( <b>Not Used</b> )
30	UART2_CTS	I/O	Active-low clear-to-send signal for UART2 interface( <b>Not Used</b> )

31	UART2_RXD	I	Serial data input for UART2 interface( <b>Not Used</b> )
32	UART2_TXD	O	Serial data output for UART2 interface( <b>Not Used</b> )
33	NC	--	--
34	RESET	I	RESET pin (Active Low)
35	NC	--	--
36	NC	--	--
37	GND	--	Ground
38	VBAT	I	Power supply when VDD_3V3 is not present.
39	GND	--	Ground
40	GPIO1	I/O	GPIO1 pin
41	BOOT	I	BOOT MODE pin (Active low)
42	FUNCTION	I	FUNCTION pin (Active Low)
43	GPIO5	I/O	GPIO5 pin
44	GPIO6	I/O	GPIO6 pin
45	GPIO7	I/O	GPIO7 pin
46	GPIO8	I/O	GPIO8 pin
47	GPIO9	I/O	GPIO9 pin
48	WiFi_STATUS	I/O	Wi-Fi Status Pin
49	MODE_STATUS	I/O	Mode Status Pin
50	GPIO14	I/O	GPIO14 pin
51	JTAG_TRST	I	For normal operation, if JTAG is not used, this pin can be left unconnected (NC)
52	JTAG_TDO	I/O	For normal operation, if JTAG is not used, this pin can be left unconnected (NC)
53	JTAG_TDI	I/O	For normal operation, if JTAG is not used, this pin can be left unconnected (NC)
54	JTAG_TMS	I	For normal operation, if JTAG is not used, this pin can be left unconnected (NC)
55	JTAG_TCK	I	For normal operation, if JTAG is not used, this pin can be left unconnected (NC)
56	GND	--	Ground
57	GND	--	Ground
58	GND	--	Ground
59	GND	--	Ground

60	NC	--	--
61	UART1_RTS	I/O	Active-low request-to-send signal for UART interface( <b>Use</b> )
62	UART1_CTS	I/O	Active-low clear-to-send signal for UART interface( <b>Use</b> )
63	UART1_RXD	I	Serial data input for UART interface( <b>Use</b> )
64	UART1_TXD	O	Serial data output for UART interface( <b>Use</b> )
65~73	GND	--	Ground

## 5. Technical specification

### 5.1. Absolute maximum rating

<b>Supply Power</b>	Max +3.6 Volt	
<b>NonOperating Temperature</b>	- 40° to 85° Celsius	
<b>Voltage ripple</b>	+/- 2% Max	Values not exceeding Operating voltage

### 5.2. Recommendable operation condition

#### 5.2.1. Temperature, humidity

The WizFi250 can withstand the operational requirements as listed in the table below.

<b>Operating Temperature</b>	-20° to 85° Celsius	
<b>Humidity range</b>	Max 95%	Non condensing, relative humidity

\* The maximum operating ambient temperature can be up to 85°. Exposure to absolute-maximum-rated conditions may cause performance degradation and affect device reliability. For the best performance -20° to 75° is recommended.

#### 5.2.2. Voltage

Power supply for the WizFi250 module will be provided by the host via power pins

<b>Symbol</b>	<b>Parameter</b>	<b>Min</b>	<b>Typ.</b>	<b>Max</b>	<b>Unit</b>
VBAT_WL	power supply for WizFi250	3.0	3.3	3.6	V
VDDIO_3V3_WL	host Interface power supply	3.0	3.3	3.6	V
VBAT_MICRO	backup operating voltage	3.0	3.3	3.6	V
VDD_3V3	power supply for MCU	3.0	3.3	3.6	V

### 5.2.3. Current consumption

The WizFi250 on operation output current consumption :

MCU mode	WiFi mode (802.11n)	Typ. (RMS)	Max.
Normal mode	Not Associated	14 mA	18 mA
Normal mode	Associated	67 mA	69 mA
Normal mode	Associated (IEEE Power Save mode)	32 mA	65 mA
Stop mode	Associated (IEEE Power Save mode)	14 mA	17 mA
Stop mode	Not Associated	3 mA	23 mA

The WizFi250 on TX mode output current consumption :

(Typical spec is defined @3.3V 25°C ; MAX. spec is defined @3.0V 70°C)

Current Consumption	TYP.	MAX.
Tx output power @16.5 dBm on 11b 1M	385 mA	430 mA
Tx output power @ 16.5 dBm on 11b 11M	370 mA	410 mA
Tx output power @ 15 dBm on 11g 6M	345 mA	380 mA
Tx output power @ 13 dBm on 11g 54M	290 mA	320 mA
Tx output power @ 14.5 dBm on 11n MCS0	315 mA	350 mA
Tx output power @ 12 dBm on 11n MCS7	265 mA	295 mA

The WizFi250 on RX mode current consumption :

(Typical spec is defined @3.3V 25°C; MAX. spec is defined @3.0V 70°C)

Current Consumption	TYP.	MAX.
Rx @ 11b 1M	120 mA	150 mA
Rx @ 11b 11M	120 mA	150 mA
Rx @ 11g 6M	120 mA	150 mA
Rx @ 11g 54M	120 mA	150 mA
Rx @ 11n MCS0	120 mA	150 mA
Rx @ 11n MCS7	120 mA	150 mA

### 5.3. Wireless specifications

WizFi250 complies with following features and standards;

Features	Description
WLAN Standards	IEEE 802 11 b/g/n
Antenna Connector Port	One printed antenna, one U.FL connector for external antenna
Frequency Band	2.400 GHz – 2.484 GHz

---

Number of Sub Channels	CH1 to CH14	
Modulation	DSSS, CCK, OFDM, BPSK, QPSK, 16QAM, 64QAM	
Supported data rates	11b	1, 2, 5.5, 11 (Mbps)
	11g	6, 9, 12, 18, 24, 36, 48, 54 (Mbps)
	11n	HT20 MCS0(6.5Mbps) to HT20 MCS7(65Mbps)

## 5.4. Specifications of WiFi's output power, evm, sensitivity

The WizFi250 Wi-Fi output power is listed in the table below:

Characteristics		TYP.	Criteria	Unit
RF Average Output Power, 802.11b CCK Mode	1M	16.5	+/- 1.5	dBm
	11M	16.5	+/- 1.5	dBm
RF Average Output Power, 802.11g OFDM Mode	6M	15	+/- 1.5	dBm
	54M	13	+/- 1.5	dBm
RF Average Output Power, 802.11n OFDM Mode	MCS0	14.5	+/- 1.5	dBm
	MCS7	12	+/- 1.5	dBm

Wi-Fi TX EVM following the IEEE spec as listed in the table below:

Characteristics		IEEE Spec	Unit
RF Average Output EVM (11b)	@1 Mbps	-10	dB
	@11 Mbps	-10	dB
RF Average Output EVM (11g)	@6 Mbps	-5	dB
	@54 Mbps	-25	dB
RF Average Output EVM (11n)	@ MCS0	-5	dB
	@ MCS7	-28	dB

The WizFi250 Wi-Fi sensitivity as listed in the table below:

Receiver Characteristics	TYP.	MAX.	Unit
PER <8%, Rx Sensitivity @ 1 Mbps	-96	-89	dBm
PER <8%, Rx Sensitivity @ 11 Mbps	-88	-84	dBm
PER <10%, Rx Sensitivity @ 6 Mbps	-90	-83	dBm
PER <10%, Rx Sensitivity @ 54 Mbps	-74	-70	dBm
PER <10%, Rx Sensitivity @ MCS0	-89	-83	dBm
PER <10%, Rx Sensitivity @ MCS7	-71	-67	dBm

## 6. I/O port characteristics

WizFi250 is a small size wireless module. Unless otherwise specified, parameters are given as in the table below

Table I/O static characteristics

Symbol	Parameter	Conditions	Min	Typ	Max	Unit
V <sub>IL</sub>	Standard IO input low level voltage		-0.3		0.28*(V <sub>DD</sub> -2V)+0.8V	V
	IO FT <sup>(1)</sup> input low level voltage		-0.3		0.32*(V <sub>DD</sub> -2V)+0.75V	V
V <sub>IH</sub>	Standard IO input high level voltage		0.41*(V <sub>DD</sub> -2V)+1.3V		V <sub>DD</sub> +0.3	V
	IO FT <sup>(1)</sup> input high level voltage	V <sub>DD</sub> > 2V	0.42*(V <sub>DD</sub> -2V)+1V		5.5	V
		V <sub>DD</sub> ≤ 2V		5.2		
V <sub>hys</sub>	Standard IO Schmitt trigger voltage hysteresis <sup>(2)</sup>		200			mV
	IOFT Schmitt trigger voltage hysteresis <sup>(2)</sup>		5%V <sub>DD</sub> <sup>(3)</sup>			mV
I <sub>lk</sub>	Input leakage current <sup>(4)</sup>	V <sub>SS</sub> ≤ V <sub>IN</sub> ≤ V <sub>DD</sub> Standard I/Os			±1	μA
		V <sub>IN</sub> =5V, I/O FT			3	
R <sub>PU</sub>	Weak pull-up equivalent resistor <sup>(5)</sup>	V <sub>IN</sub> =V <sub>SS</sub>	30	40	50	k Ω
R <sub>PD</sub>	Weak pull-down equivalent resistor <sup>(5)</sup>	V <sub>IN</sub> =V <sub>DD</sub>	30	40	50	k Ω
C <sub>IO</sub>	I/O pin capacitance			5		pF

1. FT = Five-volt tolerant. In order to sustain a voltage higher than V<sub>DD</sub>+0.3 the internal pull-up/pull-down resistors must be disabled.
2. Hysteresis voltage between Schmitt trigger switching levels. Based on characterization, not tested in production.
3. With a minimum of 100 mV.
4. Leakage could be higher than max. if negative current is injected on adjacent pins.
5. Pull-up and pull-down resistors are designed with a true resistance in series with aswitchable PMOS/NMOS. The MOS/NMOS contribution to the series resistance is minimum(~10% order).



## 7. Dimensions, weight and mounting

The following paragraphs provide the requirements for size, weight and mounting of the WizFi250.

### 7.1. Dimensions

28 mm (W) x 20 mm (L) x 1.9 mm (H) (+/-0.1mm) (PCB Antenna, including metal shielding)

17 mm (W) x 20 mm (L) x 1.9 mm (H) (+/-0.1mm)

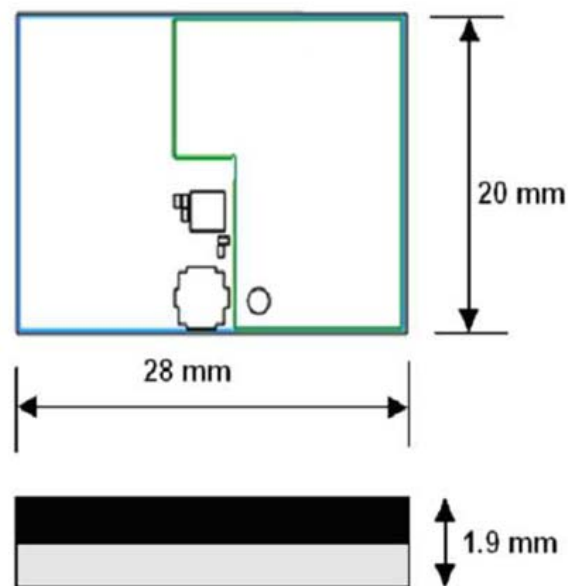

## 7.2. Pin out and pin description

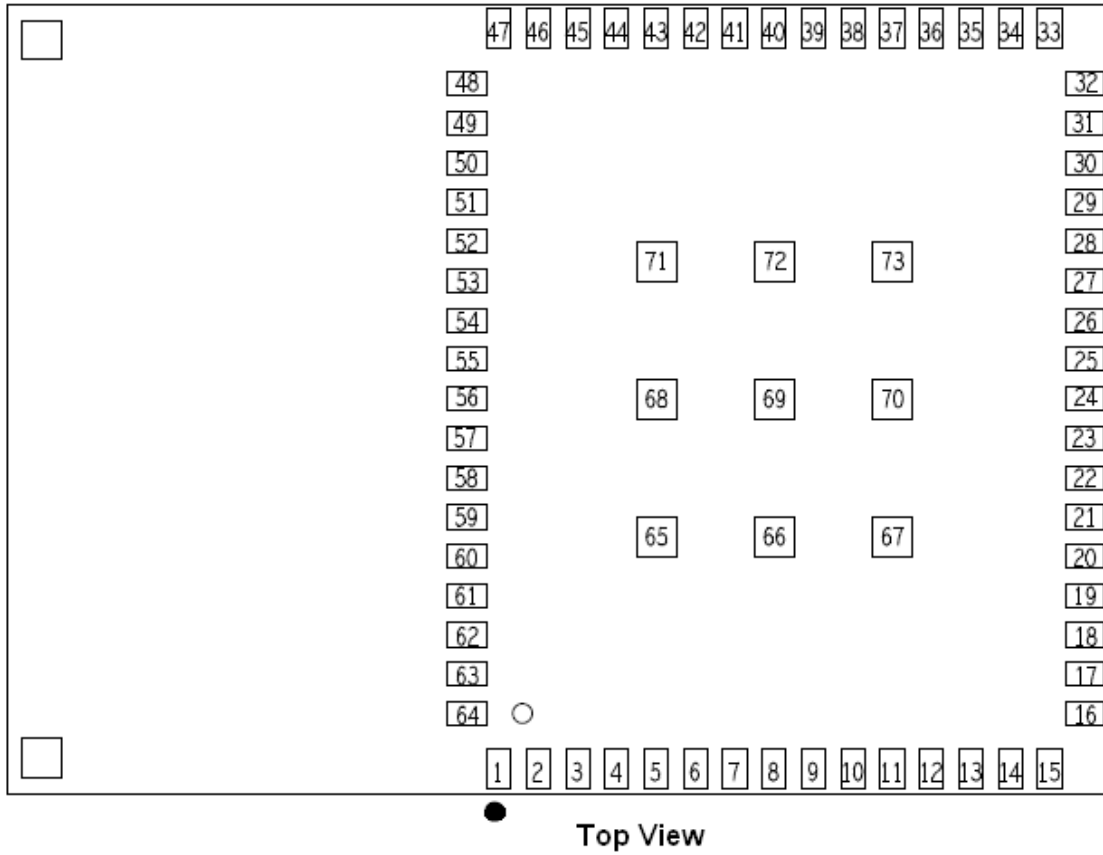

### 7.3. Recommend footprint

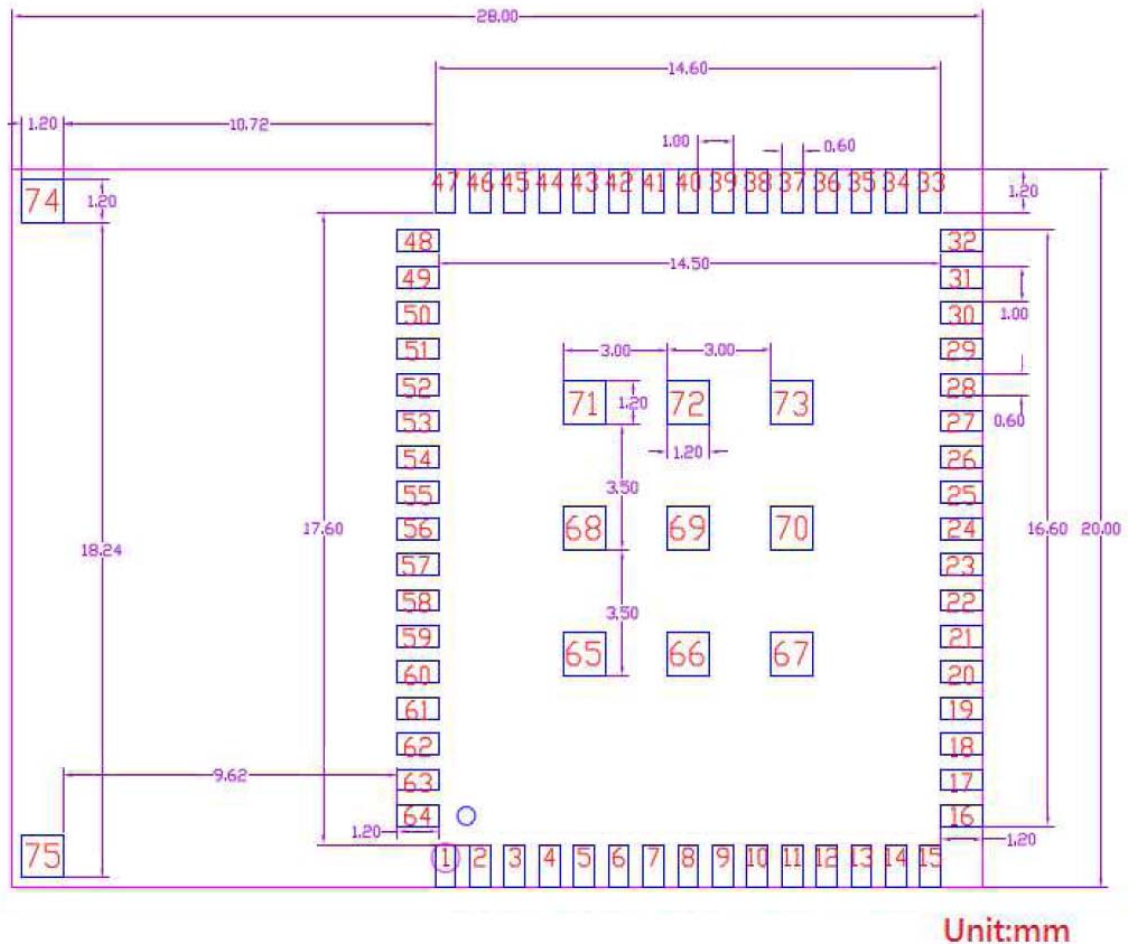

## 8. Design Guide

### 8.1. PCB Antenna Guide

#### 8.1.1. Module Location Recommendation

To get better antenna performance, the following two module locations are advised.

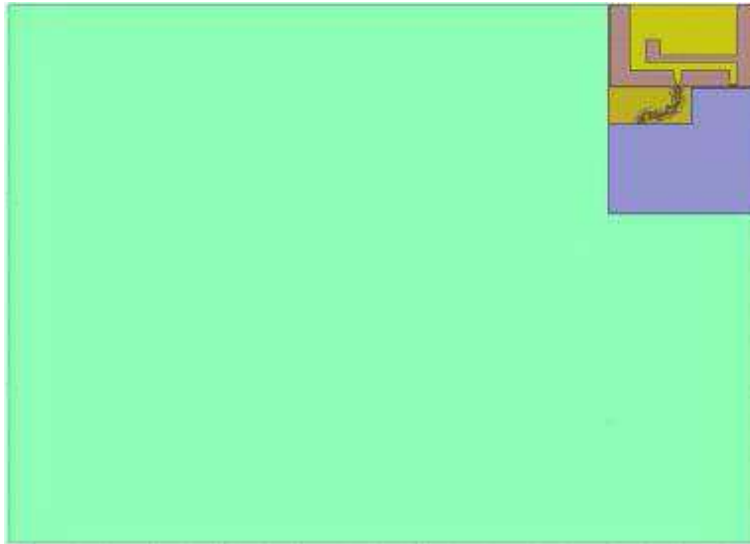

- **Location 1:** Module is recommended to be on the upper right corner of main board.

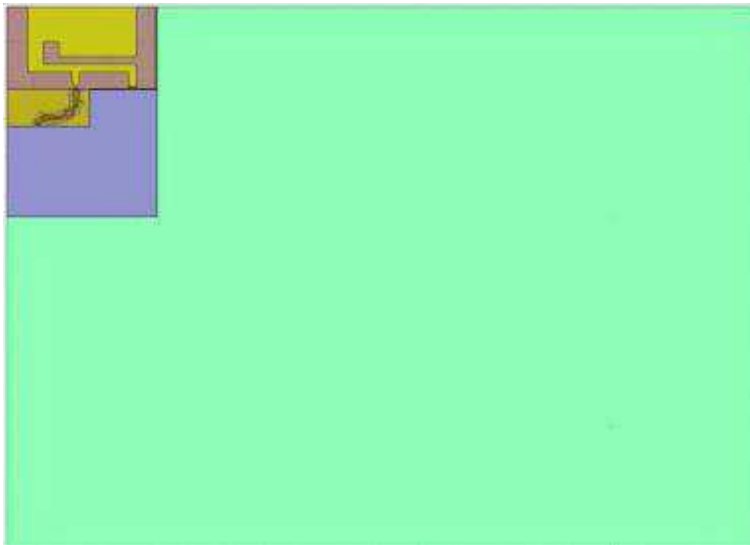



- **Location 2:** Module is recommended to be on the upper left corner of main board.

### 8.1.2. Module Layout Guideline

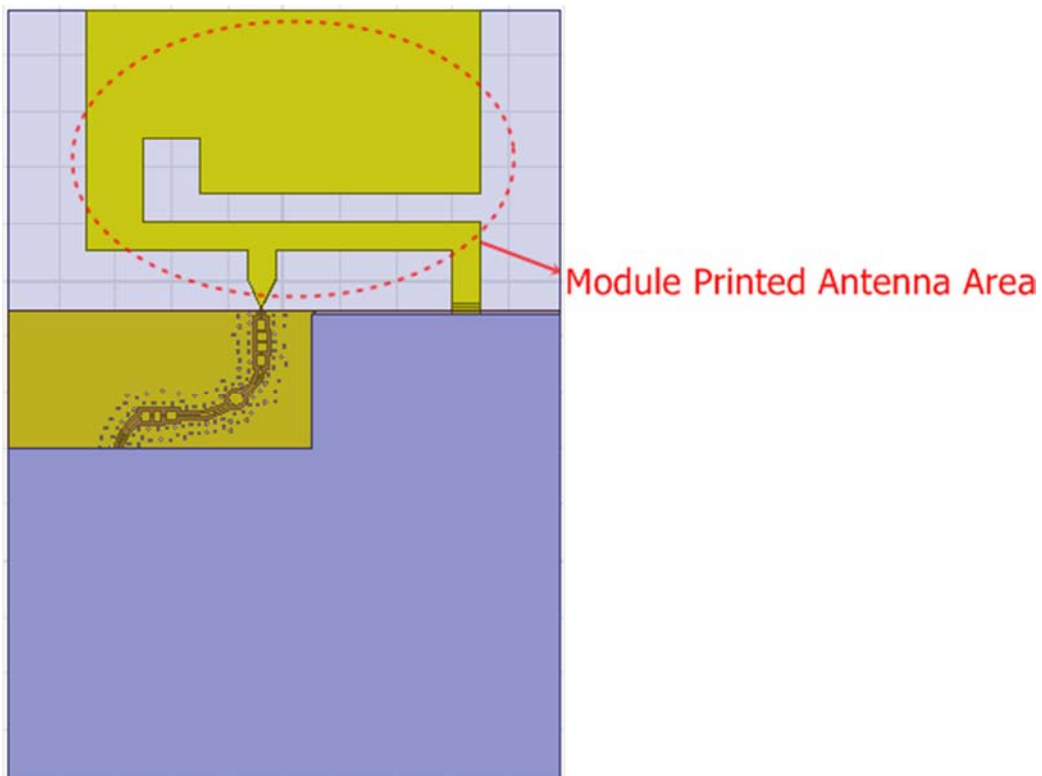
- Main board antenna area under module printed antenna should be clear or empty.
- No signals, GND or power traces can be routed in antenna area for each layers of the main board.
- Any metal lids, power traces or metal components should be placed far away from the antenna area on the main board.
- Keep GND plane as large as you can on main board.

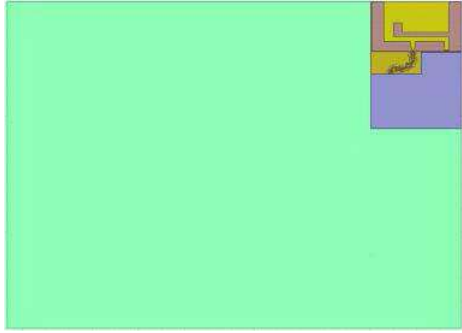
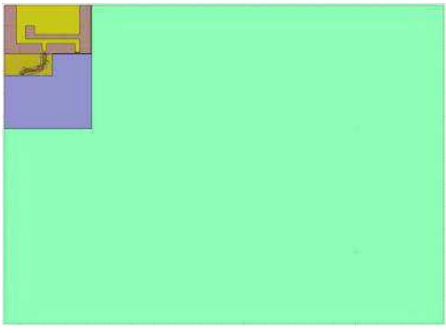
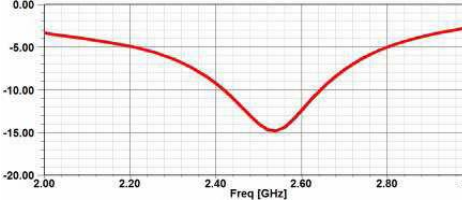

### 8.1.3. Antenna Simulation Result

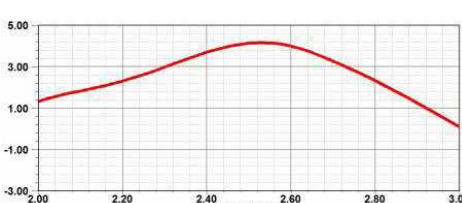
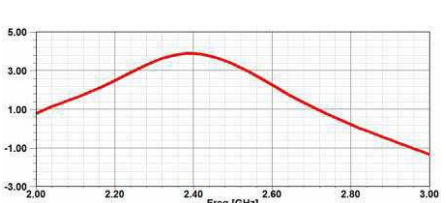
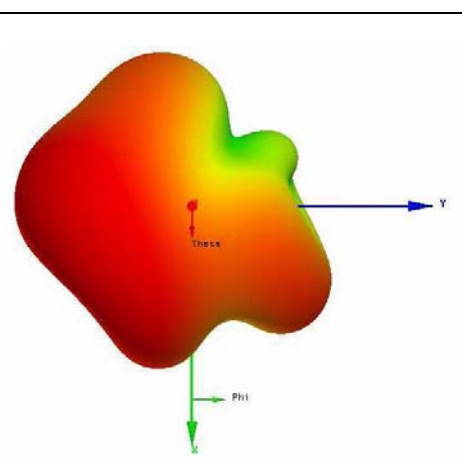
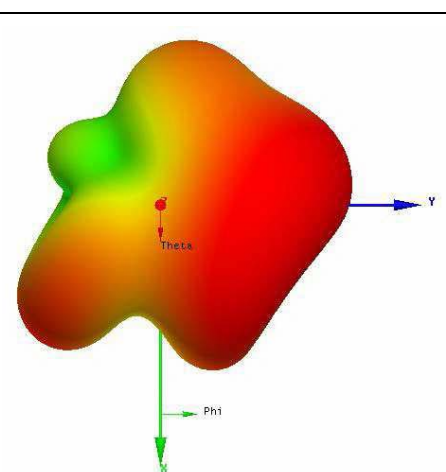
	Ant. on right-up corner	Ant. on left-up corner
Configuration		
S11		
Gain		
3D Pattern		

#### 8.1.4. Antenna Measurement Setup

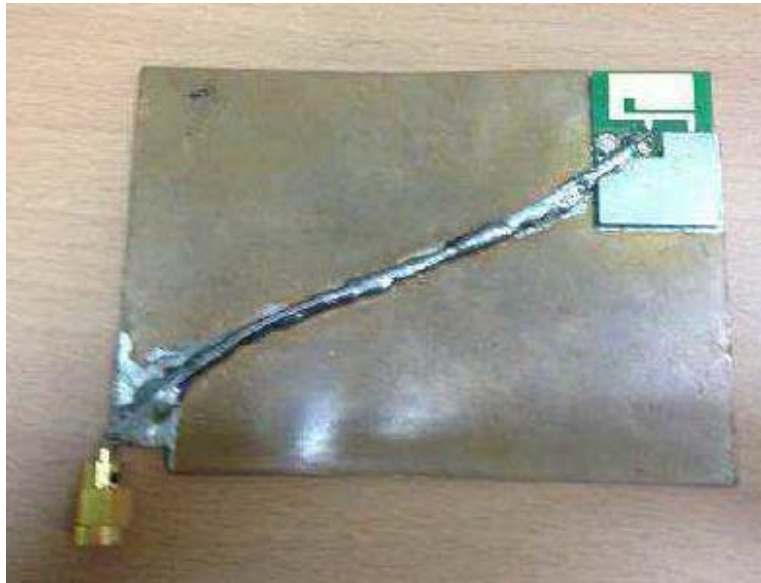

Module is on the upper right corner of main board for performance measurement.

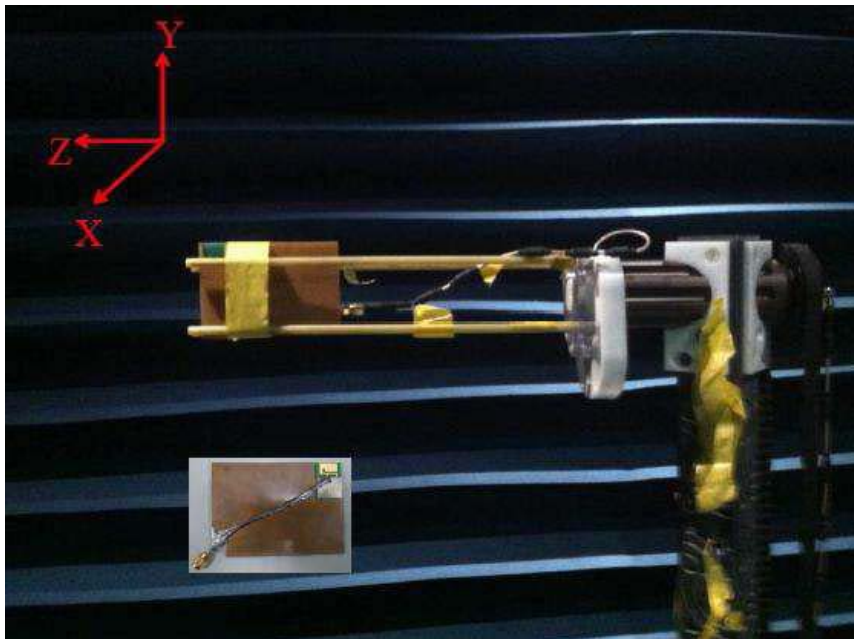

Antenna measurement setup as the figure.

### 8.1.5. Antenna Measurement Results

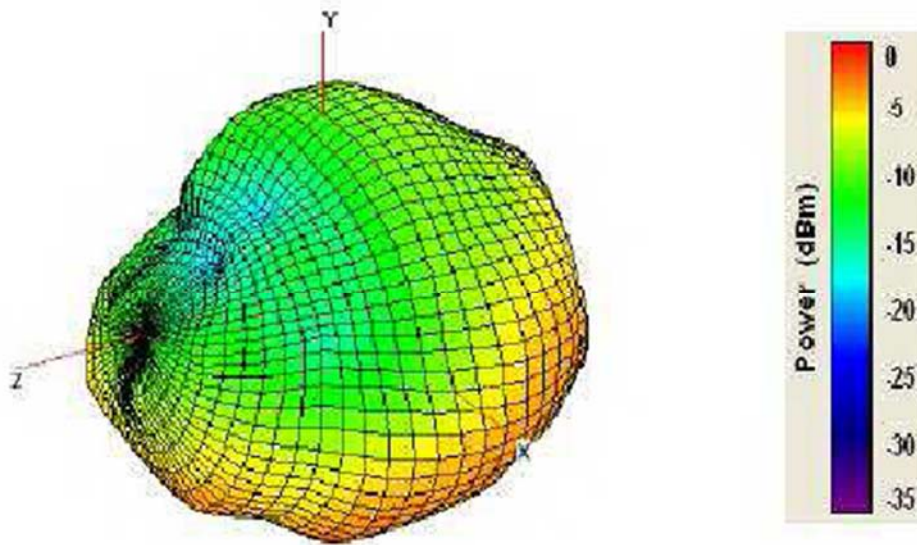

Antenna Pattern

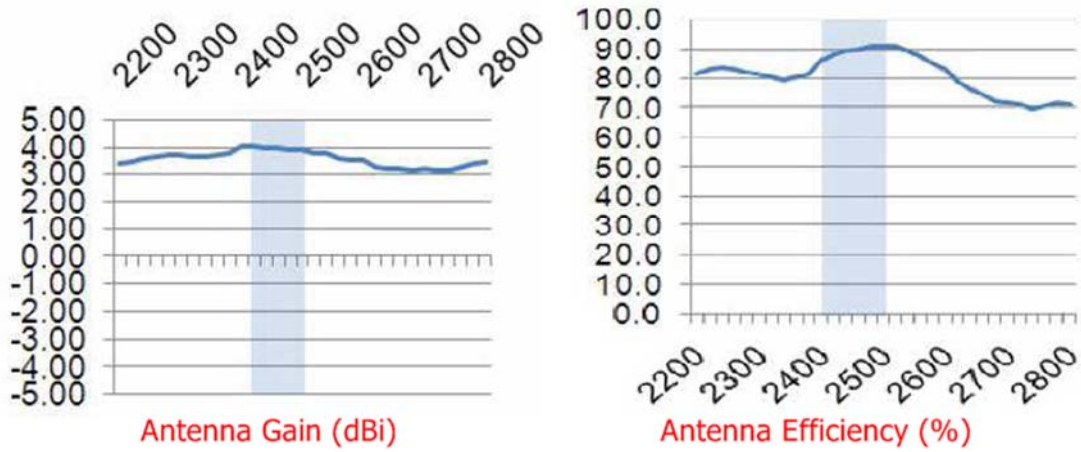

Antenna Gain (dBi)

Antenna Efficiency (%)



## 8.2. Firmware Update– Circuit Guide

WizFi250 provides some specific functions according to its firmware. Until now, there is a standard firmware and some customized firmware to specific customers available. It is possible to perform firmware updates.

WizFi250 decides its operating mode according to the input value of the BOOT signal. WizFi250 operates in boot mode when the BOOT input value is “LOW”, otherwise it operates in the standard run mode. WizFi250 communicates with a PC via UART in order to upload another firmware, so you have to connect UART1\_RXD and UART1\_TXD to the external interface for communicating with PC. Two different schematics for that connection are listed below.

### 8.2.1. Case 1

A simple circuit for updating firmware. If your application MCU has UART communication with WizFi250, there is a possibility that the firmware update with an external PC will fail because of dual use of the one UART interface. In that case WIZnet cannot guarantee a completely successful update.

Therefore, please monitor the signal of BOOT of your MCU. Please stop the UART communication between your MCU and the WizFi250 when BOOT input value is “LOW”. After the detection of a “LOW” BOOT signal you can succeed firmware update.

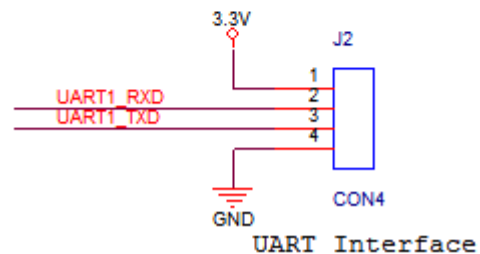
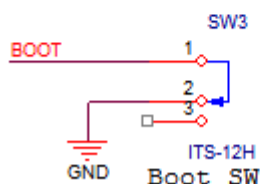
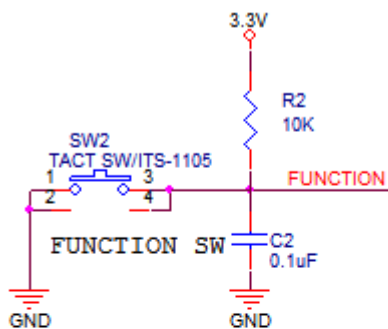

### 8.2.2. Case 2

This circuit selects the UART communication using some extra hardware. If the BOOT SW is ON(GND), it is the BOOT Mode, and if the BOOT SW is OFF(3.3V), it is RUN Mode. The UART signal of the WizFi250 is connected on the firmware update UART(PC) when it becomes BOOT Mode, so firmware updates are made possible. The UART signal of the WizFi250 is only connected on your MCU if the BOOT signal is “High” and WizFi250 goes into the RUN mode.

