



Chipsmall Limited consists of a professional team with an average of over 10 year of expertise in the distribution of electronic components. Based in Hongkong, we have already established firm and mutual-benefit business relationships with customers from,Europe,America and south Asia,supplying obsolete and hard-to-find components to meet their specific needs.

With the principle of “Quality Parts,Customers Priority,Honest Operation,and Considerate Service”,our business mainly focus on the distribution of electronic components. Line cards we deal with include Microchip,ALPS,ROHM,Xilinx,Pulse,ON,Everlight and Freescale. Main products comprise IC,Modules,Potentiometer,IC Socket,Relay,Connector.Our parts cover such applications as commercial,industrial, and automotives areas.

We are looking forward to setting up business relationship with you and hope to provide you with the best service and solution. Let us make a better world for our industry!



## Contact us

Tel: +86-755-8981 8866 Fax: +86-755-8427 6832

Email & Skype: info@chipsmall.com Web: www.chipsmall.com

Address: A1208, Overseas Decoration Building, #122 Zhenhua RD., Futian, Shenzhen, China



## Wide Range of Two-circuit Switches; Select One for the Operating Environment/Application

- A wide selection of models are available, including the overtravel models with greater OT, indicator-equipped models for checking operation, low-temperature models, heat-resistant models, and corrosion-proof models.
  - Microload models are added to the product lineup.
  - Approved standards: EC/IEC, UL, CSA, CCC (Chinese standard).
- Contact your OMRON representative for information on approved models.



 Be sure to read *Safety Precautions* on page 39 to 42 and *Safety Precautions for All Limit Switches*.

## Features

### Standard Models

#### Many Variations in Standard Limit Switches A Wide Range of Models

The WL Series provides a complete range of Limit Switches with a long history of meeting user needs. Select environment-resistant specifications, actuators for essentially any workpiece, operating sensitivity matched to the workpiece, operation indicators to aid operation and maintenance, and various wiring specifications.

### Environment-resistant Models

#### Select from Six Types of Environment Resistance

The series includes Airtight Switches, Hermetic Switches, Heat-resistant Switches, Low-temperature Switches, Corrosion-proof switches, and Weather-proof Switches. Select the one required by the onsite environment.

### Spatter-prevention Models

#### Excellent Performance on Arc Welding Lines or Sites with Spattering Cutting Powder Ideal for Welding Sites

Stainless steel and resins that resist adhesion of spatters are used to prevent troubles caused by zinc powder generated during welding.

### Long-life Models

#### Mechanical Endurance of 30 Million Operations Long-life Models for High-frequency Applications

Long life has been achieved by increasing the resistance to friction and creating better sliding properties in the head mechanism. Greater visibility is provided when setting with a fluorescent display for setting the stroke.

### Features Common to All Models

#### DPDB Operation

The double-pole, double-break structure ensures circuit braking.

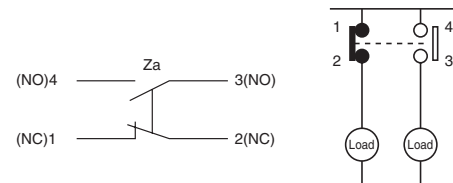

#### Degree of Protection; IP67

O-rings, cover seals, and other measures provide a water-proof, drip-proof structure (IP67).

#### Approved Standards to Aid Export Machines

Various WL/WLM switches are approved by UL, CSA, TÜV, EN/IEC, and CCC making them ideal for export machines.

#### High-precision Models Available in All Switch Types; Ideal for Position Control

High-precision models achieve a very small movement to operation (approx. 5°) and a repeat accuracy that is twice that of basic models.

#### Operation Indicators for Easier Daily Inspections\*

Confirm operation with a neon lamp or LED for easier startup confirmations and maintenance.

\* Operation indicators are provided on Indicator-equipped switches, Spatter-prevention Basic Switches, and Long-life Basic Switches.

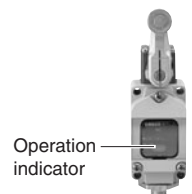

#### Models with Connectors to Reduce Wiring

Reduce wiring with one-touch connection. Models with direct-wired and prewired connectors that make Switch replacement easier are also available.

Product Configuration

Selection by Purpose

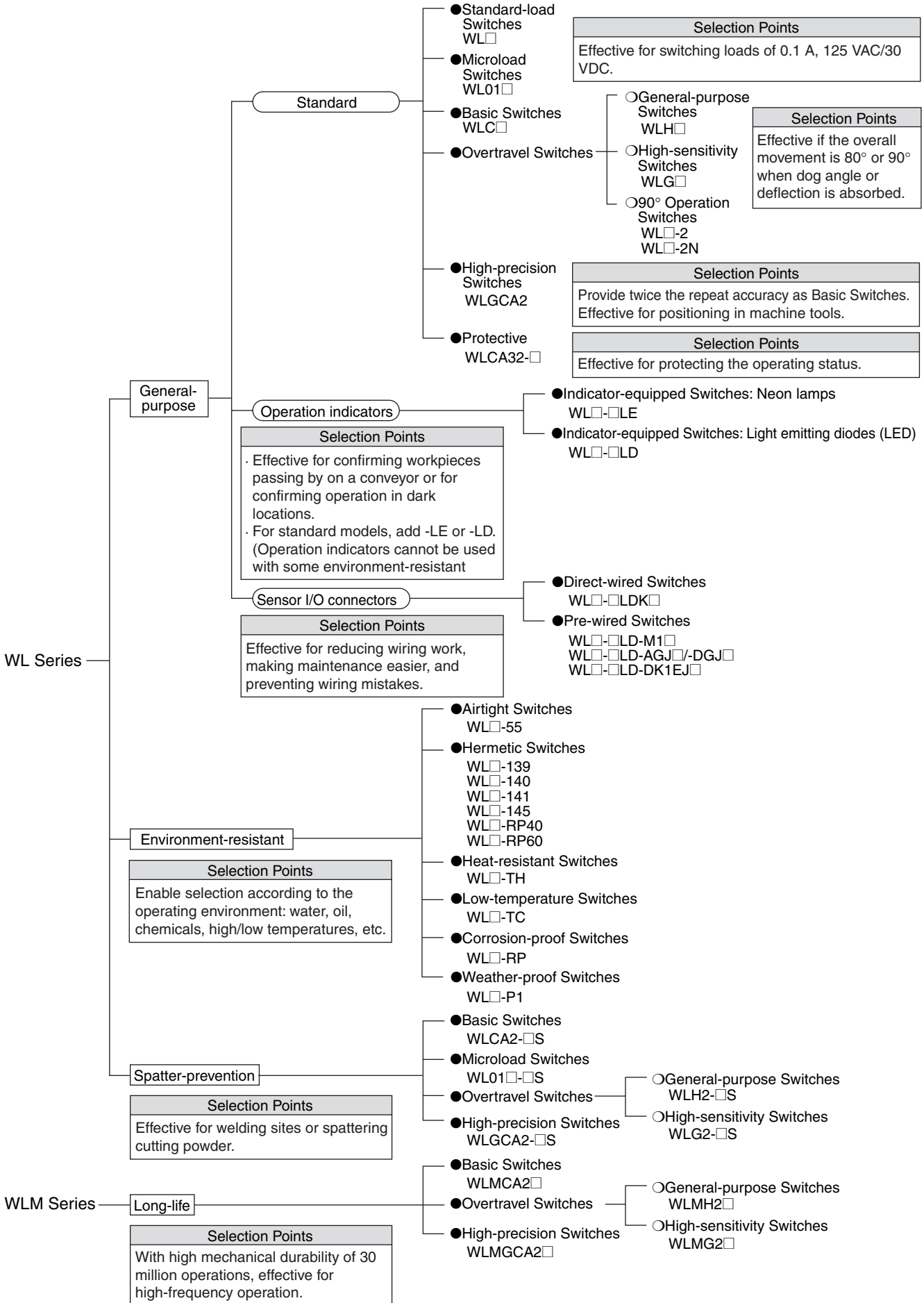

Tables of Models

General-purpose Switches

Spatter-prevention Switches

Long-life Switches

Heads (Roller levers only)

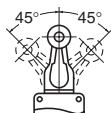
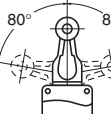
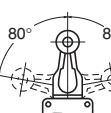
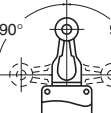
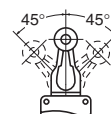
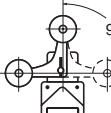
Type	General purpose	Features	Head specifications		Spatter prevention	Long-life
	Model		Total travel (TT)	One-side operation	Head mounting	Model
Basic	WLC□	<ul style="list-style-type: none"> <li>With a Roller Lever</li> </ul> 	Possible *1 (Except for long-life models.)	Any of 4 directions	WLCA2-□S	WLMCA2□
General-purpose Overtravel	WLH□	<ul style="list-style-type: none"> <li>Overtravel is large, making setting the dog easier.</li> <li>Mounting is compatible with WLH2.</li> </ul> 	Not possible *2	Any of 4 directions	WLH2-□S	WLH2□
High-sensitivity Overtravel	WLG□	<ul style="list-style-type: none"> <li>Operation is highly sensitive with only 10° pretravel.</li> <li>Overtravel is large, making setting the dog easier.</li> <li>Mounting is compatible with WLG2.</li> </ul> 	Not possible *2	Any of 4 directions	WLG2-□S	WLMG2□
Overtravel, 90° operation	WL□-2	<ul style="list-style-type: none"> <li>Overtravel is large, making setting the dog easier.</li> <li>Mounting is compatible with WLCA2-2.</li> </ul> 	Not possible *2	Any of 4 directions	—	—
	WL□-2N		Possible *1	Either of 2 directions		
High-precision	WLGCA2	<ul style="list-style-type: none"> <li>Repeat accuracy is twice that basic models.</li> <li>Operation is highly sensitive with only 5° pretravel.</li> <li>Ideal for positioning, e.g.,</li> </ul> 	Possible *1	Any of 4 directions	WLGCA2-□S	WLMGCA2□
Maintained	WLCA32-□	<ul style="list-style-type: none"> <li>When the dog throws the lever, the output is reversed and the reversed output is held even after the dog passed. The original status is returned to only after the dog passed.</li> </ul> 	—	Any of 4 directions	—	—

\*1. One-side operation means that three operational directions can be selected electrically, according to the change in direction of the operating plunger. The operating plunger is set for operation on both sides before delivery.

\*2. Those models for which one-side operation is impossible can only operate on both sides.

Connectors and Conduits

Wiring type	General-purpose	Connector/conduit specifications	Spatter-prevention	Long-life
	Model		Model	Model
Direct-wired connector	WL□-□LDK□	• SC-2F/-4F Connector built-in	—	WLM□-LDK□
Pre-wired connector	WL□-□LD-M1□ WL□-□LD-□GJ□ WL□-□LD-DK1EJ□	• XS2H-series Pre-wired Connector built-in	WL□-□S-M1□J-1 WL□-□S-DGJS03	WLM□-LD-M1J WLM□-LD-□GJ□
Conduit (screw terminal)	WL□-□ WL□-□G1□ WL□-□G□ WL□-□Y□ WL□-□TS□	<ul style="list-style-type: none"> <li>G1/2 with no ground terminal</li> <li>G1/2 with ground terminal</li> <li>Pg13.5 with ground terminal</li> <li>M20 with ground terminal</li> <li>1/2 14NPT with ground terminal</li> </ul>	—	WLM□-LD — — — —

Environment-resistant Switches

Type	Item		Environment-resistant		
	Model	Application	Environment-resistant construction	Applicable models	
Airtight seal	WL□-55	For uses in locations subject to cutting oil or water	Uses the W-10FB3-55 Airtight Built-in Switch. Note: Use the SC Connector for the conduit opening.	All models except the low-temperature and heat-resistant models Note: Models can be produced using standard actuators.	
Hermetic seal (Molded terminals/ Anti-coolant)	WL□-139		Refer to page 25 for information on the environment-resistant construction of Switches with Hermetic Seals.		All models except the low-temperature and heat-resistant models Note: Models can be produced using standard actuators. Only the WLCA2, WLGCA2, or WLH2 can be produced for the WL□-141 and WL□-145.
	WL□-140				
	WL□-141				
	WL□-145				
	WL□-RP40				
	WL□-RP60				
Low-temperature *	WL□-TC	Can be used at a temperature of -40°C (operating temperature range: -40 to 40°C), but cannot withstand icing.	<ul style="list-style-type: none"> <li>• Uses a general-purpose built-in switch.</li> <li>• Silicone rubber is used for rubber parts such as the O-ring, gasket, etc.</li> </ul>	All models except airtight seal, hermetic seal, heat-resistant, corrosion-proof, and indicator-equipped models	
Heat-resistant *	WL□-TH	Can be used in temperatures of 120°C (operating temperature range: 5 to 120°C).	<ul style="list-style-type: none"> <li>• Uses a special built-in switch made from heat-resistant resin.</li> <li>• Silicone rubber is used for rubber parts such as the O-ring, gasket etc.</li> </ul>	All models except airtight seal, hermetic seal, heat-resistant, corrosion-proof, and indicator-equipped, nylon roller (WLCA2-26N), seal roller models, and resin rod (WLNJ-2) models	
Corrosion-proof	WL□-RP	For use in locations subject to corrosive gases and chemicals.	<ul style="list-style-type: none"> <li>• Diecast parts, such as the switch box, are made of corrosion-proof aluminum.</li> <li>• Rubber sealing parts are made of fluorine rubber which aids in resisting oil, chemicals and adverse weather conditions.</li> <li>• Exposed nuts and screws (except the actuator section) are made of stainless steel.</li> <li>• Moving and rotary parts such as rollers are made of sintered stainless steel or stainless steel.</li> <li>• The Head, box, and cover are yellow.</li> </ul>	All models except overtravel (90° operation), fork lever lock (WLCA32-41 to -43), low-temperature, heat-resistant, and indicator-equipped models	
Weather-proof *	WL□-P1	For use in parking lots and other outdoor locations.	<ul style="list-style-type: none"> <li>• Rubber parts are made from silicone rubber, which has a high-tolerance to deterioration over time and changes in temperature.</li> <li>• Rollers are made of stainless steel to improve corrosion resistance.</li> <li>• Exposed nuts and screws are made of stainless steel.</li> </ul>	Only basic (WLCA2/CA12/CL), general-purpose overtravel (WLH2/H12/HL) and high-sensitivity overtravel (WLG2/G12/GL) models (excluding heat-resistant models).	

\* Weather Resistance, Cold Resistance, and Heat Resistance



Silicon rubber is used to increase resistance to weather, cold, and heat. Silicon rubber, however, can generate silicon gas. (This can occur at room temperature, but the amount of silicon gas generated increases at higher temperatures.) Silicon gas will react as a result of arc energy and form silicon oxide (SiO<sub>2</sub>). If silicon oxide accumulates on the contacts, contact interference can occur and can interfere with the device. Before using a Switch, test it under actual application conditions (including the environment and operating frequency) to confirm that no problems will occur in actual.

### Selection Guide

With the WL Series, OMRON will combine the switch, Actuator, and wiring method required to build the ideal switch for your application.

**The WL Series consists of four basic types: General-purpose, Environment-resistant, Spatter-prevention, and Long-life Switches. WLCA2 Switches can be used for the most common applications.**

### According to Operating Environment

	Environment	Key specifications	Models
Ambient operating temperature	Normal	<p style="text-align: center;">-10°C                      +80°C</p>  <p>Water-resistant to IP67.</p>	<p>WL□    General-purpose Switches</p> <p>WLM□    Long-life Switches</p>
	High-temperature	<p style="text-align: center;">+5°C                                      +120°C</p>  <p>To increase heat resistance, the rubber material (silicon rubber) and the material of the built-in switch have been changed.</p>	<p>WL□-TH    Heat-resistant Switches *1</p>
	Low-temperature	<p style="text-align: center;">-40°C                                      +40°C</p>  <p>To increase resistance to cold, silicon rubber and other measures are used.</p>	<p>WL□-TC    Low-temperature Switches *1</p>
Operating environment	Outdoors	Rubber parts are made from silicone rubber, which has a high-tolerance to deterioration over time and changes in temperature. Rollers are made of stainless steel to improve corrosion resistance. Exposed nuts and screws are made of stainless steel.	<p>WL□-P1    Weather-proof Switches *1</p>
	Chemicals and oil	Corrosion-proof aluminum diecast has been used for the housing, fluorine rubber has been used for rubber parts, and stainless steel has been used for screws and nuts (except for actuator) to increase resistance to oils, chemicals, and weather.	<p>WL□-RP    Corrosion-proof Switches *1</p>
	Water drops and mist	Uses an airtight built-in switch.	<p>WL□-55    Airtight Switches *1</p>
	Constant water drops and mist	Cables attached. Uses a general-purpose built-in switch. The case cover and conduit opening are molded from epoxy resin to increase the seal. The cover cannot be removed.	<p>WL□-139 Hermetic, Molded-terminal Switches *1, *2</p>
		Cables attached. Uses an airtight built-in switch. The case cover and box interior are molded from epoxy resin to increase the seal. The cover cannot be removed. The SC connector can be removed, so it is possible to use flexible conduits for the cable.	<p>WL□-RP40 Hermetic, Molded-terminal Switches *1, *2</p>
		Cables attached. Uses an airtight built-in switch. The cover screws, case cover, box interior, and conduit opening are molded from epoxy resin to increase the seal. (The cover cannot be removed.)	<p>WL□-140 Hermetic, Molded-terminal Switches *1, *2</p>
	Constant water drops or splattering cutting powder	Cables attached. Uses an airtight built-in switch. The cover screws, case cover, box interior, conduit opening, box head, and head screws are molded from epoxy resin to increase the seal. (The cover cannot be removed.) The Head opening is protected from cutting powder. -141: The Head section is molded from epoxy resin; Head direction cannot be changed. -145: The Head section is molded from epoxy resin; Head can be in any of 4 directions.	<p>WL□-141, -145 Hermetic, Molded-terminal Switches *1, *2 (Only the WLCA2, WLG2, WLGA2, and WLH2 can be produced.)</p>
Coolant	Cables attached. Uses an airtight built-in switch. The case cover, box interior, conduit opening, and head screws are molded from epoxy resin to increase the seal. (The cover cannot be removed.) Rubber parts are made from fluorine rubber to increase resistance to coolant.	<p>WL□-RP60 Hermetic, Molded-terminal Switches *1, *2</p>	
Spattering from welding	To prevent spatter during welding, a heat-resistant resin is used for the indicator cover and screws and rollers are all made from stainless steel.	<p>WL□-S    Spatter-prevention Switches</p>	

\*1. Not all functions can be combined with environment-resistant switches. Refer to the applicable models on the previous page.

\*2. Refer to page 25 for information on the construction of Hermetic Switches.











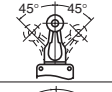

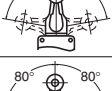

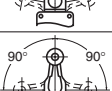

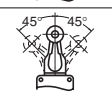

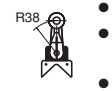







### According to Application Conditions

	Conditions	Key specifications	Models	
Load	Switching standard loads	10 A at 125,250, or 500 VAC 0.8 A at 125 VDC 0.4 A at 250 VDC	WL□ WL□-S WLM□	General-purpose Switches Spatter-prevention Switches Long-life Switches
	Switching microloads	0.1 A at 125 VAC, resistive load 0.1 A at 30 VDC, resistive load	WL01□ WL01□-S	General-purpose Microload Switches Spatter-prevention Microload Switches
Durability	Normal durability	Mechanical: 15 million operation min. (10 million operation min. for overtravel general-purpose or high-sensitivity models or flexible rod models)	WL□ WL□-S	General-purpose Switches Spatter-prevention Switches
	Long-life	Mechanical: 30 million operation min.	WLM□	Long-life Switches

### According to Ease of Installation and Maintenance

	Conditions	Key specifications	Models	
Operation indicator	Daily inspections and maintenance checks	Switching light-ON between operating/not operating. (Switching not possible for models with molded terminals.) Neon lamp 125 to 250 VAC	WL□-LE WL□-LES	General-purpose, Indicator-equipped (Neon Lamp) Switches Spatter-prevention, Indicator-equipped (Neon Lamp) Switches
		Switching light-ON between operating/not operating. (Switching not possible for models with molded terminals.) LED 10 to 115 VAC/DC	WL□-LD WL□-LDS	General-purpose, Indicator-equipped (LED) Switches Spatter-prevention, Indicator-equipped (LED) Switches
Wiring specification	Screw tightening and installation	Screw terminals. No ground terminal. Conduit size: G1/2	WL□ WLM□	General-purpose Switches Long-life Switches
		Screw terminals. Ground terminal. Conduit size: 4 sizes	WL□	General-purpose Switches
	One-touch connector attachment	Direct-wired connector, 2-conductor. Greatly reduces wiring work. Water-proof to IP67.	WL□-□LDK13 WLM□-LDK13	General-purpose, Direct-wired Connector Switches Long-life, Direct-wired Connector Switches
		Direct-wired connector, 4-conductor. Greatly reduces wiring work. Water-proof to IP67.	WL□-□LDK43 WLM□-LDK43	General-purpose, Direct-wired Connector Switches Long-life, Direct-wired Connector Switches
	Connector attachment in control and relay boxes	Pre-wired connector, 2-conductor. Greatly reduces wiring work. Water-proof to IP67.	WL□-□LD-M1J WL□-□S-M1J-1 WLM□-LD-M1J	General-purpose, Pre-wired Connector Switches Spatter-prevention, Pre-wired Connector Switches Long-life, Pre-wired Connector Switches
		Pre-wired connector, 4-conductor. Greatly reduces wiring work. Water-proof to IP67.	WL□-□LD-□GJO3 WL□-□S-□GJSO3 WLM□-LD-□GJO3	General-purpose, Pre-wired Connector Switches Spatter-prevention, Pre-wired Connector Switches Long-life, Pre-wired Connector Switches

According to Form of Operation

Detection object	Key specifications		Models	
Operation angles	General	TT (total travel)  PT (pretravel) 	WLCA2 WLCA2-□S WLMCA2	General-purpose Switches Spatter-prevention Switches Long-life Switches
	Passing dogs	 	WLH2 WLH2-□S WLMH2	General-purpose Switches Spatter-prevention Switches Long-life Switches
	Passing dogs, high sensitivity	 	WLG2 WLG2-□S WLMG2	General-purpose Switches Spatter-prevention Switches Long-life Switches
	Passing dogs	 WLCA2-2  WLCA2-2N 	WLCA2-2 WLCA2-2N	General-purpose Switches General-purpose Switches
	High precision	 	WLGCA2 WLGCA2-□S WLMGCA2	General-purpose Switches Spatter-prevention Switches Long-life Switches
Actuators	Dogs and workpieces (Mounts in any of 4 directions)	 ● Short lever ● One-Horizontal operation possible. (WLCA□ only) ● Head mounts in any of 4 directions.	WL□2 WL□2-□S WLM□2	Roller Lever Actuators Roller Lever Actuators Roller Lever Actuators
		 ● Medium lever ● One-Horizontal operation possible. (WLCA□ only) ● Head mounts in any of 4 directions.	WL□2-7	Roller Lever Actuators
		 ● Long lever ● One-Horizontal operation possible. (WLCA□ only) ● Head mounts in any of 4 directions.	WL□2-8	Roller Lever Actuators
	Adjustable between dog and lever	 ● One-Horizontal operation possible. (WLCA□ only) ● Head mounts in any of 4 directions.	WL□12	Adjustable Roller Lever Actuators
	Dogs or workpieces with large deflection	 ● One-Horizontal operation possible. (WLCL only) ● Head mounts in any of 4 directions.	WL□L	Adjustable Rod Lever Actuators
		 ● One-Horizontal operation not possible. ● Head mounts in any of 4 directions.	WLHAL4	Adjustable Rod Lever Actuator
		 ● One-Horizontal operation not possible. ● Head mounts in any of 4 directions.	WLHAL5	Rod Spring Lever Actuator
	Round-trip operation of passing dogs	 ● Head mounts in any of 4 directions.	WLCA32-41	Fork Lever Lock Actuator
		 ● Head mounts in any of 4 directions.	WLCA32-42	Fork Lever Lock Actuator
		 ● Head mounts in any of 4 directions.	WLCA32-43	Fork Lever Lock Actuator
 ● Head mounts in any of 4 directions.		WLCA32-44	Fork Lever Lock Actuator	
Cams or workpieces with vertical movement		WLD	Top Plunger Actuator	
	 ● Head mounts in any of 4 directions.	WLSD	Horizontal Plunger Actuator	
		WLD3	Top-ball Plunger Actuator	
	 ● Head mounts in any of 4 directions.	WLSD3	Horizontal-ball Plunger Actuator	
	 ● Available in sealed models. (WLD28□)	WLD2 WLD28	Top-roller Plunger Actuator Sealed Top-roller Plunger Actuator	
		WLSD2	Horizontal-roller Plunger Actuator	



Application Examples

Positioning on Production Lines

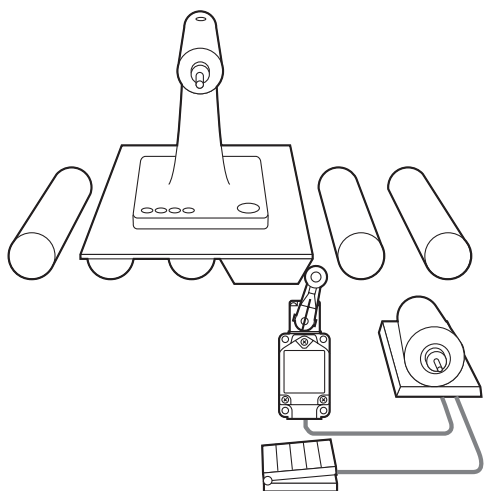

High-precision Positioning of Machine Tools

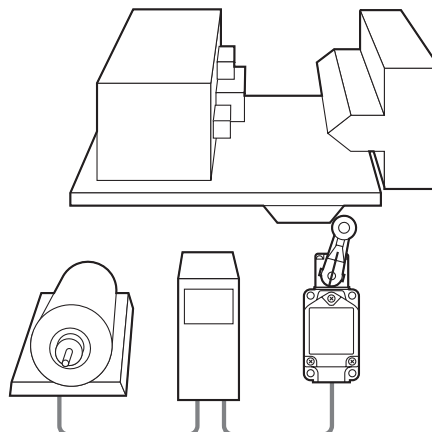

Positioning on Suspended Conveyors

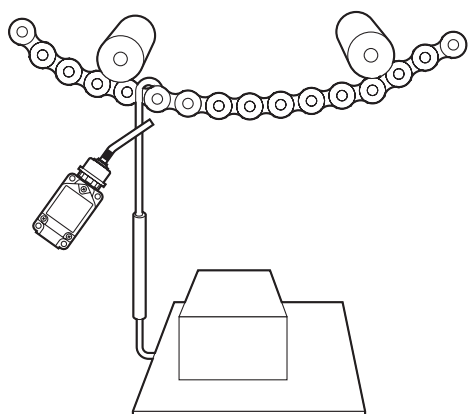

Pallet Detection in Arc Welding Lines

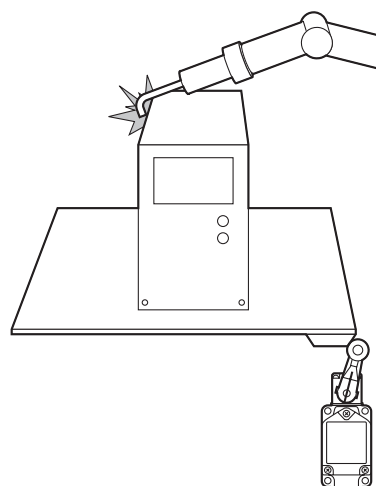

Multilevel Car Parking Towers

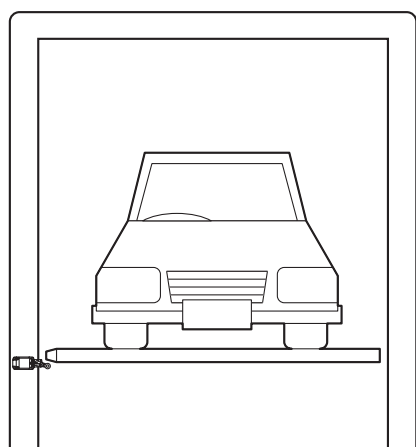

Limit Detection in Transport Systems

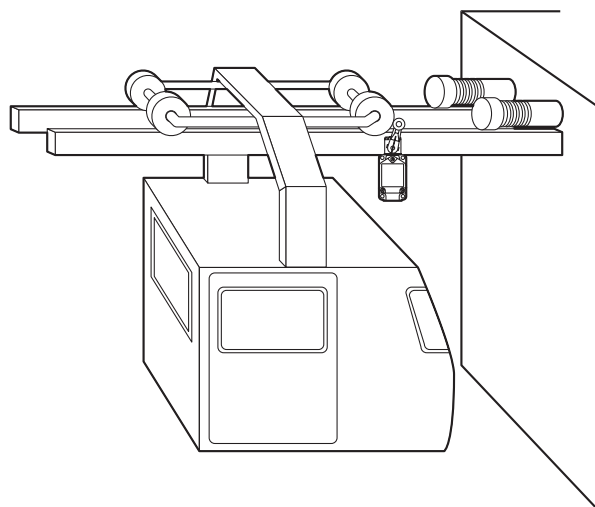

## Model Number Structure

**Model Number Legend** (Not all combinations are possible. Ask your OMRON representative for details.)

### General-purpose and Environment-resistant Switches

WL □□-□□□□□□□□  
(1) (2) (3) (4) (5) (6) (7) (8) (9) (10)

#### (1) Electrical Rating

Blank	Standard load
01	Microload

Note: Dimensions are the same as the standard models.

#### (3) Environment-resistant Model Specifications

Blank	Standard
RP	Corrosion-proof *1
P1	Weather-proof *1

Note: Dimensions are the same as the standard models.

\*1. Refer to page 4 for applicable models.

#### (4) Built-in Switch Type

Blank	Standard
55	Hermetically sealed *1

Note: Dimensions are the same as the standard models.

\*1. Refer to page 4 for applicable models.

#### (5) Temperature Specifications

Blank	Standard: -10°C to +80°C
TH	Heat-resistant: +5°C to +120°C *1
TC	Low-temperature: -40°C to +40°C *1

Note: Dimensions are the same as the standard models.

\*1. Refer to page 4 for applicable models.

#### (7) Conduit Size, Ground Terminal Specifications \*2

Blank	G1/2 without ground terminal
G1	G1/2 with ground terminal
G	Pg13.5 with ground terminal
Y	M20 with ground terminal
TS	1/2-14NPT with ground terminal

Note: Dimensions are the same as the standard models.

\*2. Models with ground terminals are approved by EN/IEC (CE marking).

#### (6) Hermetic Model Specifications

Blank	No cables or molding
139	General-purpose built-in switch with cables attached and molded conduit opening and cover (cover cannot be removed). *
140	Airtight built-in switch with cables attached and molded conduit opening, cover, and box interior cover screws (cover cannot be removed). *
141	Airtight built-in switch with cables attached and molded conduit opening, cover, head, box interior, cover screws, and head screws (cover cannot be removed, Head direction cannot be changed). The Head opening is created to protect it from cutting powder. *
145	Airtight built-in switch with cables attached and molded conduit opening, cover, box interior, and cover screws (cover cannot be removed, Head can be mounted in any of 4 directions). The Head opening is created to protect it from cutting powder. *
RP40	Airtight built-in switch with cables attached and molded cover and box interior (cover cannot be removed, Head direction can be changed). SC Connector can be removed, so it is possible to use flexible conduits for the cable. *
RP60	Airtight built-in switch with cables attached, fluorine rubber used, and molded conduit opening, cover, and box interior (cover cannot be removed, Head direction cannot be changed). *

\* Refer to page 4 for applicable models.

#### (2) Actuator and Head Specifications

Symbol	Actuator type	Switch without lever
CA2	Roller lever: Standard model R38	WLCA2
CA2-7	Roller lever: Standard model R50	WLCA2
CA2-8	Roller lever: Standard model R63	WLCA2
H2	Roller lever: General-purpose overtravel model, 80°	WLRH2
G2	Roller lever: High-sensitivity overtravel, 80°	WLRG2
CA2-2	Roller lever: Overtravel, 90°	WLCA2-2
CA2-2N	Roller lever: Overtravel, 90°	WLCA2-2N
GCA2	Roller lever: High-precision R38	WLRGCA2
CA12	Adjustable roller lever: Standard	WLCA2
H12	Adjustable roller lever: General-purpose overtravel model, 80°	WLRH2
G12	Adjustable roller lever: High-sensitivity overtravel, 80°	WLRG2
CA12-2	Adjustable roller lever: Overtravel, 90°	WLCA2-2
CA12-2N	Adjustable roller lever: Overtravel, 90°	WLCA2-2N
CL	Adjustable rod lever: Standard, 25 to 140 mm	WLRCL
HL	Adjustable rod lever: General-purpose overtravel model, 80°, 25 to 140 mm	WLRH2
HAL4	Adjustable rod lever: General-purpose overtravel model, 80°, 350 to 380 mm	WLRH2
GL	Adjustable rod lever: High-sensitivity overtravel, 80°, 25 to 140 mm	WLRG2
CL-2	Adjustable rod lever: Overtravel, 90°, 25 to 140 mm	WLCA2-2
CL-2N	Adjustable rod lever: Overtravel, 90°, 25 to 140 mm	WLCA2-2N
HAL5	Rod spring lever: General-purpose overtravel model, 80°	WLRH2
CA32-41	Fork lever lock: Maintained, WL-5A100	WLCA32
CA32-42	Fork lever lock: Maintained, WL-5A102	WLCA32
CA32-43	Fork lever lock: Maintained, WL-5A104	WLCA32
D	Plunger: Top plunger	—
D2	Plunger: Top-roller plunger	—
D28	Plunger: Sealed top-roller plunger	—
D3	Plunger: Top-ball plunger	—
SD	Plunger: Horizontal plunger	—
SD2	Plunger: Horizontal-roller plunger	—
SD3	Plunger: Horizontal-ball plunger	—
NJ	Flexible rod: Coil spring	—
NJ-30	Flexible rod: Coil spring, multi-wire	—
NJ-2	Flexible rod: Coil spring, resin rod	—
NJ-S2	Flexible rod: Steel wire	—

#### (8) Indicator Type

Symbol	Element	Voltage	Leakage current
Blank	No indicator		
LE	Neon lamp	125 to 250 VAC	Approx. 0.6 to 1.9 mA
LD	LED	115 VAC/VDC	Approx. 0.5 mA
		10 to 24 VAC/VDC	Approx. 0.4 mA

Note: Dimensions are the same for both LE and LD models.

#### (9) Indicator Wiring

2	NC connection: Light-ON when operating
3	NO connection: Light-ON when not operating

Note: Include the indicator wiring specification only when a (6) hermetic seal and (8) operation indicator have been selected.

#### (10) Lever Type

Blank	Standard lever
A	Double nut lever

**General-purpose Switches**

**Sensor I/O Connector Switches**

WL □□-□□ LD □□  
(1) (2) (3) (4) (5)

**(1) Electrical Rating**

<b>Blank</b>	Standard load
<b>01</b>	Microload

Note: Dimensions are the same as the standard models.

**(2) Actuator Type**

<b>CA2</b>	Roller lever: Standard model
<b>GCA2</b>	Roller lever: High-precision model
<b>H2</b>	Roller lever: General-purpose overtravel model
<b>G2</b>	Roller-lever: High-sensitivity overtravel model
<b>D2</b>	Top-roller plunger
<b>D28</b>	Sealed top-roller plunger

**(3) Built-in Switch Type**

<b>Blank</b>	Standard
<b>55</b>	Hermetically sealed

Note: Dimensions are the same as the standard models.

**Spatter-prevention Switches**

WL □□-□□ S □□  
(1) (2) (3) (4) (5)

**(1) Electrical Rating**

<b>Blank</b>	Standard load
<b>01</b>	Microload

Note: Dimensions are the same as the standard models.

**(2) Actuator Type**

<b>CA2</b>	Roller lever: Standard model
<b>GCA2</b>	Roller lever: High-precision model
<b>H2</b>	Roller lever: General-purpose Overtravel model
<b>G2</b>	Roller lever: High-sensitivity Overtravel model
<b>D28</b>	Sealed top-roller plunger

**(3) Built-in Switch Type**

<b>Blank</b>	Standard
<b>55</b>	Hermetically sealed

Note: Dimensions are the same as the standard models.

**(4) Indicator Type**

<b>LD</b>	LED, AC/DC
<b>LE</b>	Neon lamp

Note: Dimensions are the same for both LE and LD models.

**(5) Wiring Specifications**

<b>Blank</b>	Screw terminal: G1/2 conduit
<b>-M1J-1 *1</b>	Pre-wired Connector *2 (2-conductor: DC, NO wiring, connector pins No. 3, 4)
<b>-M1GJ-1 *1</b>	Pre-wired Connector *2 (2-conductor: DC, NO wiring, connector pins No. 1, 4)
<b>-DGJS03 *1</b>	Pre-wired Connector *2 (4-conductor: DC)

\*1. Models with pre-wired connectors and DC specifications are approved by EN/IEC (CE marking) except for LE Models (Neon Lamp Models).

\*2. With 0.3-m cable attached.

**Direct-wired Connector**



**Pre-wired Connector**

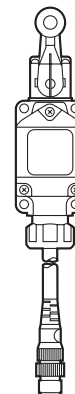

**(4) Indicator Type**

<b>LD</b>	LED, 10 to 115 VAC/DC
-----------	-----------------------

**(5) Wiring Specifications**

<b>K13A</b>	Direct-wired Connector (2-conductor: AC, NO wiring, connector pins No. 3, 4)
<b>K13</b>	Direct-wired Connector (2-conductor: DC, NO wiring, connector pins No. 3, 4)
<b>K43A</b>	Direct-wired Connector (4-conductor: AC)
<b>K43</b>	Direct-wired Connector (4-conductor: DC)
<b>-M1J *1</b>	Pre-wired Connector *2 (2-conductor: DC, NO wiring, connector pins No. 3, 4)
<b>-M1GJ *1</b>	Pre-wired Connector *2 (2-conductor: DC, NO wiring, connector pins No. 1, 4)
<b>-M1JB</b>	Pre-wired Connector *2 (2-conductor: DC, NC wiring, connector pins No. 3, 2)
<b>-AGJ03</b>	Pre-wired Connector *2 (4-conductor, AC)
<b>-DGJ03 *1</b>	Pre-wired Connector *2 (4-conductor, DC)
<b>-DK1EJ03 *1</b>	Pre-wired Connector *2 (3-conductor: DC, NO wiring, connector pins No. 2, 3, 4)

\*1. Models with pre-wired connectors and DC specifications have EN/IEC approval (CE marking).

\*2. With 0.3-m cable attached.

**Long-life Switches**

WLM □ -LD □□  
(1) (2) (3)

**(1) Actuator**

<b>CA2</b>	Roller lever: Standard model
<b>GCA2</b>	Roller lever: High-precision model
<b>H2</b>	Roller lever: General-purpose overtravel model
<b>G2</b>	Roller lever: High-sensitivity overtravel model

**(2) Indicator Type**

<b>LD</b>	LED, 10 to 115 VAC/DC
-----------	-----------------------

**(3) Wiring Specifications**

<b>Blank</b>	Screw terminal: G1/2 conduit
<b>K13A</b>	Direct-wired Connector: 2-conductor, AC
<b>K13</b>	Direct-wired Connector: 2-conductor, DC
<b>K43A</b>	Direct-wired Connector: 4-conductor, AC
<b>K43</b>	Direct-wired Connector: 4-conductor, DC
<b>-M1J</b>	Pre-wired Connector: 2-conductor, DC *
<b>-AGJ03</b>	Pre-wired Connector: 4-conductor, AC *
<b>-DGJ03</b>	Pre-wired Connector: 4-conductor, DC *

\* With 0.3-m cable attached.



## Ordering Information





### General-purpose Switches





#### Standard Switches

Note: Models are also available with ground terminals.





#### Lever



Item		Actuator	Roller lever R38 	Roller lever R50 	Roller lever R63 
			Model	Model	Model
Basic	Standard load		WLCA2	WLCA2-7	WLCA2-8
	Microload		WL01CA2	WL01CA2-7	WL01CA2-8
Overtravel	General-purpose	Standard load	WLH2	—	—
		Microload	WL01H2	—	—
	High-sensitivity	Standard load	WLG2	—	—
		Microload	WL01G2	—	—
	90° operation	Standard load	WLCA2-2	—	—
		Microload	WL01CA2-2	—	—
		Standard load	WLCA2-2N	—	—
		Microload	WL01CA2-2N	—	—
High-precision	Standard load	WLGCA2	—	—	
	Microload	WL01GCA2	—	—	

Item		Actuator	Adjustable roller lever 	Adjustable rod lever 25 to 140mm 	Adjustable rod lever 350 to 380mm 	Rod spring lever 
			Model	Model	Model	Model
Basic	Standard load		WLCA12	WLCL	—	—
	Microload		WL01CA12	WL01CL	—	—
Overtravel	General-purpose	Standard load	WLH12	WLHL	WLHAL4	WLHAL5
		Microload	WL01H12	WL01HL	—	—
	High-sensitivity	Standard load	WLG12	WLGL	—	—
		Microload	WL01G12	WL01GL	—	—
	90° operation	Standard load	WLCA12-2	WLCL-2	—	—
		Microload	WL01CA12-2	—	—	—
		Standard load	WLCA12-2N	WLCL-2N	—	—
		Microload	WL01CA12-2N	WL01CL-2N	—	—





Item		Actuator	Fork lever lock (with WL-5A100 plastic roller lever) 	Fork lever lock (with WL-5A102 plastic roller lever) 	Fork lever lock (with WL-5A104 plastic roller lever) 	Fork lever lock (with WL-5A104 plastic roller lever) 
			Model	Model	Model	Model
Maintained	Standard load		WLCA32-41	WLCA32-42	WLCA32-43	WLCA32-44
	Microload		WL01CA32-41	—	WL01CA32-43	WL01CA32-44

#### Plunger

Item		Actuator	Top plunger 	Top-roller plunger 	Top-ball plunger 	Sealed top-roller plunger 
			Model	Model	Model	Model
Top plunger	Standard load		WLD	WLD2	WLD3	WLD28
	Microload		WL01D	WL01D2	WL01D3	WL01D28

Item		Actuator	Horizontal plunger 	Horizontal-roller plunger 	Horizontal-ball plunger 
			Model	Model	Model
Side plunger	Standard load		WLS D	WLS D2	WLS D3
	Microload		WL01SD	WL01SD2	WL01SD3





#### Flexible Rod



Item		Actuator	Coil spring (spring diameter: 6.5) 	Coil spring (spring diameter: 4.8) 	Coil spring (resin rod diameter: 8) 	Steel wire (wire diameter: 1) 
			Model	Model	Model	Model
Flexible rod	Standard load		WLNJ	WLNJ-30	WLNJ-2	WLNJ-S2
	Microload		WL01NJ	WL01NJ-30	WL01NJ-2	WL01NJ-S2



General-purpose Switches

Indicator-equipped Switches





Lever



Item		Actuator	Roller lever R38 	Roller lever R50 	Roller lever R63 	Adjustable roller lever 
			Model	Model	Model	Model
Basic	Neon lamp		WLCA2-LE	WLCA2-7LE	WLCA2-8LE	WLCA12-LE
	LED		WLCA2-LD	WLCA2-7LD	WLCA2-8LD	WLCA12-LD
Overtravel	General-purpose	Neon lamp	WLH2-LE	—	—	WLH12-LE
		LED	WLH2-LD	—	—	WLH12-LD
	High-sensitivity	Neon lamp	WLG2-LE	—	—	WLG12-LE
		LED	WLG2-LD	—	—	WLG12-LD
	90° operation	Neon lamp	WLCA2-2LE	—	—	WLCA12-2LE
		LED	WLCA2-2LD	—	—	WLCA12-2LD
		Neon lamp	WLCA2-2NLE	—	—	WLCA12-2NLE
		LED	WLCA2-2NLD	—	—	WLCA12-2NLD
High-precision	Neon lamp	WLGCA2-LE	—	—	—	
	LED	WLGCA2-LD	—	—	—	

Item		Actuator	Adjustable rod lever 25 to 140 mm 	Adjustable rod lever 350 to 380 mm 	Rod spring lever 
			Model	Model	Model
Basic	Neon lamp		WLCL-LE	—	—
	LED		WLCL-LD	—	—
Overtravel	General-purpose	Neon lamp	WLHL-LE	WLHAL4-LE	WLHAL5-LE
		LED	WLHL-LD	WLHAL4-LD	WLHAL5-LD
	High-sensitivity	Neon lamp	WLGL-LE	—	—
		LED	WLGL-LD	—	—
	90° operation	Neon lamp	WLCL-2LE	—	—
		LED	WLCL-2LD	—	—
		Neon lamp	WLCL-2NLE	—	—
		LED	WLCL-2NLD	—	—





Item		Actuator	Fork lever lock (with WL-5A100 Plastic Roller Lever) 	Fork lever lock (with WL-5A102 Plastic Roller Lever) 	Fork lever lock (with WL-5A104 Plastic Roller Lever) 
			Model	Model	Model
Maintained	Neon lamp		WLCA32-41LE	WLCA32-42LE	WLCA32-43LE
	LED		WLCA32-41LD	—	WLCA32-43LD

Plunger

Item		Actuator	Top plunger 	Top-roller plunger 	Top-ball plunger 	Sealed top-roller plunger 
			Model	Model	Model	Model
Top plunger	Neon lamp		WLD-LE	WLD2-LE	WLD3-LE	WLD28-LE
	LED		WLD-LD	WLD2-LD	WLD3-LD	WLD28-LD

Item		Actuator	Horizontal plunger 	Horizontal-roller plunger 	Horizontal-ball plunger 
			Model	Model	Model
Side plunger	Neon lamp		WLS2-LE	WLS2-LE	WLS3-LE
	LED		WLS2-LD	WLS2-LD	WLS3-LD



Flexible Rod

Item		Actuator	Coil spring (spring diameter: 6.5) 	Coil spring (spring diameter: 4.8) 	Coil spring (resin rod diameter: 8) 	Steel wire (wire diameter: 1) 
			Model	Model	Model	Model
Flexible rod	Neon lamp		WLNJ-LE	WLNJ-30LE	WLNJ-2LE	WLNJ-S2LE
	LED		WLNJ-LD	WLNJ-30LD	WLNJ-2LD	WLNJ-S2LD



General-purpose Switches

Sensor I/O Connector Switches

Direct-wired Connectors

Actuator	Wiring				Item	Basic	Overtravel		High-precision
							General-purpose	High-sensitivity	
	Model	Model	Model	Model					
	2-conductor	DC	NO	connector pins No. 3, 4	Standard	WLCA2-LDK13	WLH2-LDK13	WLG2-LDK13	WLGCA2-LDK13
					Airtight seal	WLCA2-55LDK13	WLH2-55LDK13	WLG2-55LDK13	WLGCA2-55LDK13
	4-conductor	DC			Standard	WLCA2-LDK43	WLH2-LDK43	WLG2-LDK43	WLGCA2-LDK43
					Airtight seal	WLCA2-55LDK43	WLH2-55LDK43	WLG2-55LDK43	WLGCA2-55LDK43
	2-conductor	DC	NO	connector pins No. 3, 4	Standard	WLD2-LDK13	—	—	—
					Airtight seal	WLD2-55LDK13	—	—	—
	4-conductor	DC			Standard	WLD2-LDK43	—	—	—
					Airtight seal	WLD2-55LDK43	—	—	—

Pre-wired Connectors

Actuator	Wiring				Item	Basic	Overtravel		High-precision
							General-purpose	High-sensitivity	
	Model	Model	Model	Model					
	2-conductor	DC	NO	connector pins No. 3, 4	Standard	WLCA2-LD-M1J	WLH2-LD-M1J	WLG2-LD-M1J	WLGCA2-LD-M1J
					Airtight seal	WLCA2-55LD-M1J	—	—	WLGCA2-55LD-M1J
				connector pins No. 1, 4	Standard	WLCA2-LD-M1GJ	WLH2-LD-M1GJ	WLG2-LD-M1GJ	WLGCA2-LD-M1GJ
			Airtight seal		WLCA2-55LD-M1GJ	—	WLG2-55LD-M1GJ	—	
			NC	connector pins No. 3, 2	Standard	—	—	WLG2-LD-M1JB	—
					Airtight seal	WLCA2-55LD-M1JB	—	WLG2-55LD-M1JB	WLGCA2-55LD-M1JB
	4-conductor	DC			Standard	WLCA2-LD-DGJ03	WLH2-LD-DGJ03	WLG2-LD-DGJ03	—
					Airtight seal	WLCA2-55LD-DGJ03	—	WLG2-55LD-DGJ03	WLGCA2-55LD-DGJ03
	3-conductor	DC		connector pins No. 2, 3, 4	Standard	WLCA2-LD-DK1EJ03	—	WLG2-LD-DK1EJ03	—
					Airtight seal	WLCA2-55LD-DK1EJ03	—	WLG2-55LD-DK1EJ03	—
	2-conductor	DC	NO	connector pins No. 3, 4	Standard	WLD2-LD-M1J	—	—	—
					Airtight seal	WLD2-55LD-M1J	—	—	—
				connector pins No. 1, 4	Standard	WLD2-LD-M1GJ	—	—	—
			Airtight seal		WLD2-55LD-M1GJ	—	—	—	
			NC	connector pins No. 3, 2	Standard	—	—	—	—
					Airtight seal	WLD2-55LD-M1JB	—	—	—
	4-conductor	DC			Standard	WLD2-LD-DGJ03	—	—	—
					Airtight seal	—	—	—	—
	3-conductor	DC		connector pins No. 2, 3, 4	Standard	WLD2-LD-DK1EJ03	—	—	—
					Airtight seal	WLD2-55LD-DK1EJ03	—	—	—

**Environment-resistant Switches**

Note: Models are also available with ground terminals.

Item			Actuator	Roller lever R38 			
				Basic	Overtravel		
					General-purpose	High-sensitivity	
			Model	Model	Model		
Airtight seal			No indicator		WLCA2-55	WLH2-55	WLG2-55
			Indicator	LED	WLCA2-55LD	WLH2-55LD	WLG2-55LD
				Neon	WLCA2-55LE	WLH2-55LE	WLG2-55LE
Hermetic seal	Molded terminals	-139	No indicator		WLCA2-139	WLH2-139	WLG2-139
			Indicator	NC wiring	WLCA2-139LD2	—	—
				NO wiring	WLCA2-139LD3	—	WLG2-139LD3
		-140	No indicator		WLCA2-140	WLH2-140	WLG2-140
			Indicator	NC wiring	WLCA2-140LD2	—	WLG2-140LD2
				NO wiring	WLCA2-140LD3	—	WLG2-140LD3
	-141	No indicator		WLCA2-141	WLH2-141	WLG2-141	
		Indicator	NC wiring	WLCA2-141LD2	—	WLG2-141LD2	
			NO wiring	WLCA2-141LD3	WLH2-141LD3	WLG2-141LD3	
	Anti-coolant		No indicator		WLCA2-RP60	WLH2-RP60	WLG2-RP60
			Indicator	NC wiring	WLCA2-RP60LD2	—	WLG2-RP60LD2
				NO wiring	WLCA2-RP60LD3	WLH2-RP60LD3	WLG2-RP60LD3
Heat-resistant			No indicator	WLCA2-TH	WLH2-TH	WLG2-TH	
Low-temperature				WLCA2-TC	WLH2-TC	WLG2-TC	
Corrosion-proof				WLCA2-RP	WLH2-RP	WLG2-RP	
Weather-proof				WLCA2-P1	WLH2-P1	WLG2-P1	

Item			Actuator	Roller lever R38 			
				Overtravel		High-precision	
				90° (-2 model)	90° (-2N model)		
			Model	Model	Model		
Airtight seal			No indicator		WLCA2-255	WLCA2-2N55	WLGCA2-55
			Indicator	LED	WLCA2-255LD	WLCA2-2N55LD	WLGCA2-55LD
				Neon	WLCA2-255LE	WLCA2-2N55LE	WLGCA2-55LE
Hermetic seal	Molded terminals	-139	No indicator		WLCA2-2139	WLCA2-2N139	WLGCA2-139
			Indicator	NC wiring	WLCA2-2139LD2	—	WLGCA2-139LD2
				NO wiring	WLCA2-2139LD3	—	WLGCA2-139LD3
		-140	No indicator		—	WLCA2-2N140	WLGCA2-140
			Indicator	NC wiring	—	—	WLGCA2-140LD2
				NO wiring	—	—	WLGCA2-140LD3
	-141	No indicator		—	—	WLGCA2-141	
		Indicator	NC wiring	—	—	—	
			NO wiring	—	—	WLGCA2-141LD3	
	Anti-coolant		No indicator		WLCA2-2RP60	—	WLGCA2-RP60
			Indicator	NC wiring	WLCA2-2RP60LD2	—	WLGCA2-RP60LD2
				NO wiring	WLCA2-2RP60LD3	—	WLGCA2-RP60LD3
Heat-resistant			No indicator	WLCA2-2TH	WLCA2-2NTH	WLGCA2-TH	
Low-temperature				WLCA2-2TC	WLCA2-2NTC	WLGCA2-TC	
Corrosion-proof				—	—	WLGCA2-RP	



Actuator			Adjustable roller lever 								
			Basic	Overtravel							
				General-purpose	High-sensitivity						
Item			Model	Model	Model						
Airtight seal			No indicator			WLCA12-55	—	—			
			Indicator		LED	WLCA12-55LD	—	—			
					Neon	WLCA12-55LE	—	—			
Hermetic seal			No indicator			WLCA12-139	—	—			
						Molded terminals		-139	WLCA12-140	—	—
								-140	WLCA12-141	—	—
						Anti-coolant		-141	WLCA12-RP60	—	—
Heat-resistant			No indicator			WLCA12-TH	WLH12-TH	WLG12-TH			
Low-temperature						WLCA12-TC	WLH12-TC	WLG12-TC			
Corrosion-proof						WLCA12-RP	WLH12-RP	WLG12-RP			
Weather-proof						WLCA12-P1	WLH12-P1	WLG12-P1			

Actuator			Adjustable roller lever 			
			Overtravel			
			90° (-2 model)	90° (-2N model)		
Item			Model	Model		
Heat-resistant			No indicator		WLCA12-2TH	WLCA12-2NTH
Low-temperature					WLCA12-2TC	WLCA12-2NTC



Actuator			Adjustable rod lever 25 to 140 mm 								
			Basic	Overtravel							
				General-purpose	High-sensitivity						
Item			Model	Model	Model						
Airtight seal			No indicator			WLCL-55	—	—			
			Indicator		LED	WLCL-55LD	—	—			
					Neon	—	—	—			
Hermetic seal			No indicator			WLCL-139	—	—			
						Molded terminals		-139	WLCL-140	—	—
								-140	—	—	—
						Anti-coolant		-141	WLCL-RP60	—	—
Heat-resistant			No indicator			WLCL-TH	WLHL-TH	WLGL-TH			
Low-temperature						WLCL-TC	WLHL-TC	WLGL-TC			
Corrosion-proof						WLCL-RP	WLHL-RP	WLGL-RP			
Weather-proof						WLCL-P1	WLHL-P1	WLGL-P1			

Actuator			Adjustable rod lever 25 to 140 mm 			
			Overtravel			
			90° (-2 model)	90° (-2N model)		
Item			Model	Model		
Heat-resistant			No indicator		WLCL-2TH	WLCL-2NTH
Low-temperature					WLCL-2TC	WLCL-2NTC
Corrosion-proof					WLCL-2RP	—







Item			Actuator		Top-roller plunger 	Sealed top-roller plunger 	Horizontal plunger 
			No indicator		Model	Model	Model
Airtight seal	No indicator		LED		WLD2-55	WLD28-55	WLSD-55
			Neon		WLD2-55LD	WLD28-55LD	WLSD-55LD
	Indicator		Neon		WLD2-55LE	WLD28-55LE	—
Hermetic seal	Molded terminals	-139	No indicator		WLD2-139	WLD28-139	WLSD-139
		-140			—	WLD28-140	—
	Anti-coolant				WLD2-RP60	WLD28-RP60	WLSD-RP60
Heat-resistant			No indicator		WLD2-TH	WLD28-TH	WLSD-TH
Low-temperature					WLD2-TC	—	WLSD-TC
Corrosion-proof					WLD2-RP	WLD28-RP	WLSD-RP

Note: The standard cable length for models with airtight seals is 5 m.

Item			Actuator		Horizontal-roller plunger 	Coil spring (spring diameter: 6.5) 	Coil spring (resin rod diameter: 8) 
			No indicator		Model	Model	Model
Airtight seal	No indicator		LED		WLSD2-55	WLNJ-55	WLNJ-255
			Neon		WLSD2-55LD	WLNJ-55LD	WLNJ-255LD
	Indicator		Neon		—	—	—
Hermetic seal	Molded terminals	-139	No indicator		WLSD2-139	WLNJ-139	—
		-140			WLSD2-140	WLNJ-140	WLNJ-2140
	Anti-coolant				WLSD2-RP60	WLNJ-RP60	WLNJ-2RP60
Heat-resistant			No indicator		WLSD2-TH	WLNJ-TH	—
Low-temperature					WLSD2-TC	WLNJ-TC	WLNJ-2TC
Corrosion-proof					WLSD2-RP	WLNJ-RP	WLNJ-2RP



Note: The standard cable length for models with airtight seals is 5 m.

**Spatter-prevention Switches**

Item		Actuator		Roller lever 		Sealed top-roller plunger 
				Double nut lever 	Allen-head lever 	
				Model	Model	Model
Neon lamp operation indicator	Basic			WLCA2-LEAS	WLCA2-LES	WLD28-LES
	Overtravel	General-purpose		WLH2-LEAS	WLH2-LES	—
		High-sensitivity		WLG2-LEAS	WLG2-LES	—
High-precision				—	WLGCA2-LES	—
LED operation indicator	Basic			WLCA2-LDAS	WLCA2-LDS	WLD28-LDS
	Overtravel	General-purpose		WLH2-LDAS	WLH2-LDS	—
		High-sensitivity		WLG2-LDAS	WLG2-LDS	—
High-precision				—	WLGCA2-LDS	—

Note: Ask your OMRON representative about WL01□□S Microload Switches.

**Long-life Switches**

Item			LED operation indicator *1			
			Basic	Overtravel		High-precision
Actuator			Model	Model	Model	Model
	Roller lever, screw terminal		WLMCA2-LD	WLMH2-LD	WLMG2-LD	WLMGCA2-LD
	2-conductor	AC	WLMCA2-LDK13A	WLMH2-LDK13A	WLMG2-LDK13A	WLMGCA2-LDK13A
		DC	WLMCA2-LDK13	WLMH2-LDK13	WLMG2-LDK13	WLMGCA2-LDK13
	4-conductor	AC	WLMCA2-LDK43A	WLMH2-LDK43A	WLMG2-LDK43A	WLMGCA2-LDK43A
		DC	WLMCA2-LDK43	WLMH2-LDK43	WLMG2-LDK43	WLMGCA2-LDK43
	2-conductor	DC	WLMCA2-LD-M1J	WLMH2-LD-M1J	WLMG2-LD-M1J	WLMGCA2-LD-M1J
	4-conductor	DC	WLMCA2-LD-DGJ03	WLMH2-LD-DGJ03	WLMG2-LD-DGJ03	—

\*1. The default setting is "light-ON when not operating."

Turn the lamp holder by 180° to change the setting to "light-ON when operating". (Ask your OMRON representative about 2-conductor models.)

\*2. With 0.3-m cable attached.

**Connecting Cables**



Straight Cable







Voltage specification	Number of conductors	Cable length	Model
AC	2	2 m	XS2F-A421-DB0-A
		5 m	XS2F-A421-GB0-A
	4	2 m	XS2F-A421-D90-A
		5 m	XS2F-A421-G90-A
DC	2	2 m	XS2F-D421-DD0-A
		5 m	XS2F-D421-GD0-A
	4	2 m	XS2F-D421-D80-A
		5 m	XS2F-D421-G80-A

## Individual Parts









### Heads

Actuator type	Set model	Head model (with Actuator)
<b>Roller lever</b> 	WLCA2	WL-1H1100
	WLG2	WL-2H1100
	WLH2	WL-2H1100-1 *
	WLCA2-2	WL-3H1100
	WLCA2-2N	WL-6H1100
<b>Adjustable roller lever</b> 	WLCA12	WL-1H2100
	WLG12	WL-2H2100
	WLH12	WL-2H2100-1 *
	WLCA12-2	WL-3H2100
<b>Adjustable rod lever</b> 	WLCL	WL-4H4100
	WGL	WL-2H4100
	WLCL-2	WL-3H4100
	WLCL-2N	WL-6H4100

Actuator type	Set model	Head model (with Actuator)
<b>Top plunger</b> 	WLD	WL-7H100
	WLD2	WL-7H200
	WLD3	WL-7H300
	WLD28	WL-7H400
<b>Horizontal plunger</b> 	WLS	WL-8H100
	WLS2	WL-8H200
	WLS3	WL-8H300
<b>Fork lever lock</b> 	WLCA32-41	WL-5H5100
	WLCA32-42	WL-5H5102
	WLCA32-43	WL-5H5104
	WLCA32-44	WL-5H5104
<b>Coil spring</b> 	WLNJ	WL-9H100
	WLNJ-30	WL-9H200
	WLNJ-2	WL-9H300
	WLNJ-S2	WL-9H400

\* The model number of Heads without levers are same as those of Heads with levers without the numbers at the end.  
 Example: WL-1H1100 becomes WL-1H without the lever.  
 However, the WLH2 and WLH12 become WL-2H-1 and the WLGCA2 becomes WL-1H-1 for the Heads without levers.  
 Other Heads are also available. Ask your OMRON representative.

### Switches without levers



Actuator type	Switches without levers 	
	Model	
<b>Switches for roller levers</b> 	Basic R38	WLRCA2
	High-precision R38	WLRGCA2
	High-sensitivity overtravel, 80°	WLRG2
	General-purpose overtravel, 80°	WLRH2
	Overtravel, 90° operation	WLRCA2-2
	Overtravel, 90° operation	WLRCA2-2N
<b>Switches for adjustable roller levers</b> 	Basic	WLRCA2
	High-sensitivity overtravel, 80°	WLRG2
	General-purpose overtravel, 80°	WLRH2
	Overtravel, 90° operation	WLRCA2-2
	Overtravel, 90° operation	WLRCA2-2N
<b>Switches for adjustable rod lever</b> 	Basic, 25 to 140 mm	WLRCL
	High-sensitivity overtravel, 80°, 25 to 140 mm	WLRG2
	Overtravel, 90° operation, 25 to 140 mm	WLRCA2-2
	Overtravel, 90° operation, 25 to 140 mm	WLRCA2-2N
Switches for top plungers 	—	—
Switches for horizontal plungers 	—	—
<b>Switches for fork lever locks</b> 	Maintained, WL-5A100 Maintained, WL-5A102 Maintained, WL-5A104	WLRCA32
Switches for coil springs 	—	—

### Covers with Operation Indicators



Cover	Cover only with indicator 	
	Model	
Item		
Neon lamp	WL-LE	
LED	WL-LD	

Note: The default setting is "light-ON when not operating."  
 Turn the lamp holder by 180° to change the setting to "light-ON when operating."



**Spatter-prevention Products  
Head (with actuator)**

Complete Heads with allen-head levers 	Double Nut Lever 
Model	Model
<b>WL-1H1100S</b> (for WLCA2-□ or WLGCA2-□)	<b>WL-2H1100S</b> (for WLH2-□ or WLG2-□)

**Lever**

Allen-head Lever 	Double Nut Lever 
Model	Model
<b>WL-1A103S</b> Roller lever	<b>WL-1A105S</b> Roller Lever

**Cover with indicator Switches without Levers**

Cover with Indicator 	Switches without levers 
Model	Model
Neon lamp <b>WL-LES</b>	<b>WLRCA2-LDS</b>
LED (LED) <b>WL-LDS</b>	<b>WLRH2-LES</b> <b>WLRH2-LDS</b>
	<b>WLRG2-LDS</b> <b>WLRGCA2-LES</b>

**WL Head Replacement**

Heads can be replaced within the same model group. They cannot be replaced between different model groups.

Group No.	Set model number	Head model number (with Actuator)
1	WLCA2	<b>WL-1H1100</b>
	WLCA2-7	<b>WL-1H1200</b>
	WLCA2-8	<b>WL-1H1300</b>
	WLCA12	<b>WL-1H2100</b>
2	WLCL	<b>WL-4H4100 *</b>
3	WLH2	<b>WL-2H1100-1</b>
	WLH12	<b>WL-2H2100-1</b>
	WLHL	<b>WL-2H4100</b>
	WLHAL4	<b>WL-2H4106</b>
	WLHAL5	<b>WL-2H4107</b>
4	WLCA2-2N	<b>WL-6H1100</b>
	WLCA12-2N	<b>WL-6H2100</b>
	WLCL-2N	<b>WL-6H4100</b>
5	WLCA2-2	<b>WL-3H1100</b>
	WLCA12-2	<b>WL-3H2100</b>
	WLCL-2	<b>WL-3H4100</b>
6	WLG2	<b>WL-2H1100</b>
	WLG12	<b>WL-2H2100</b>
	WGLL	<b>WL-2H4100</b>
7	WLCA32-41	<b>WL-5H5100</b>
	WLCA32-42	<b>WL-5H5102</b>
	WLCA32-43	<b>WL-5H5104</b>
	WLCA32-44	<b>WL-5H5104</b>
8	WLD	<b>WL-7H100</b>
	WLD2	<b>WL-7H200</b>
	WLD3	<b>WL-7H300</b>
9	WLD28	<b>WL-7H400 *</b>
10	WLSL	<b>WL-8H100</b>
	WLSL2	<b>WL-8H200</b>
	WLSL3	<b>WL-8H300</b>
11	WLNJ	<b>WL-9H100</b>
	WLNJ-30	<b>WL-9H200</b>
12	WLNJ-2	<b>WL-9H300 *</b>
13	WLNJ-S2	<b>WL-9H400 *</b>

\* This Heads are special and must be used. Do not use any other Head.

**Specifications**

**Approved Standards**

Agency	Standard	File No.	Approved models
UL	UL508	E76675	Contact your OMRON representative for information on approved models.
CSA	CSA C22.2 No.14	LR45746	
TÜV Rheinland	EN60947-5-1	J50022353, J9950023, J9950959	
CCC (CQC)	GB14048.5	2004010305128675	

## General-purpose/Weather-proof Switches

### Ratings

#### Standard-load Switches

Item Model	Rated voltage (V)	Non-inductive load (A)				Inductive load (A)			
		Resistive load		Lamp load		Inductive load		Motor load	
		NC	NO	NC	NO	NC	NO	NC	NO
Basic models, overtravel models (except for high-sensitivity models), and high-precision models	125 VAC	10	3	1.5	10	5	2.5		
	250 VAC	10	2	1	10	3	1.5		
	500 VAC	10	1.5	0.8	3	1.5	0.8		
	8 VDC	10	6	3	10	6			
	14 VDC	10	6	3	10	6			
High-sensitivity overtravel models	30 VDC	6	4	3	6	4			
	125 VDC	0.8	0.2	0.2	0.8	0.2			
	250 VDC	0.4	0.1	0.1	0.4	0.1			
	125 VAC	5	—	—	—	—			
	250 VAC	5	—	—	—	—			
High-sensitivity overtravel models	125 VDC	0.4	—	—	—	—			
	250 VDC	0.2	—	—	—	—			

Inrush current	NC	30 A max. (15 A max. *)
	NO	20 A max. (10 A max. *)

- Note: 1. The above figures are for steady-state currents.  
 2. Inductive loads have a power factor of 0.4 min. (AC) and a time constant of 7 ms max. (DC).  
 3. A lamp load has an inrush current of 10 times the steady-state current.  
 4. A motor load has an inrush current of 6 times the steady-state current.  
 5. For PC loads, use the microload models.

\* For high-sensitivity overtravel models.

Minimum applicable load	5 VDC 160 mA
-------------------------	--------------

#### Microload Switches (Refer to these ratings before using the product.)

Rated voltage (V)	Rated current (A) - Resistive load
AC 125	0.1
DC 30	

Operation in the following ranges will produce optimum performance.

Recommended load range	5 to 30 VDC 0.5 to 100 mA
------------------------	------------------------------

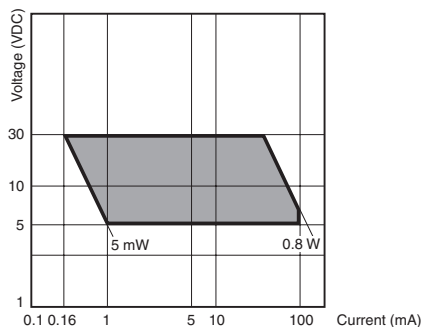

Recommended load range	5 VDC 1 mA
------------------------	------------

### Approved Standard Ratings

#### UL/CSA

#### Standard-load Switches: A600, NEMA

Rated voltage	Carry current	Current (A)		Volt-amperes (VA)	
		Make	Break	Make	Break
120 VAC	10 A	60	6	7,200	720
240 VAC		30	3		
480 VAC		15	1.5		
600 VAC		12	1.2		

#### Microload Switches

0.1 A 125 VAC, 0.1 A 30 VDC

TÜV (EN60947-5-1) (Only models with ground terminals are approved.)

Model	Application category and ratings	Thermal current (I <sub>the</sub> )	Indicator
WL□	AC-15: 2 A/250 V DC-12: 2 A/48 V	10 A	—
WL01□	AC-14: 0.1 A/125V DC-12: 0.1 A/48 V	0.5 A	—
WL□-LE	AC-15: 2 A/250 V	10 A	Neon lamp
WL01□-LE	AC-14: 0.1 A/125 V	0.5 A	Neon lamp
WL□-LD	AC-15: 2 A/115 V DC-12: 2 A/48 V	10 A	LED
WL01□-LD	AC-14: 0.1 A/115 V DC-12: 0.1 A/48 V	0.5 A	LED

Note: As an example, AC-15: 2 A/250 V means the following:

Application category	AC-15
Rated operating current (I <sub>e</sub> )	2A
Rated operating voltage (U <sub>e</sub> )	250V

### Indicator-equipped Switches

Model	Item	Max. rated voltage (V)	Leakage current (mA)
WL-LE	Neon lamp	125 AC	Approx. 0.6
		250 AC	Approx. 1.9
WL-LD	LED	115 AC/DC	Approx. 0.5
		10 to 24 AC/DC	Approx. 0.4

### Characteristics

Degree of protection	IP67	
Durability *1	Mechanical	15,000,000 operations min. *2
	Electrical	750,000 operations min. *3
Operating speed	1 mm/s to 1 m/s (in case of WLCA2)	
Operating frequency	Mechanical	120 operations/minute min.
	Electrical	30 operations/minute min.
Rated frequency	50/60 Hz	
Insulation resistance	100 MΩ min. (at 500 VDC)	
Contact resistance	25 mΩ max. (initial value for the built-in switch when tested alone) *6	
Dielectric strength	Between terminals of the same polarity	1,000 VAC (600 VAC), 50/60 Hz for 1 min
	Between current-carrying metal part and ground	2,200 VAC (1,500 VAC), 50/60 Hz for 1 min/Uimp 2.5 kV
	Between each terminal and non-current-carrying metal part	2,200 VAC (1,500 VAC), 50/60 Hz for 1 min/Uimp 2.5 kV
Rated insulation voltage (U <sub>i</sub> )	250 V (EN60947-5-1)	
Pollution degree (operating environment)	3 (EN60947-5-1)	
Short-circuit protective device (SCPD)	10 A, fuse type gG or gI (IEC60269)	
Conditional short-circuit current	100 A (EN60947-5-1)	
Conventional enclosed thermal current (I <sub>the</sub> )	10 A, 0.5 A (EN60947-5-1)	
Protection against electric shock	Class I	
Vibration resistance	Malfunction	10 to 55 Hz, 1.5-mm double amplitude *4
Shock resistance	Destruction	1,000 m/s <sup>2</sup> min.
	Malfunction	300 m/s <sup>2</sup> min. *4
Ambient operating temperature	-10°C to +80°C (with no icing) *5	
Ambient operating humidity	35% to 95% RH	
Weight	Approx. 275 g (in case of WLCA2)	

- Note: 1. The above figures are initial values.  
 2. The figures in parentheses for dielectric strength are those for the high-sensitivity overtravel models.

- \*1. The values are calculated at an operating temperature of +5°C to +35°C and an operating humidity of 40% to 70%RH. Contact your OMRON sales representative for more detailed information on other operating environments.  
 \*2. Durability is 10,000,000 operations min. for general-purpose or high-sensitivity overtravel models, and for flexible rod models. 500,000 operations min. for weather-proof models.  
 \*3. Durability is 500,000 operations min. for high-sensitivity models. All microload models are 1,000,000 operations min. 500,000 operations min. for weather-proof models.  
 \*4. Except flexible rod models. The shock resistance (malfunction) for microload models is 200 m/s<sup>2</sup> min.  
 \*5. For low-temperature models this is -40°C to +40°C (with no icing). For heat-resistant models the range is +5°C to +120°C.  
 \*6. For microload models, the contact resistance is 50 mΩ max. (initial value for built-in switch).

## Spatter-prevention Switches

### Ratings

#### Screw terminals

Item	Rated voltage (V)	Non-inductive load (A)				Inductive load (A)			
		Resistive load		Lamp load		Inductive load		Motor load	
		NC	NO	NC	NO	NC	NO	NC	NO
WL□-LES	125 VAC	10	3	1.5	10	5	2.5		
	250 VAC	10	2	1	10	3	1.5		
WL□-LDS	115 VAC	10	3	1.5	10	5	2.5		
	12 VDC	10	6	3	10	6			
	24 VDC	6	4	3	6	4			
	48 VDC	3	2	1.5	3	2			

Note: 1. The above figures are for steady-state currents.

2. Inductive loads have a power factor of 0.4 min. (AC) and a time constant of 7 ms max. (DC).

3. A lamp load has an inrush current of 10 times the steady-state current.

4. A motor load has an inrush current of 6 times the steady-state current.

Inrush current	NC	30 A max.
	NO	20 A max.
Operating temperature	-10°C to +80°C (with no icing)	
Operating humidity	35% to 95%RH max.	

### Approved Standard Ratings

#### UL/CSA

#### LE Switches (Neon lamp): A300

Rated voltage	Carry current	Current (A)		Volt-amperes (VA)	
		Make	Break	Make	Break
120 VAC	10 A	60	6	7,200	720
240 VAC		30	3		

#### LD Switches (LED)

Rated voltage	Carry current
115 VAC	10 A
115 VDC	0.8 A

#### CCC (GB14048.5)

Model	Application category and ratings
WL□	AC-15: 2 A/250 V DC-12: 2 A/48 V
WL01□	AC-14: 0.1 A/125V DC-12: 0.1 A/48 V
WL□-LE	AC-15: 2 A/250 V
WL01□-LE	AC-14: 0.1 A/125 V
WL□-LD	AC-15: 2 A/115 V DC-12: 2 A/48 V
WL01□-LD	AC-14: 0.1 A/115 V DC-12: 0.1 A/48 V

Note: As an example, AC-15: 2 A/250 V means the following:

Application category	AC-15
Rated operating current (Ie)	2 A
Rated operating voltage (Ue)	250 V

### Characteristics

Degree of protection	IP67	
Durability *1	Mechanical	15,000,000 operations min. *2
	Electrical	750,000 operations min. *3
Operating speed	1 mm/s to 1 m/s (in case of WLCA2)	
Operating frequency	Mechanical	120 operations/minute min.
	Electrical	30 operations/minute min.
Rated frequency	50/60 Hz	
Insulation resistance	100 MΩ min. (at 500 VDC)	
Contact resistance	25 mΩ max. (initial value for the built-in switch when tested alone)	
Dielectric strength	Between terminals of the same polarity	1,000 VAC (600 VAC), 50/60 Hz for 1 min
	Between current-carrying metal part and ground	2,200 VAC (1,500 VAC), 50/60 Hz for 1 min/Uimp 2.5 kV
	Between each terminal and non-current-carrying metal part	2,200 VAC (1,500 VAC), 50/60 Hz for 1 min/Uimp 2.5 kV
Rated insulation voltage (Ui)	250 V (EN60947-5-1)	
Pollution degree (operating environment)	3 (EN60947-5-1)	
Short-circuit protective device (SCPD)	10 A, fuse type gG or gI (IEC60269)	
Conditional short-circuit current	100 A (EN60947-5-1)	
Conventional enclosed thermal current (Ithe)	10 A, 0.5 A (EN60947-5-1)	
Protection against electric shock	Class I	
Vibration resistance	Malfuction	10 to 55 Hz, 1.5-mm double amplitude
Shock resistance	Destruction	1,000 m/s <sup>2</sup> min.
	Malfuction	300 m/s <sup>2</sup> min.
Ambient operating temperature	-10°C to +80°C (with no icing)	
Ambient operating humidity	35% to 95%RH	
Weight	Approx. 275 g (in case of WLCA2)	

Note: 1. The above figures are initial values.

2. The figures in parentheses for dielectric strength are those for the high-sensitivity overtravel models.

\*1. The values are calculated at an operating temperature of +5°C to +35°C and an operating humidity of 40% to 70%RH. Contact your OMRON sales representative for more detailed information on other operating environments.

\*2. Durability is 10,000,000 operations min. for general-purpose or high-sensitivity overtravel models.

\*3. Durability is 500,000 operations min. for high-precision models. All microload models however, are 1,000,000 operations min.

## Long-life Switches

### Ratings

General Ratings (Refer to these ratings before using the product.)

#### Screw Terminal Switches

Item Model	Rated voltage (V)	Non-inductive load (A)				Inductive load (A)			
		Resistive load		Lamp load		Inductive load		Motor load	
		NC	NO	NC	NO	NC	NO	NC	NO
Basic models, overtravel models, (except for high-sensitivity models), and high-precision models	115 AC	10	3	1.5	10	5	2.5		
	12 DC	10	6	3	10	6			
	24 DC	6	4	3	6	4			
	48 DC	3	2	1.5	3	2			
	115 DC	0.8	0.2	0.2	0.8	0.2			
High-sensitivity overtravel models	115 AC	5	—	—	—	—			
	115 DC	0.4	—	—	—	—			

Inrush current	NC	30 A max. (15 A max. *)
	NO	20 A max. (10 A max. *)

\* For high-sensitivity overtravel models.

#### Direct-wired Connector and Pre-wired Connector Switches

Model	Rated voltage (V)	Non-inductive load (A)				Inductive load (A)			
		Resistive load		Lamp load		Inductive load		Motor load	
		NC	NO	NC	NO	NC	NO	NC	NO
DC	12 DC	3	3	3	3	3	3	3	3
	24 DC	3	3	3	3	3	3	3	3
	48 DC	3	3	3	3	3	3	3	3
	115 DC	0.8	0.8	0.2	0.2	0.8	0.8	0.2	0.2
	AC	115 AC	3	3	3	1.5	3	3	3

- Note: 1. The above figures are for steady-state currents.  
 2. Inductive loads have a power factor of 0.4 min. (AC) and a time constant of 7 ms max. (DC).  
 3. A lamp load has an inrush current of 10 times the steady-state current.  
 4. A motor load has an inrush current of 6 times the steady-state current.

### Characteristics

Degree of protection		IP67
Durability *	Mechanical	30,000,000 operations min.
	Electrical	30,000,000 operations min. (10 mA at 24 VDC, resistive load) 750,000 operations min. (10 A at 115 VAC, resistive load), but for high-precision models: 500,000 operations min. (10 A at 115 VAC, resistive load)
Operating speed		1 mm/s to 1 m/s (in case of WLCA2)
Operating frequency	Mechanical	120 operations/minute
	Electrical	30 operations/minute
Rated frequency		50/60 Hz
Insulation resistance		100 MΩ min. (at 500 VDC)
Contact resistance		25 mΩ max. (initial value for the built-in switch when tested alone)
Dielectric strength (50/60 Hz for 1 min)	Between terminals of the same polarity	1,000 VAC (except connector models)
	Between current-carrying metal part and ground	2,200 VAC (1,500 V)
	Between each terminal and non-current-carrying metal part	2,200 VAC (1,500 V)
Vibration resistance	Malfunction	10 to 55 Hz, 1.5-mm double amplitude
Shock resistance	Destruction	1,000 m/s <sup>2</sup> min.
	Malfunction	300 m/s <sup>2</sup> min.
Ambient operating temperature		-10°C to +80°C (with no icing)
Ambient operating humidity		35% to 95%RH
Weight		Approx. 275 g (in case of WLCA2)

Note: The figures in parentheses for dielectric strength, are those for overtravel (high-sensitivity) or connector models.

\* The values are calculated at an operating temperature of +5°C to +35°C, and an operating humidity of 40% to 70%RH. Contact your OMRON sales representative for more detailed information on other operating environments.

### Engineering Data

#### Electrical Durability: $\cos\phi=1$

(Operating temperature: +5°C to +35°C, operating humidity: 40% to 70%RH)

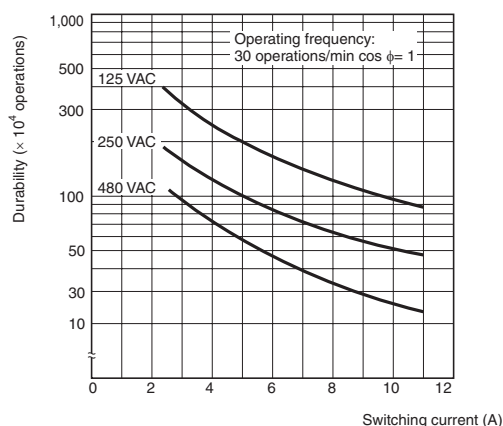

## Structure and Nomenclature

### Structure

#### General-purpose Switches: WLCA2

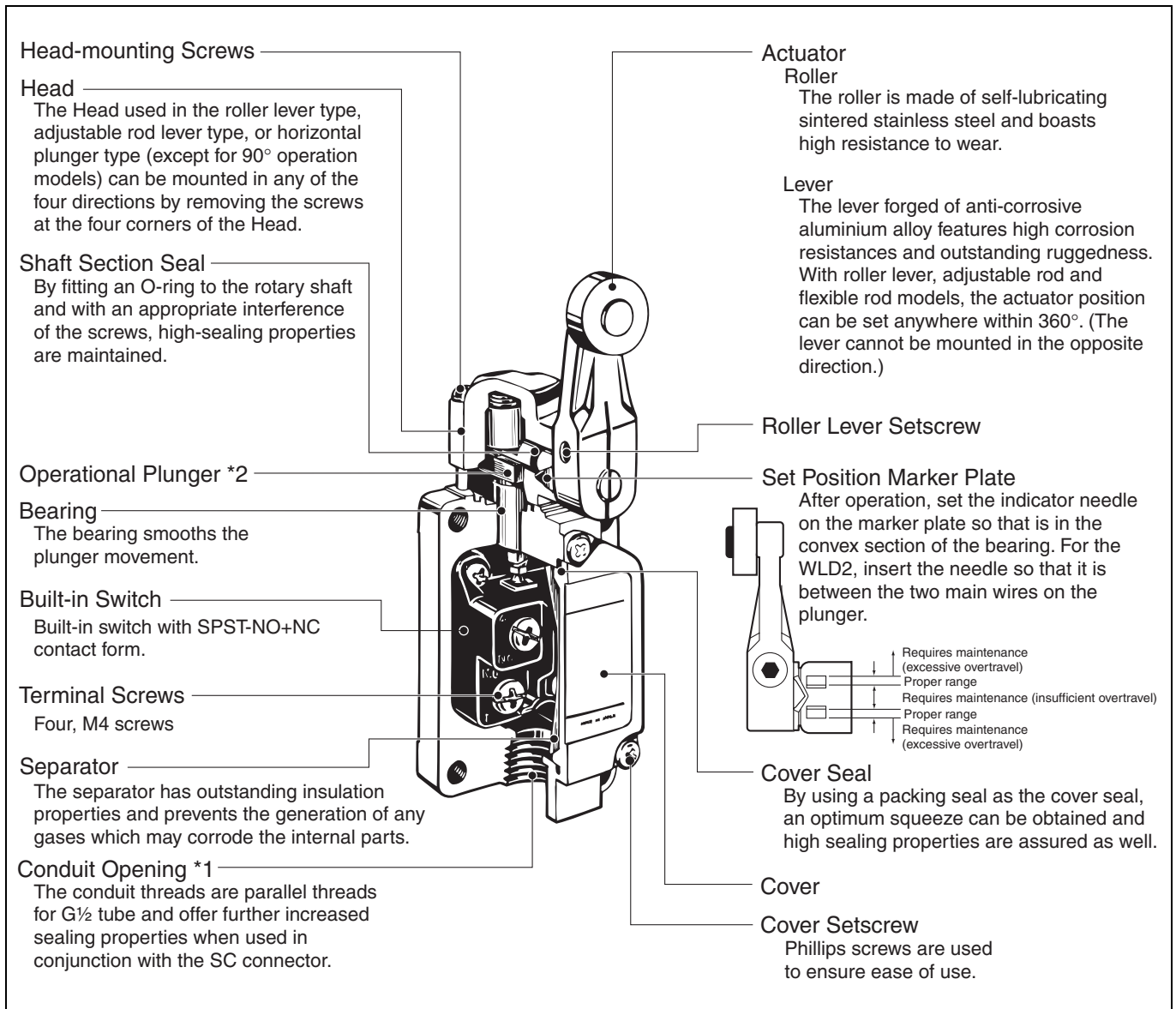

\*1. The display for conduit threads has changed from PF $\frac{1}{2}$  to G $\frac{1}{2}$ , according to revisions of JIS B 0202. This is only a change in the display, so the thread size and pitch have not changed. (Conduit threads Pg 13.5 and  $\frac{1}{2}$ -14NPT are also available.)

\*2. By changing the orientation of the operational plunger, any one of the three operational directions (both sides, left, or right) can be selected electrically.



Indicators

Indicator Covers

The indicator covered if outsert molded from diecast aluminum and has outstanding sealing properties.

Indicator Windows

Operation (i.e., light-ON when operating or light-ON when not operating) depends on whether a neon lamp or LED is used.

Light-ON when Operating/Not Operating

Indicators can be switched from light-ON when operating and light-ON when not operating, by simply rotating the indicator holder by 180°. (Molded terminals cannot be switched in this way.)

Light-ON when Operating

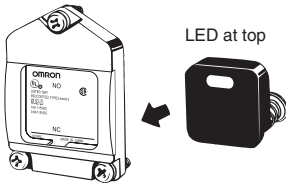

Light-ON when Not Operating

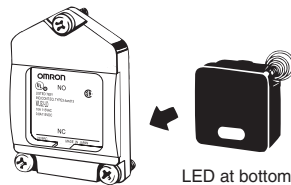

Indicator

The indicator is either a neon lamp or an LED. Models with LED indicators have a built-in rectifier stack, so it is not necessary to change the polarity.

Contact Spring

The built-in switch's terminal screws are used to connect the indicator terminal. Since the connection spring (coil spring) is used for this connection, it will not be necessary to connect the indicator terminal. When a ground terminal is provided however, a lead wire must be used.

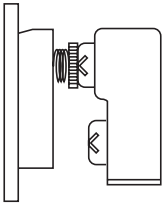

Operation

WL-LE WL-LD	Light-ON when operating *1	
	Light-ON when not operating *2	

Internal Circuits

WL-LE	
WL-LD	

Note: 1. The indicator cover cannot be replaced on the molded terminals. In all cases the indicator does not light when the load is ON.  
 2. Leakage current from indicator circuit may cause load's malfunction. Please check the load's OFF current before use the indicator-equipped switch.  
 \*1. Light-ON when operating means that the lamp lights when the Limit Switch contacts (NC) release, or when the actuator rotates or is pushed down.  
 \*2. Light-ON when not operating means the lamp remains lit when the actuator is free, or when the Limit Switch contacts (NO) close when the actuator rotates or is pushed down.

Environment-resistant Switches

Mold Specifications for Hermetic Seal Switches

■ : Molded parts

WL□-139

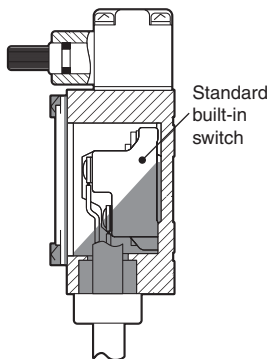

WL□-140

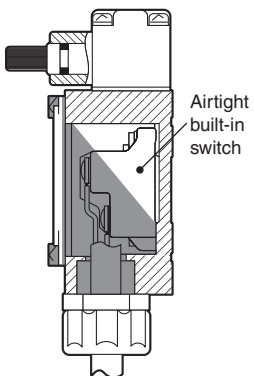

WL□-141

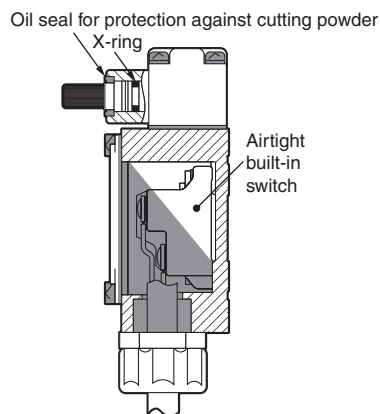

WL□-145

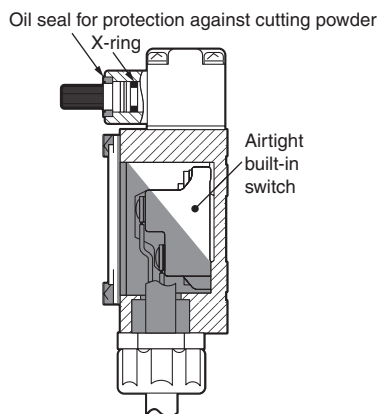

WL□-RP40

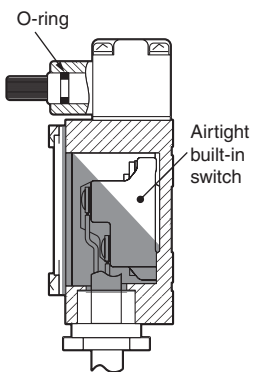

WL□-RP60

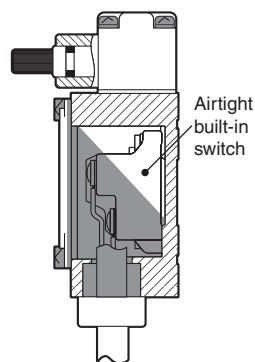

\* Florine rubber is used for all rubber parts.

Model	Cable specifications
WL□-139	Standard 5-m VCT (vinyl cabtire cable) cable attached. Finished diameter: 11.5 mm, 4-conductor.
WL□-140 WL□-141 WL□-145 WL□RP40 WL□RP60	Standard 5-m VCT cable, with high flexibility and good anti-oil properties attached. Finished diameter: 11.5 mm, 4-conductor.

Spatter-prevention Switches: WLCA2-LEAS

Actuator

Roller, Roller Axis  
Using stainless steel prevents spatter from adhering.

Operating Lever  
Melamine sinter-painted, it is easy to peel off the spatter.

Double Nut  
SUS is used for double nut.

Lamp Cover

· Heat-resistant resin is used for the lamp cover.  
· By using spherical surface for the display part, it disperses the direction of spatter.

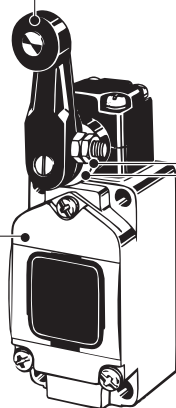

Screws

SUS is used, preventing spatter from adhering.

Head Cap

Using fluororesin prevents spatter from adhering.

\* Spatter means the zinc powder produced when welding.  
Adhering spatter to the Limit Switch may cause malfunction of lever or lamp cover.

The lack of gap prevents spatter powder from clogging.