



Chipsmall Limited consists of a professional team with an average of over 10 year of expertise in the distribution of electronic components. Based in Hongkong, we have already established firm and mutual-benefit business relationships with customers from,Europe,America and south Asia,supplying obsolete and hard-to-find components to meet their specific needs.

With the principle of “Quality Parts,Customers Priority,Honest Operation,and Considerate Service”,our business mainly focus on the distribution of electronic components. Line cards we deal with include Microchip,ALPS,ROHM,Xilinx,Pulse,ON,Everlight and Freescale. Main products comprise IC,Modules,Potentiometer,IC Socket,Relay,Connector.Our parts cover such applications as commercial,industrial, and automotives areas.

We are looking forward to setting up business relationship with you and hope to provide you with the best service and solution. Let us make a better world for our industry!



Contact us

Tel: +86-755-8981 8866 Fax: +86-755-8427 6832

Email & Skype: info@chipsmall.com Web: www.chipsmall.com

Address: A1208, Overseas Decoration Building, #122 Zhenhua RD., Futian, Shenzhen, China





WLG16P-24162120A00

W16

SMALL PHOTOELECTRIC SENSORS

SICK
Sensor Intelligence.



Illustration may differ



Ordering information

Type	Part no.
WLG16P-24162120A00	1218661

Other models and accessories → www.sick.com/W16

Detailed technical data

Features

Sensor/ detection principle	Photoelectric retro-reflective sensor, autocollimation
Dimensions (W x H x D)	20 mm x 55.7 mm x 42 mm
Housing design (light emission)	Rectangular
Sensing range max.	0 m ... 5 m ¹⁾
Type of light	Visible red light
Light source	PinPoint LED ²⁾
Light spot size (distance)	Ø 80 mm (5 m)
Wave length	635 nm
Adjustment	BluePilot: Teach-in plus user mode selector IO-Link
Pin 2 configuration	External input, Teach-in, switching signal
Special applications	Detecting transparent objects
Special features	Detecting transparent objects

¹⁾ Reflector P250F.

²⁾ Average service life: 100,000 h at T_J = +25 °C.

Mechanics/electronics

Supply voltage	10 V DC ... 30 V DC ¹⁾
Ripple	$\leq 5 V_{pp}$
Power consumption	30 mA ²⁾ 50 mA ³⁾
Switching output	PUSH/PULL PNP NPN
Output function	Factory setting: Pin 2 (MF): NPN normally closed (light switching), PNP normally open (dark switching), Pin 4 (QL1/C): NPN normally open (dark switching), PNP normally closed (light switching), IO-Link
Switching mode	Light/dark switching
Signal voltage PNP HIGH/LOW	Approx. $V_S - 2.5 V / 0 V$
Signal voltage NPN HIGH/LOW	Approx. $V_S / < 2.5 V$
Output current $I_{max.}$	$\leq 100 mA$
Response time	$\leq 500 \mu s$ ⁴⁾
Switching frequency	1,000 Hz ⁵⁾
Connection type	Male connector M12, 4-pin
Circuit protection	A ⁶⁾ B ⁷⁾ C ⁸⁾ D ⁹⁾
Protection class	III
Weight	50 g
Polarisation filter	✓
IO-Link	✓
Housing material	Plastic, VISTAL®
Optics material	Plastic, PMMA
Enclosure rating	IP66 IP67
Ambient operating temperature	-40 °C ... +60 °C
Ambient storage temperature	-40 °C ... +75 °C
UL File No.	NRKH.E181493 & NRKH7.E181493

¹⁾ Limit values.

²⁾ 16 V DC ... 30 V DC, without load.

³⁾ 10 V DC ... 16 V DC, without load.

⁴⁾ Signal transit time with resistive load in switching mode. Different values possible in COM2 mode.

⁵⁾ With light/dark ratio 1:1 in switching mode. Different values possible in IO-Link mode.

⁶⁾ A = V_S connections reverse-polarity protected.

⁷⁾ B = inputs and output reverse-polarity protected.

⁸⁾ C = interference suppression.

⁹⁾ D = outputs overcurrent and short-circuit protected.

Classifications

ECl@ss 5.0	27270904
ECl@ss 5.1.4	27270904
ECl@ss 6.0	27270904

ECl@ss 6.2	27270904
ECl@ss 7.0	27270904
ECl@ss 8.0	27270904
ECl@ss 8.1	27270904
ECl@ss 9.0	27270904
ETIM 5.0	EC002719
ETIM 6.0	EC002719
UNSPSC 16.0901	39121528

Smart Task

Smart Task name	Base logics
Logic function	Direct AND OR Window Hysteresis
Timer function	Deactivated On delay Off delay ON and OFF delay Impulse (one shot)
Inverter	Yes
Switching frequency	SIO Direct: 1000 Hz ¹⁾ SIO Logic: 800 Hz ²⁾ IOL: 650 Hz ³⁾
Response time	SIO Direct: 500 µs ¹⁾ SIO Logic: 600 µs ²⁾ IOL: 750 µs ³⁾
Repeatability	SIO Direct: 150 µs ¹⁾ SIO Logic: 300 µs ²⁾ IOL: 400 µs ³⁾
Switching signal Q_{L1}	Switching output
Switching signal Q_{L2}	Switching output

¹⁾ SIO Direct: sensor operation in standard I/O mode without IO-Link communication and without using internal sensor logic or time parameters (set to "direct"/"deactivated").

²⁾ SIO Logic: Sensor operation in standard I/O mode without IO-Link communication. Sensor-internal logic or timing parameters plus Automation Functions used.

³⁾ IOL: Sensor operation with full IO-Link communication and usage of logic, timing and Automation Function parameters.

Communication interface

Communication interface	IO-Link V1.1
Communication Interface detail	COM2 (38,4 kBaud)
Cycle time	2.3 ms
Process data length	16 Bit
Process data structure	Bit 0 = switching signal Q _{L1} Bit 1 = switching signal Q _{L2} Bit 2 ... 15 = empty
VendorID	26
DeviceID HEX	0x800170
DeviceID DEZ	8388976

Connection diagram

Cd-390

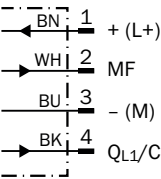

Light spot size

WLG16P-xxxxx1xx

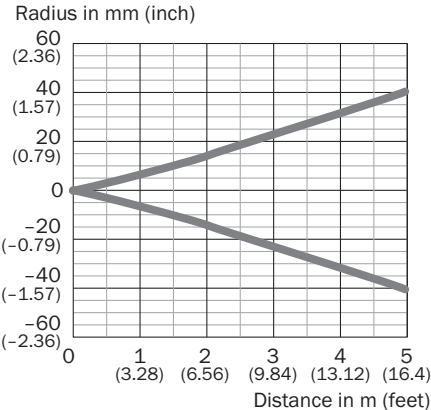

Sensing range diagram

WLG16P-xxxxx1xx

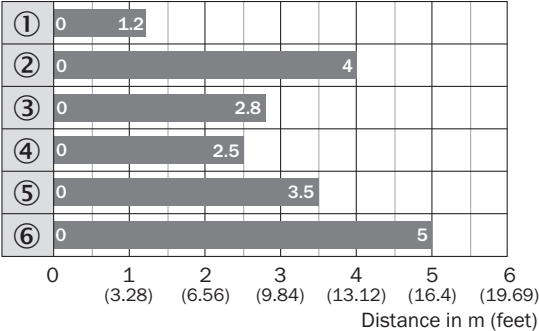

- Sensing range
- ① PL10F CHEM reflector
- ② Reflective tape REF-AC1000 (50 x 50 mm)
- ③ PL10FH-1 reflector
- ④ PL10F reflector
- ⑤ Reflector PL20F
- ⑥ Reflector P250F

Dimensional drawing (Dimensions in mm (inch))



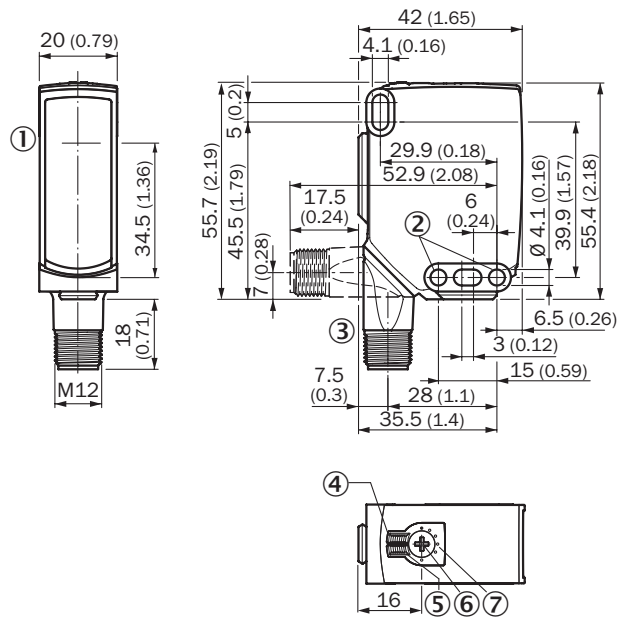

WLG16, connector



- ① Center of optical axis
- ② Mounting hole, \varnothing 4.1 mm
- ③ Connection
- ④ LED indicator green: power
- ⑤ LED indicator yellow: Status of received light beam
- ⑥ Teach-Turn adjustment of mode and sensitivity
- ⑦ BluePilot blue: Mode selection

Recommended accessories

Other models and accessories → www.sick.com/W16

	Brief description	Type	Part no.
Universal bar clamp systems			
	Plate N02 for universal clamp bracket, Zinc plated steel (sheet), Zinc die cast (clamping bracket), Universal clamp (5322626), mounting hardware	BEF-KHS-N02	2051608
	Bar clamp for bar diameter of 12 mm (fixing the mounting rod), Aluminum, 2 screws M6 x 30, 2 spring discs	BEF-RMC-D12	5321878
Device protection (mechanical)			
	Protective housing for universal clamp, Zinc plated steel (protective housing), Zinc die cast (clamping bracket), Universal clamp, mounting hardware	BEF-SG-W16	2096146
Mounting brackets and plates			
	Mounting bracket with articulated arm, steel, zinc coated, mounting hardware included	BEF-WN-MULTI2	2093945

	Brief description	Type	Part no.
Plug connectors and cables			
	Head A: female connector, M12, 4-pin, straight, A-coded Head B: Flying leads Cable: Sensor/actuator cable, PUR, halogen-free, unshielded, 2 m	YF2A14-020UB3XLEAX	2095607
	Head A: female connector, M12, 4-pin, straight, A-coded Head B: Flying leads Cable: Sensor/actuator cable, PVC, unshielded, 2 m	YF2A14-020VB3XLEAX	2096234
	Head A: female connector, M12, 4-pin, straight, A-coded Head B: Flying leads Cable: Sensor/actuator cable, PUR, halogen-free, unshielded, 5 m	YF2A14-050UB3XLEAX	2095608
	Head A: female connector, M12, 4-pin, straight, A-coded Head B: Flying leads Cable: Sensor/actuator cable, PVC, unshielded, 5 m	YF2A14-050VB3XLEAX	2096235
	Head A: female connector, M12, 4-pin, angled, A-coded Head B: Flying leads Cable: Sensor/actuator cable, PVC, unshielded, 2 m	YG2A14-020VB3XLEAX	2095895
	Head A: female connector, M12, 4-pin, angled, A-coded Head B: Flying leads Cable: Sensor/actuator cable, PVC, unshielded, 5 m	YG2A14-050VB3XLEAX	2095897
	Head A: female connector, M12, 4-pin, straight Head B: - Cable: unshielded	DOS-1204-G	6007302
		DOS-1204-GQU6	6042088
	Head A: female connector, M12, 4-pin, angled Head B: - Cable: unshielded	DOS-1204-W	6007303
	Head A: male connector, M12, 4-pin, straight Head B: - Cable: unshielded	STE-1204-G	6009932

SICK AT A GLANCE

SICK is one of the leading manufacturers of intelligent sensors and sensor solutions for industrial applications. A unique range of products and services creates the perfect basis for controlling processes securely and efficiently, protecting individuals from accidents and preventing damage to the environment.

We have extensive experience in a wide range of industries and understand their processes and requirements. With intelligent sensors, we can deliver exactly what our customers need. In application centers in Europe, Asia and North America, system solutions are tested and optimized in accordance with customer specifications. All this makes us a reliable supplier and development partner.

Comprehensive services complete our offering: SICK LifeTime Services provide support throughout the machine life cycle and ensure safety and productivity.

For us, that is “Sensor Intelligence.”

WORLDWIDE PRESENCE:

Contacts and other locations www.sick.com