



Chipsmall Limited consists of a professional team with an average of over 10 year of expertise in the distribution of electronic components. Based in Hongkong, we have already established firm and mutual-benefit business relationships with customers from,Europe,America and south Asia,supplying obsolete and hard-to-find components to meet their specific needs.

With the principle of “Quality Parts,Customers Priority,Honest Operation,and Considerate Service”,our business mainly focus on the distribution of electronic components. Line cards we deal with include Microchip,ALPS,ROHM,Xilinx,Pulse,ON,Everlight and Freescale. Main products comprise IC,Modules,Potentiometer,IC Socket,Relay,Connector.Our parts cover such applications as commercial,industrial, and automotives areas.

We are looking forward to setting up business relationship with you and hope to provide you with the best service and solution. Let us make a better world for our industry!



Contact us

Tel: +86-755-8981 8866 Fax: +86-755-8427 6832

Email & Skype: info@chipsmall.com Web: www.chipsmall.com

Address: A1208, Overseas Decoration Building, #122 Zhenhua RD., Futian, Shenzhen, China



Two-circuit Limit Switch/Long-life Two-circuit Limit Switch WL-N/WLM-N

Select the Best Two-circuit Switch for the Operating Environment and Application from a Wide Range of Models



- A wide selection of models is available, including general-purpose, environment-resistant, and spatter-prevention switches.
- Standard-feature gold-clad crossbar contacts provide high reliability.
- Applicable to either standard loads or microloads.
- Switches with lever actuators provide 90° overtravel, one-side operation, and four-direction head mounting.
- Approved standards: EN/IEC, UL, cUL, and CCC. Contact your OMRON representative for information on approved models.



! Be sure to read *Safety Precautions* on page 44 to 48 and *Safety Precautions for All Limit Switches*.

Features

Standard Switches

Many Variations in Standard Limit Switches A Wide Range of Models

The series includes many different actuators that you select to match the workpiece shape and motion, and a wide range of Switch variations, such as models with operation indicators for easier working and maintenance and models with different types of connectors.

Environment-resistant Switches

Select from Six Types of Environment Resistance

The series includes airtight switches, hermetic switches, heat-resistant switches, low-temperature switches, corrosion-proof switches, and weather-proof switches. You can select the model based on the onsite environment.

Spatter-prevention Switches

Excellent Performance on Arc Welding Lines or Sites with Spattering Cutting Powder Ideal for Welding Sites

These Switches use stainless steel or resin to prevent the adhesion of spatter. They can be used to reduce problems caused by zinc power generated during welding.

Long-life Switches

Mechanical Endurance of 30 Million Operations Long-life Models for High-frequency Applications

A mechanical durability of 30 million operations minimum is provided. The head features a double-seal structure with a head cap and oil seal.

Features Common to All Switches

DPDB Operation

The double-pole, double-break structure ensures circuit braking.

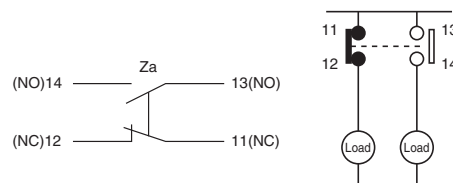

Degree of Protection; IP67

Approved Standards to Aid Export Machines

The Switches are certified for EN/IEC, UL, cUL, and CCC making them ideal for export machines.

Applicable to Either Standard Loads or Microloads

Standard-feature gold-clad contacts provide high reliability. The use of a high-contact-pressure crossbar structure also increases reliability.

Easy to Work With

Downsizing of the built-in switch has increased the space to house the wiring. The insulating paper that was often in the way when wiring has been eliminated. Nickel-plated steel screws are used for the terminal screws. The screws adhere to magnetized screwdrivers to prevent dropping and losing them.

Models with Connectors to Reduce Wiring

A neon lamp or LED indicates the operating status. The 3D structure of the lamp cover disperses light so you can check the operating status from the side.

WL-N/WLM-N

Product Configuration

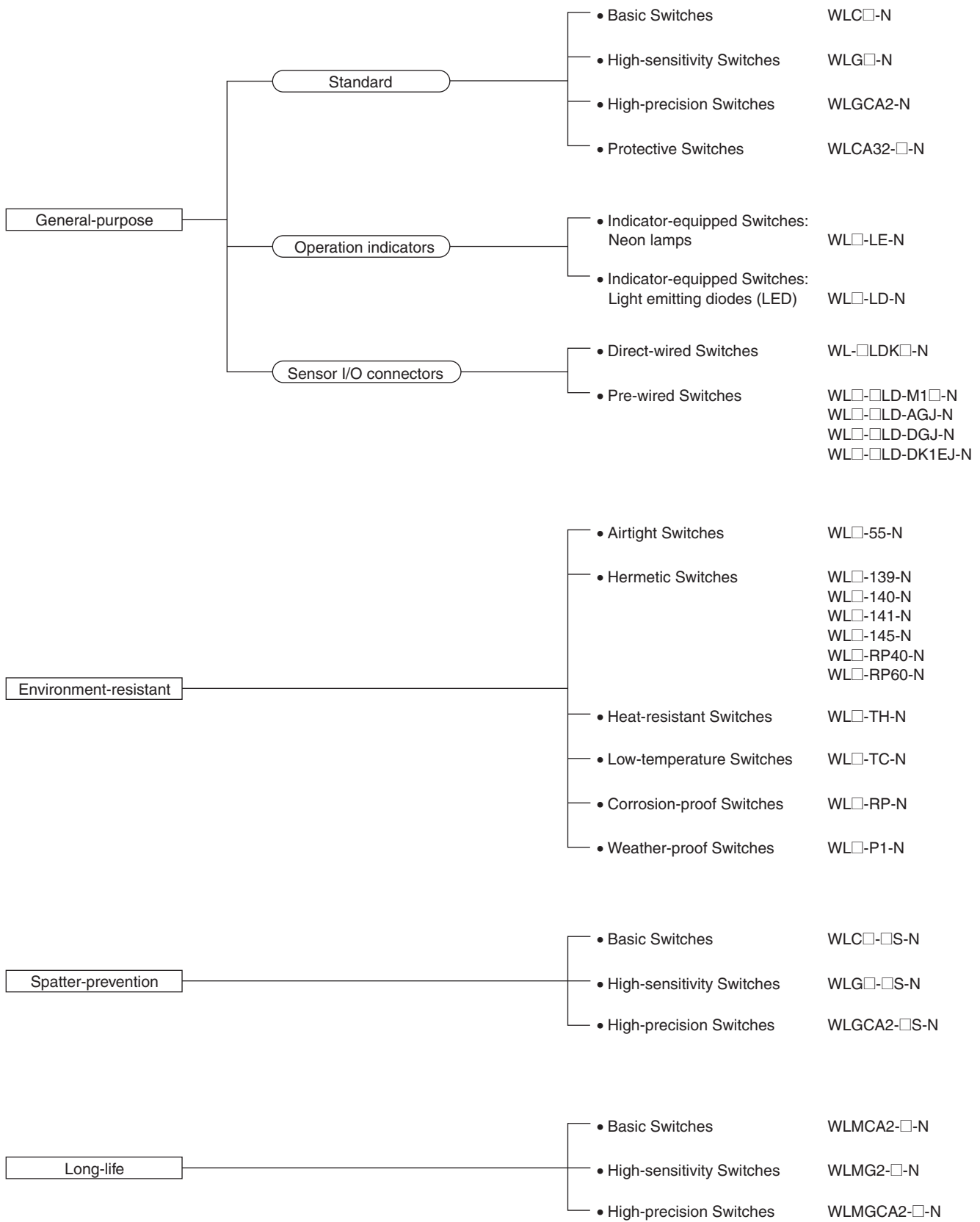

Environment-resistant Switches



Type	Item	Environment-resistant		
	Model	Application	Environment-resistant construction	Applicable models
Airtight seal	WL□-55-N	For use in locations subject to cutting oil or water.	Uses an airtight built-in switch. Note: Use the SC Connector for the conduit opening.	All models except the low-temperature and heat-resistant models Note: Models can be produced using standard actuators.
	WL□-139-N WL□-140-N WL□-141-N WL□-145-N WL□-RP40-N WL□-RP60-N		Refer to page 29 for information on the environment-resistant construction of Switches with Hermetic Seals.	All models except the low-temperature and heat-resistant models Note: Models can be produced using standard actuators. Only the WLCA2-N, WLGCA2-N, or WLG2-N can be produced for the WL□-141-N and WL□-145-N.
Low-temperature	WL□-TC-N	Can be used at a temperature of -40°C (operating temperature range: -40 to 40°C), but cannot withstand icing.	<ul style="list-style-type: none"> • Uses a general-purpose built-in switch. • Epichlorhydrin rubber is used for rubber parts such as the O-ring, gasket, etc. 	All models except airtight seal, hermetic seal, heat-resistant, corrosion-proof, and indicator-equipped models
Heat-resistant	WL□-TH-N	Can be used in temperatures of 120°C (operating temperature range: 5 to 120°C).	<ul style="list-style-type: none"> • Fluorine rubber is used for rubber parts such as the O-ring, gasket, etc. 	All models except airtight seal, hermetic seal, heat-resistant, corrosion-proof, and indicator-equipped, nylon roller (WLCA2-26N-N), seal roller models, and resin rod (WLNJ-2-N) models
Corrosion-proof	WL□-RP-N	For use in locations subject to corrosive gases and chemicals.	<ul style="list-style-type: none"> • Diecast parts, such as the switch box, are made of corrosion-proof aluminum. • Rubber sealing parts are made of fluorine rubber, which aids in resisting oils and chemicals. • Exposed nuts and screws (except the actuator section) are made of stainless steel. • Moving and rotary parts such as rollers are made of sintered stainless steel or stainless steel. • The head, box, and cover are yellow. 	All models except fork lever lock (WLCA32-41 to -44-N), low-temperature, heat-resistant, and indicator-equipped models
Weather-proof	WL□-P1-N	For use in parking lots and other outdoor locations.	<ul style="list-style-type: none"> • Rubber parts are made from epichlorhydrin rubber, which has a high-tolerance to changes in temperature. • Rollers are made of stainless steel to improve corrosion resistance. • Exposed nuts and screws are made of stainless steel. 	Only basic (WLCA2-N/CA12-N/CL-N), and high-sensitivity overtravel (WLG2-N/G12-N/GL-N) models (excluding heat-resistant models). This does not apply to low-temperature or heat-resistant, or indicator-equipped switches.

Selection Guide

With the WL-N Series, OMRON will combine the switch, actuator, and wiring method required to build the ideal switch for your application.

The WL-N Series consists of four basic types: general-purpose, environment-resistant, spatter-protection, and long-life switches. WLCA2-N Switches can be used for the most common applications.

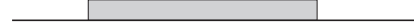
According to Operating Environment

Environment	Key specifications	Models	
Ambient operating temperature	<p>Normal</p> <p>–10°C +80°C</p>  <p>Water-resistant to IP67.</p>	<p>WL□-N General-purpose Switches</p> <p>WLM□-N Long-life Switches</p>	
	<p>High-temperature</p> <p>+5°C +120°C</p>  <p>To increase heat resistance, the rubber material (fluorine rubber) and the plunger material (PEEK) have been changed.</p>	<p>WL□-TH-N Heat-resistant Switches *1</p>	
	<p>Low-temperature</p> <p>–40°C +40°C</p>  <p>To increase resistance to cold, epichlorhydrin rubber and other measures are used.</p>	<p>WL□-TC-N Low-temperature Switches *1</p>	
Operating environment	<p>Outdoors</p> <p>Rubber parts are made from epichlorhydrin rubber, which has a high-tolerance to changes in temperature. Stainless steel is used for the screws. Rollers are made of stainless steel to provide superior corrosion resistance.</p>	<p>WL□-P1-N Weather-proof Switches *1</p>	
	<p>Chemicals and oil</p> <p>Corrosion-proof specifications have been used for the housing, fluorine rubber has been used for rubber parts, and stainless steel has been used for screws and nuts (except for the actuator) to increase resistance to oils, chemicals, and weather.</p>	<p>WL□-RP-N Corrosion-proof Switches *1</p>	
	<p>Water drops and mist</p> <p>Uses an airtight built-in switch.</p>	<p>WL□-55-N Airtight Switches *1</p>	
	<p>Constant water drops and mist</p>	<p>Cables are attached. Uses a general-purpose built-in switch. The cover screws, case cover, and conduit opening are molded from epoxy resin to increase the seal. (The cover cannot be removed.)</p>	<p>WL□-139-N Hermetic, Molded-terminal Switches *1, *2</p>
		<p>Cables are attached. Uses an airtight built-in switch. The case cover and conduit opening are molded from epoxy resin to increase the seal. (The cover cannot be removed.) The SC connector can be removed, so it is possible to use flexible conduit for the cable.</p>	<p>WL□-RP40-N Hermetic, Molded-terminal Switches *1, *2</p>
		<p>Cables are attached. Uses an airtight built-in switch. The cover screws, case cover, and conduit opening are molded from epoxy resin to increase the seal. (The cover cannot be removed.)</p>	<p>WL□-140-N Hermetic, Molded-terminal Switches *1, *2</p>
	<p>Constant water drops or splattering cutting powder</p> <p>Cables are attached. Uses an airtight built-in switch. The cover screws, case cover, and conduit opening are molded from epoxy resin to increase the seal. (The cover cannot be removed.) Double seal against oil including head cap countermeasure for cutting chips and an oil seal.</p> <p>-141: The Head section is molded from epoxy resin; Head direction cannot be changed.</p> <p>-145: The Head section is molded from epoxy resin; Head can be in any of 4 directions.</p>	<p>WL□-141-N, -145-N Hermetic, Molded-terminal Switches *1, *2 (Only the WLCA2-N, WLG2-N, and WLGCA2-N, can be produced.)</p>	
<p>Coolant</p> <p>Cables are attached. Uses an airtight built-in switch. The cover screws, case cover, conduit opening, and head screws are molded from epoxy resin to increase the seal. (The cover and head cannot be removed.) Rubber parts are made from fluorine rubber to increase resistance to coolant.</p>	<p>WL□-RP60-N Hermetic, Molded-terminal Switches *1, *2</p>		
<p>Spattering from welding</p> <p>To prevent spatter during welding, a heat-resistant resin is used for the indicator cover and screws and rollers are all made from stainless steel.</p>	<p>WL□-S-N Spatter-prevention Switches</p>		

*1. Not all functions can be combined with environment-resistant switches. Refer to the applicable models on the previous page.

*2. Refer to page 29 for information on the construction of Hermetic Switches.











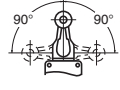



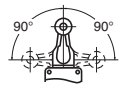
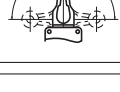

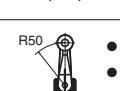

According to Application Conditions

	Conditions	Key specifications	Models
Load	Switching standard loads	10 A at 125, 250, or 500 VAC 0.8 A at 125 VDC 0.4 A at 250 VDC	Entire WL□-□-N Series Applicable to either standard loads or microloads.
	Switching microloads	0.1 A at 125 VAC, resistive load 0.1 A at 30 VDC, resistive load	
Durability	Normal durability	Mechanical: 15 million operation min. (10 million operation min. for high-sensitivity models or flexible rod models)	WL□-N General-purpose Switches WL□-S-N Spatter-prevention Switches
	Long-life	Mechanical: 30 million operation min.	WLM□-N Long-life Switches

According to Ease of Installation and Maintenance

	Conditions	Key specifications	Models
Operation indicator	Daily inspections and maintenance checks	Neon lamp 125 to 250 VAC Switching light-ON between operating/not operating. (Switching is not possible for Switches with Molded Terminals.)	WL□-LE-N General-purpose, Indicator-equipped (Neon Lamp) Switches WL□-LES-N Spatter-prevention, Indicator-equipped (Neon Lamp) Switches
		LED 10 to 115 VAC/DC Switching light-ON between operating/not operating. (Switching not possible for models with molded terminals.)	WL□-LD-N General-purpose, Indicator-equipped (LED) Switches WL□-LDS-N Spatter-prevention, Indicator-equipped (LED) Switches
Wiring specification	Screw tightening and installation	Screw terminals. No ground terminal. Conduit size: G1/2	WL□-N General-purpose Switches WLM□-N Long-life Switches
		Screw terminals. Ground terminal. Conduit size: 4 sizes	WL□-N General-purpose Switches
	One-touch connector attachment	Direct-wired connector, 2-conductor. Greatly reduces wiring work.	WL□-□LDK13□-N General-purpose, Direct-wired Connector Switches WLM□-LDK13□-N Long-life, Direct-wired Connector Switches
		Direct-wired connector, 4-conductor. Greatly reduces wiring work.	WL□-□LDK43□-N General-purpose, Direct-wired Connector Switches WLM□-LDK43□-N Long-life, Direct-wired Connector Switches
	Connector attachment in control and relay boxes	Pre-wired connector, 2-conductor. Greatly reduces wiring work. Smartclick connectors for even easier maintenance.	WL□-□LD-M1□J-N General-purpose, Pre-wired Connector Switches WL□-□S-M1□J-1-N Spatter-prevention, Pre-wired Connector Switches WLM□-LD-M1□J-N Long-life, Pre-wired Connector Switches
		Pre-wired connector, 4-conductor. Greatly reduces wiring work. Smartclick connectors for even easier maintenance.	WL□-□LD-□GJ-N General-purpose, Pre-wired Connector Switches WL□-□S-□GJS-N Spatter-prevention, Pre-wired Connector Switches WLM□-LD-□GJ-N Long-life, Pre-wired Connector Switches

According to Form of Operation

	Detection object	Key specifications	Models	
Operation angles	General	TT (total travel)  PT (pretravel)   	WLCA2-N WLCA2-2-N WLCA2-2N-N WLCA2-□S-N WLMCA2-N	General-purpose Switches General-purpose Switches General-purpose Switches Spatter-prevention Switches Long-life Switches
	Passing dogs		WLCA2-N WLCA2-2-N WLCA2-2N-N	General-purpose Switches General-purpose Switches General-purpose Switches Spatter-prevention Switches Long-life Switches
	Passing dogs, high sensitivity	 	WLG2-N WLG2-□S-N WLMG2-N	General-purpose Switches Spatter-prevention Switches Long-life Switches
	High precision	 	WLCA2-N WLCA2-2-N WLCA2-2N-N WLCA2-□S-N WLMCA2-N	General-purpose Switches Spatter-prevention Switches Long-life Switches
Actuators	Dogs and workpieces (Mounts in any of 4 directions)	 <ul style="list-style-type: none"> ● Short lever ● One-Horizontal operation possible. ● Head mounts in any of 4 directions. 	WL□2-N WL□2-□S-N WLM□2-N	Roller Lever Actuators Roller Lever Actuators Roller Lever Actuators
		 <ul style="list-style-type: none"> ● Medium lever ● One-side operation possible. ● Head mounts in any of 4 directions. 	WL□2-7-N	Roller Lever Actuators
		 <ul style="list-style-type: none"> ● Long lever ● One-side operation possible. ● Head mounts in any of 4 directions. 	WL□2-8-N	Roller Lever Actuators
	Adjustable between dog and lever	 <ul style="list-style-type: none"> ● One-Horizontal operation possible. ● Head mounts in any of 4 directions. 	WL□12-N	Adjustable Roller Lever Actuators
	Dogs or workpieces with large deflection	 <ul style="list-style-type: none"> ● One-Horizontal operation possible. ● Head mounts in any of 4 directions. 	WLCL-N	Adjustable Rod Lever Actuators
		 <ul style="list-style-type: none"> ● One-side operation possible. ● Head mounts in any of 4 directions. 	WLCAL4-N	Adjustable Rod Lever Actuator
		 <ul style="list-style-type: none"> ● One-side operation possible. ● Head mounts in any of 4 directions. 	WLCAL5-N	Rod Spring Lever Actuator
	Round-trip operation of passing dogs	 <ul style="list-style-type: none"> ● Head mounts in any of 4 directions. 	WLCA32-41-N	Fork Lever Lock Actuator
		 <ul style="list-style-type: none"> ● Head mounts in any of 4 directions. 	WLCA32-42-N	Fork Lever Lock Actuator
		 <ul style="list-style-type: none"> ● Head mounts in any of 4 directions. 	WLCA32-43-N	Fork Lever Lock Actuator
		 <ul style="list-style-type: none"> ● Head mounts in any of 4 directions. 	WLCA32-44-N	Fork Lever Lock Actuator
	Cams or workpieces with vertical movement	<ul style="list-style-type: none"> ● Equipped with sealing boot. 	WLD18-N	Sealed Top Plunger Actuator
<ul style="list-style-type: none"> ● Head mounts in any of 4 directions. 		WLSD-N	Horizontal Plunger Actuator	
<ul style="list-style-type: none"> ● Equipped with sealing boot. 		WLD38-N	Sealed Top-ball Plunger Actuator	
<ul style="list-style-type: none"> ● Head mounts in any of 4 directions. 		WLSD3-N	Horizontal-ball Plunger Actuator	
<ul style="list-style-type: none"> ● Equipped with sealing boot. 		WLD28-N	Sealed Top-roller Plunger Actuator	
<ul style="list-style-type: none"> ● Head mounts in any of 4 directions. 	WLSD2-N	Horizontal-roller Plunger Actuator		

Application Examples

Detection of Passing Pallets on Production Lines

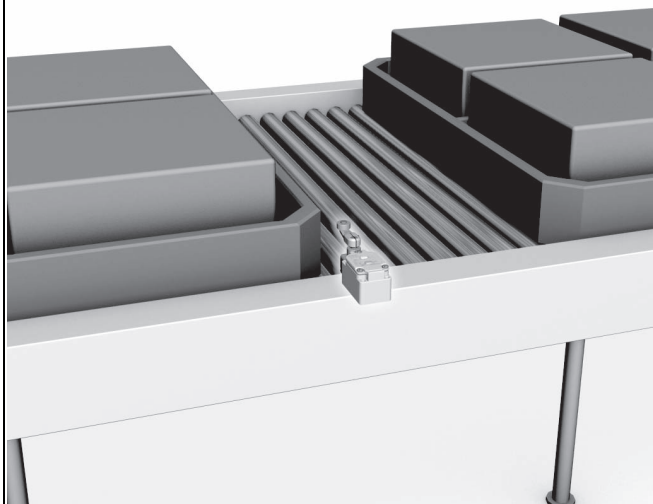

Detection of Work Table Origins (X, Y, and Z) on Machine Tools



Detection of Forward and Reverse Movement of Hydraulic Cylinders on Molding Machines



Detection of Arm Movement on Welding Robots

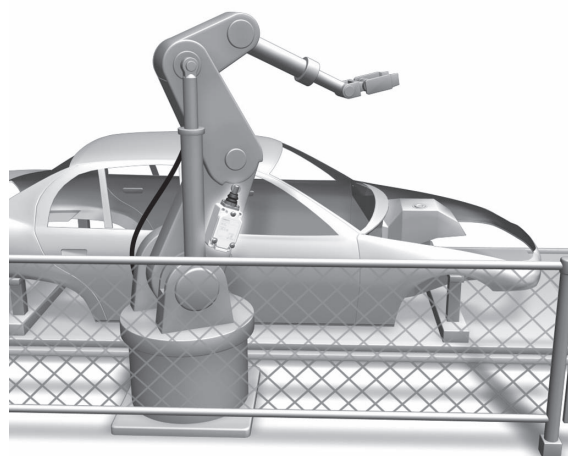

Detection of Car Pallet Positions in Parking Towers

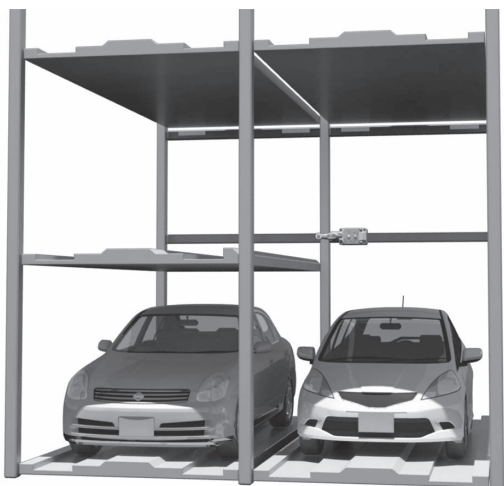

Detection of Vertical Limits on Conveyor Systems

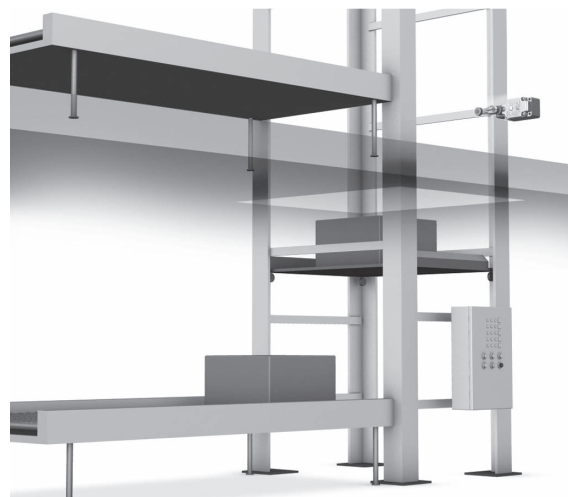

WL-N/WLM-N

Model Number Structure

Model Number Legend (Not all combinations are possible. Contact your OMRON representative for details.)

General-purpose Switches

WL□ - □□□□ -N
 (1) (2) (3) (4) (5)

(1) Actuator and Property Specifications

Code	Lever	Pretravel (PT)
CA2	Roller lever: R38 mm	15±5°
CA2-7	Roller lever: R50 mm	
CA2-8	Roller lever: R63 mm	
CA12	Adjustable roller lever: R25 to 89 mm	
CL	Adjustable rod lever: 25 to 140 mm	
CAL4	Adjustable rod lever: 350 to 380 mm	
CAL5	Rod spring lever	
CA2-2	Roller lever: R38 mm	25±5°
CA12-2	Adjustable roller lever: R25 to 89 mm	
CL-2	Adjustable rod lever: 25 to 140 mm	
CA2-2N	Roller lever: R38 mm	MAX 20°
CA12-2N	Adjustable roller lever: R25 to 89 mm	
CL-2N	Adjustable rod lever: 25 to 140 mm	
G2	Roller lever, high sensitivity: R38 mm	10° ^{+2°} _{-1°}
G12	Adjustable roller lever, high sensitivity: R25 to 89 mm	
GL	Adjustable rod lever, high sensitivity: 25 to 140 mm	
GCA2	Roller lever, high precision: R38 mm	5° ^{+2°} _{0°}
CA32-41	Fork lever lock	50±5°
CA32-42	Fork lever lock	
CA32-43	Fork lever lock	
D18	Sealed top plunger	1.7 mm
D28	Sealed top-roller plunger	
D38	Sealed top-ball plunger	
SD	Horizontal plunger	2.8 mm
SD2	Horizontal-roller plunger	
SD3	Horizontal-ball plunger	
NJ	Flexible rod: Coil spring	20±10 mm
NJ-30	Flexible rod: Coil spring, multi-wire	
NJ-2	Flexible rod: Resin rod	
NJ-S2	Flexible rod: Steel wire	40±20 mm

(2) Built-in Switch Type

Code	Specification
Blank	Standard built-in switch
55	Airtight built-in switch

(3) Conduit Size, Ground Terminal Specifications

Code	Specifications	
	Conduit Size	Ground terminal
Blank	G1/2	None
G1	G1/2	Provided *
G	Pg13.5	
Y	M20	
TS	1/2-14NPT	

* Models with ground terminals are certified for EN/IEC (CE Marking).

(4) Indicator Type

Code	Specifications
Blank	No indicator
LE	Neon lamp: 125 to 250 VAC
LD	LED (10 to 115 VAC/DC)

(5) Lever Type

Code	Specifications
Blank	Standard lever (Allen-head bolt)
A	Double nut lever

Model Number Legend (Not all combinations are possible. Contact your OMRON representative for details.)

General-purpose Switches

Sensor I/O Connector Switches

WL₍₁₎ - **LD**₍₂₎ **LD**₍₃₎ - **N**₍₄₎

(1) Actuator and Property Specifications

Code	Lever	Pretravel (PT)
CA2	Roller lever: R38 mm	15±5°
G2	Roller lever, high sensitivity: R38 mm	10° ^{+2°} _{-1°}
GCA2	Roller lever, high precision: R38 mm	5° ^{+2°} _{0°}
D28	Sealed top-roller plunger	1.7 mm

(2) Built-in Switch Type

Code	Specification
Blank	Standard built-in switch
55	Airtight built-in switch

(3) Indicator Type

Code	Specifications
LD	LED (10 to 115 VAC/DC)

(4) Connector Type

Code	Specification					
	Shape	Voltage used *1	Wiring locations	Connector pin No. *2		
K13A	Direct-wired connector	Threaded (M12)	AC	NO only	NO: ③ ④	
K13			DC	NO only	NO: ③ ④	
K43A			AC	NC+NO	NC: ① ②, NO: ③ ④	
K43			DC	NC+NO	NC: ① ②, NO: ③ ④	
-M1J	Pre-wired connector *3	Threaded (M12)	DC	NO only	NO: ③ ④	
-M1GJ			DC	NO only	NO: ① ④	
-M1JB			DC	NC only	NC: ② ③	
-AGJ			AC	NC+NO	NC: ① ②, NO: ③ ④	
-DGJ			DC	NC+NO	NC: ① ②, NO: ③ ④	
-DK1EJ			DC	NO only	NC: ②, NO: ③ ④	
-M1TJ			Smartclick	DC	NO only	NO: ③ ④
-M1TGJ				DC	NO only	NO: ① ④
-M1TJB				DC	NC only	NC: ② ③
-DTGJ				DC	NC+NO	NC: ① ②, NO: ③ ④
-DTK1EJ	DC	NO only		NC: ②, NO: ③ ④		

*1. DC models are certified for EN/IEC (CE Marking).

*2. Refer to *Contact Forms* on page 16 for details on connector pin numbers.

*3. The standard cable length is 0.3 m. Contact your OMRON representative for information on other cable lengths.

Model Number Legend (Not all combinations are possible. Contact your OMRON representative for details.)

Environment-resistant Switches

WL□ - □□□□□□□□ -N
 (1) (2) (3) (4) (5) (6) (7) (8) (9)

(1) Actuator and Property Specifications

Code	Lever	Pretravel (PT)
CA2	Roller lever: R38 mm	15±5°
CA2-7	Roller lever: R50 mm	
CA2-8	Roller lever: R63 mm	
CA12	Adjustable roller lever: R25 to 89 mm	
CL	Adjustable rod lever: 25 to 140 mm	
CAL4	Adjustable rod lever: 350 to 380 mm	
CAL5	Rod spring lever	25±5°
CA2-2	Roller lever: R38 mm	
CA12-2	Adjustable roller lever: R25 to 89 mm	
CL-2	Adjustable rod lever: 25 to 140 mm	MAX 20°
CA2-2N	Roller lever: R38 mm	
CA12-2N	Adjustable roller lever: R25 to 89 mm	10° ^{+2°} _{-1°}
CL-2N	Adjustable rod lever: 25 to 140 mm	
G2	Roller lever, high sensitivity: R38 mm	5° ^{+2°} _{0°}
G12	Adjustable roller lever, high sensitivity: R25 to 89 mm	
GL	Adjustable rod lever, high sensitivity: 25 to 140 mm	55°
GCA2	Roller lever, high precision: R38 mm	
CA32-41	Fork lever lock	
CA32-42	Fork lever lock	1.7 mm
CA32-43	Fork lever lock	
D18	Sealed top plunger	
D28	Sealed top-roller plunger	2.8 mm
D38	Sealed top-ball plunger	
SD	Horizontal plunger	20±10 mm
SD2	Horizontal-roller plunger	
SD3	Horizontal-ball plunger	
NJ	Flexible rod: Coil spring	40±20 mm
NJ-30	Flexible rod: Coil spring, multi-wire	
NJ-2	Flexible rod: Resin rod	40±20 mm
NJ-S2	Flexible rod: Steel wire	

(2) Environment-resistant Model Specifications

Code	Specifications
Blank	Standard
RP	Corrosion-proof
P1	Weather-proof

(3) Built-in Switch Type

Code	Specifications
Blank	Standard built-in switch
55	Airtight built-in switch

(4) Temperature Specifications

Code	Specifications
Blank	Standard: -10°C to +80°C
TH	Heat-resistant: +5°C to +120°C *1
TC	Low-temperature: -40°C to +40°C *1

*1. Cannot be combined with Corrosion-proof (RP) or Weather-proof (P1) Switches.

(5) Hermetic Specification

Code	Specifications
Blank	No cable molding.
139	Standard built-in switch. Cable is attached. Molded conduit opening and cover. (The cover cannot be removed.)
140	Airtight built-in switch. Cable is attached. Molded conduit opening, cover, and cover screws. (The cover cannot be removed.)
141	Airtight built-in switch. Cable is attached. Molded conduit opening, cover, head, cover screws, and head screws. (The cover cannot be removed and the head direction cannot be changed.) Double seal against oil including head cap countermeasure for cutting chips and an oil seal.
145	Airtight built-in switch. Cable is attached. Molded conduit opening, cover, and cover screws. (The cover cannot be removed. The head can be mounted in any of 4 directions.) Double seal against oil including head cap countermeasure for cutting chips and an oil seal.
RP40	Airtight built-in switch. Cable is attached. Molded conduit opening and cover. (The cover cannot be removed.) SC Connector can be removed, so it is possible to use flexible conduits for the cable.
RP60	Airtight built-in switch. Cables are attached. Molded conduit opening, cover, cover screws, and head screws. (The cover cannot be removed and the head direction cannot be changed.) Fluorine rubber is used for all rubber parts.

(6) Conduit Size, Ground Terminal Specifications

Code	Specifications	
	Conduit Size	Ground terminal
Blank	G1/2	None
G1	G1/2	Provided *2
G	Pg13.5	
Y	M20	
TS	1/2-14NPT	

*2. Models with ground terminals are certified for EN/IEC (CE Marking).

(7) Indicator Type

Code	Specifications
Blank	No indicator
LE	Neon lamp: 125 to 250 VAC
LD	LED (10 to 115 VAC/DC)

*3. Cannot be combined with Corrosion-proof (RP), Weather-proof (P1), Heat-resistant (TC), or Low-temperature (TC) Switches.

(8) Indicator Wiring Specification

Code	Specifications
2	NC connection: Light-ON when operating
3	NO connection: Light-ON when not operating

*4. Always include the indicator wiring specification if you specify a (5) hermetic structure and an (7) indicator.

(9) Lever Type

Code	Specifications
Blank	Standard lever (Allen-head bolt)
A	Double nut lever

Model Number Legend (Not all combinations are possible. Contact your OMRON representative for details.)

Spatter-prevention Switches

WL□ - □□□ S□ -N
 (1) (2) (3) (4)

(1) Actuator and Property Specifications

Code	Lever	Pretravel (PT)
CA2	Roller lever: R38 mm	15±5°
G2	Roller lever, high sensitivity: R38 mm	10° ^{+2°} _{-1°}
GCA2	Roller lever, high precision: R38 mm	5° ^{+2°} _{0°}
D28	Sealed top-roller plunger	1.7 mm

(2) Built-in Switch Type

Code	Specifications
Blank	Standard built-in switch
55	Airtight built-in switch

(3) Indicator Type

Code	Specifications
LE	Neon lamp: 125 to 250 VAC *1
LD	LED (10 to 115 VAC/DC)

*1. Cannot be combined with a Switch with a Connector.

(4) Connector Type

Code	Specifications				
	Shape	Voltage *2	Wiring locations	Connector pin No. *3	
Blank	No connector	—	—	—	
-M1J-1	Pre-wired Connector *4	Threaded (M12)	DC	NO only	NO: ③ ④
-M1GJ-1			DC	NO only	NO: ① ④
-DGJS		DC	NC+NO	NC: ① ②, NO: ③ ④	
-DTGJS		Smartclick	DC	NC+NO	NC: ① ②, NO: ③ ④

*2. DC models are certified for EN/IEC (CE Marking).

*3. Refer to *Contact Forms* on page 16 for details on connector pin numbers.

*4. The standard cable length is 0.3 m. Contact your OMRON representative for information on other cable lengths.

Model Number Legend (Not all combinations are possible. Contact your OMRON representative for details.)

Long-life Switches

WLM□ - LD□ -N
(1) (2) (3)

(1) Actuator and Property Specifications

Code	Lever	Pretravel (PT)
CA2	Roller lever: R38 mm	15±5°
G2	Roller lever, high sensitivity: R38 mm	10° ^{+2°} _{-1°}
GCA2	Roller lever, high precision: R38 mm	5° ^{+2°} _{0°}

(2) Indicator Type

Code	Specifications
LD	LED (10 to 115 VAC/DC)

(3) Connector Type

Code	Specifications				
	Shape		Voltage	Wiring locations	Connector pin No.
Blank	Screw terminals: G1/2 conduit	—	—	—	—
K13A	Direct-wired connector	Threaded (M12)	AC	NO only	NO: ③ ④
K13			DC	NO only	NO: ③ ④
K43A			AC	NC+NO	NC: ① ②, NO: ③ ④
K43			DC	NC+NO	NC: ① ②, NO: ③ ④
-M1J	Pre-wired connector *1	Threaded (M12)	DC	NO only	NO: ③ ④
-AGJ			AC	NC+NO	NC: ① ②, NO: ③ ④
-DGJ			DC	NC+NO	NC: ① ②, NO: ③ ④
-M1TJ		Smartclick	DC	NO only	NO: ③ ④
-ATGJ			AC	NC+NO	NC: ① ②, NO: ③ ④
-DTGJ			DC	NC+NO	NC: ① ②, NO: ③ ④

*1. The standard cable length is 0.3 m. Contact your OMRON representative for information on other cable lengths.





Ordering Information





General-purpose Switches

Standard Switches



Switches with Lever Actuators



Actuator		Roller lever R38 	Roller lever: R50 	Roller lever: R63 
Item	Pretravel (PT)	Model	Model	Model
Basic	15±5°	WLCA2-N	WLCA2-7-N	WLCA2-8-N
	25±5°	WLCA2-2-N	—	—
	MAX20°	WLCA2-2N-N	—	—
High-sensitivity	10° ^{+2°} / _{-1°}	WLG2-N	—	—
High-precision	5° ^{+3°} / _{-0°}	WLGCA2-N	—	—

Actuator		Adjustable roller lever 	Adjustable rod lever: 25 to 140mm 	Adjustable rod lever: 350 to 380mm 	Rod spring lever 
Item	Pretravel (PT)	Model	Model	Model	Model
Basic	15±5°	WLCA12-N	WLCL-N	WLCAL4-N	WLCAL5-N
	25±5°	WLCA12-2-N	WLCL-2-N	—	—
	MAX20°	WLCA12-2N-N	WLCL-2N-N	—	—
High-sensitivity	10° ^{+2°} / _{-1°}	WLG12-N	WLGL-N	—	—



Actuator		Fork lever lock 	Fork lever lock 	Fork lever lock 	Fork lever lock 
Item	Movement until the lever reverses	Model	Model	Model	Model
Protective	50±5°	WLCA32-41-N	WLCA32-42-N	WLCA32-43-N	WLCA32-44-N



Switches with Plunger Actuators

Actuator		Sealed top plunger 	Sealed top-roller plunger 	Sealed top-ball plunger 
Item	Pretravel (PT)	Model	Model	Model
Basic	1.7 mm	WLD18-N	WLD28-N	WLD38-N

Actuator		Horizontal plunger 	Horizontal-roller plunger 	Horizontal-ball plunger 
Item	Pretravel (PT)	Model	Model	Model
Basic	2.8 mm	WLSD-N	WLSD2-N	WLSD3-N

Switches with Flexible Rod Actuators



Actuator		Coil spring (spring diameter: 6.5) 	Coil spring (spring diameter: 4.8) 
Item	Pretravel (PT)	Model	Model
Basic	20±10 mm	WLNJ-N	WLNJ-30-N

Actuator		Resin rod (rod diameter: 8) 	Steel wire (wire diameter: 1) 
Item	Pretravel (PT)	Model	Model
Basic	40±20 mm	WLNJ-2-N	WLNJ-S2-N



General-purpose Switches

Operation Indicator Switches



Switches with Lever Actuators



Actuator			Roller lever: R38 	Roller lever: R50 	Roller lever: R63 
Indicator	Item	Pretravel (PT)	Model	Model	Model
Neon lamp	Basic	15±5°	WLCA2-LE-N	WLCA2-7LE-N	WLCA2-8LE-N
		25±5°	WLCA2-2LE-N	—	—
		MAX20°	WLCA2-2NLE-N	—	—
	High-sensitivity	10° $\begin{smallmatrix} +2^\circ \\ -1^\circ \end{smallmatrix}$	WLG2-LE-N	—	—
	High-precision	5° $\begin{smallmatrix} +2^\circ \\ 0^\circ \end{smallmatrix}$	WLGCA2-LE-N	—	—
LED	Basic	15±5°	WLCA2-LD-N	WLCA2-7LD-N	WLCA2-8LD-N
		25±5°	WLCA2-2LD-N	—	—
		MAX20°	WLCA2-2NLD-N	—	—
	High-sensitivity	10° $\begin{smallmatrix} +2^\circ \\ -1^\circ \end{smallmatrix}$	WLG2-LD-N	—	—
	High-precision	5° $\begin{smallmatrix} +2^\circ \\ 0^\circ \end{smallmatrix}$	WLGCA2-LD-N	—	—

Actuator			Adjustable roller lever: 	Adjustable rod lever: 25 to 140mm 	Adjustable rod lever: 350 to 380mm 	Rod spring lever 
Indicator	Item	Pretravel (PT)	Model	Model	Model	Model
Neon lamp	Basic	15±5°	WLCA12-LE-N	WLCL-LE-N	WLCAL4-LE-N	WLCAL5-LE-N
		25±5°	WLCA12-2LE-N	WLCL-2LE-N	—	—
		MAX20°	WLCA12-2NLE-N	WLCL-2NLE-N	—	—
	High-sensitivity	10° $\begin{smallmatrix} +2^\circ \\ -1^\circ \end{smallmatrix}$	WLG12-LE-N	WLGL-LE-N	—	—
LED	Basic	15±5°	WLCA12-LD-N	WLCL-LD-N	WLCAL4-LD-N	WLCAL5-LD-N
		25±5°	WLCA12-2LD-N	WLCL-2LD-N	—	—
		MAX20°	WLCA12-2NLD-N	WLCL-2NLD-N	—	—
	High-sensitivity	10° $\begin{smallmatrix} +2^\circ \\ -1^\circ \end{smallmatrix}$	WLG12-LD-N	WLGL-LD-N	—	—



Actuator			Fork lever lock 	Fork lever lock 	Fork lever lock 
Indicator	Item	Movement until the lever reverses	Model	Model	Model
Neon lamp	Basic	50±5°	WLCA32-41LE-N	WLCA32-42LE-N	WLCA32-43LE-N
LED	Basic	50±5°	WLCA32-41LD-N	—	WLCA32-43LD-N



Switches with Plunger Actuators

Actuator			Sealed top plunger 	Sealed top-roller plunger 	Sealed top-ball plunger 
Indicator	Item	Pretravel (PT)	Model	Model	Model
Neon lamp	Basic	1.7 mm	WLD18-LE-N	WLD28-LE-N	WLD38-LE-N
LED	Basic	1.7 mm	WLD18-LD-N	WLD28-LD-N	WLD38-LD-N

Actuator			Horizontal plunger 	Horizontal-roller plunger 	Horizontal-ball plunger 
Indicator	Item	Pretravel (PT)	Model	Model	Model
Neon lamp	Basic	2.8 mm	WLS2-LE-N	WLS2-LE-N	WLS3-LE-N
LED	Basic	2.8 mm	WLS2-LD-N	WLS2-LD-N	WLS3-LD-N

Switches with Flexible Rod Actuators

Actuator			Coil spring (spring diameter: 6.5) 	Coil spring (spring diameter: 4.8) 
Indicator	Item	Pretravel (PT)	Model	Model
Neon lamp	Basic	20±10 mm	WLNJ-LE-N	WLNJ-30LE-N
LED	Basic	20±10 mm	WLNJ-LD-N	WLNJ-30LD-N

Actuator			Resin rod (rod diameter: 8) 	Steel wire (wire diameter: 1) 
Indicator	Item	Pretravel (PT)	Model	Model
Neon lamp	Basic	40±20 mm	WLNJ-2LE-N	WLNJ-S2LE-N
LED	Basic	40±20 mm	WLNJ-2LD-N	WLNJ-S2LD-N

General-purpose Switches

Sensor I/O Connector Switches

Switches with Direct-wired Connectors

				Actuator	Roller lever: R38 		
				Item	Basic	High-sensitivity	High-precision
Connector shape	Built-in switch type	Voltage	Wiring locations	Connector pin No.	Model	Model	Model
Threaded (M12)	General-purpose	AC	NO only	NO ③ ④	WLCA2-LDK13A-N	—	—
			NC + NO	NC ① ② NO ③ ④	WLCA2-LDK43A-N	—	—
		DC	NO only	NO ③ ④	WLCA2-LDK13-N	WLG2-LDK13-N	WLGCA2-LDK13-N
			NC + NO	NC ① ② NO ③ ④	WLCA2-LDK43-N	WLG2-LDK43-N	WLGCA2-LDK43-N
	Airtight	AC	NO only	NO ③ ④	WLCA2-55LDK13-N	WLG2-55LDK13-N	WLGCA2-55LDK13-N
			NC + NO	NC ① ② NO ③ ④	WLCA2-55LDK43-N	WLG2-55LDK43-N	WLGCA2-55LDK43-N

Switches with Pre-wired Connectors

				Actuator	Roller lever R38 		
				Item	Basic	High-sensitivity	High-precision
Connector shape	Built-in switch type	Voltage	Wiring locations	Connector pin No.	Model	Model	Model
Threaded (M12)	General-purpose	DC	NO only	NO ③ ④	WLCA2-LD-M1J-N	WLG2-LD-M1J-N	WLGCA2-LD-M1J-N
				NO ① ④	WLCA2-LD-M1GJ-N	WLG2-LD-M1GJ-N	WLGCA2-LD-M1GJ-N
			NC only	NC ② ③	WLCA2-LD-M1JB-N	WLG2-LD-M1JB-N	—
			NC + NO	NC ① ② NO ③ ④	WLCA2-LD-DGJ-N	WLG2-LD-DGJ-N	WLGCA2-LD-DGJ-N
	Airtight		NO only	NO ④ ③ NC ②	WLCA2-LD-DK1EJ-N	WLG2-LD-DK1EJ-N	—
				NO ③ ④	WLCA2-55LD-M1J-N	—	WLGCA2-55LD-M1J-N
			NO ① ④	WLCA2-55LD-M1GJ-N	WLG2-55LD-M1GJ-N	WLGCA2-55LD-M1GJ-N	
			NC only	NC ② ③	WLCA2-55LD-M1JB-N	WLG2-55LD-M1JB-N	WLGCA2-55LD-M1JB-N
			NC + NO	NC ① ② NO ③ ④	WLCA2-55LD-DGJ-N	WLG2-55LD-DGJ-N	WLGCA2-55LD-DGJ-N
			NO only	NO ④ ③ NC ②	WLCA2-55LD-DK1EJ-N	WLG2-55LD-DK1EJ-N	—
Smartclick	General-purpose	NO only	NO ③ ④	—	WLG2-LD-M1TJ-N	—	
		NO only	NC ② ③	—	WLG2-LD-M1TJB-N	—	

Note: The standard cable length for a pre-wired connector is 0.3 m. Contact your OMRON representative for information on other cable lengths.

Contact Forms

Screw Terminal Switches

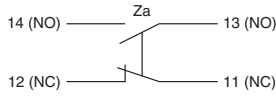

Screw Terminal Switches

Indicator-equipped (Light-ON when Not Operating) Switches *1

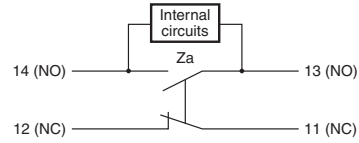

Direct-wired Connectors/Pre-wired Connectors

Indicator-equipped (Light-ON when Not Operating) Switches *1

AC

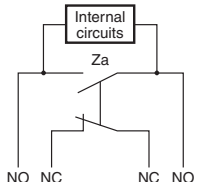

WL□□K13A-N	④	—	—	③
WL□□K43A-N	④	①	②	③
WL□□AGJ-N	④	①	②	③

①②③④ indicate the connector pin number.

DC

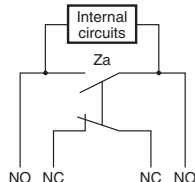

WL□□K13-N	④	—	—	③
WL□□M1J-N	④	—	—	③
WL□□M1TJ-N	④	—	—	①
WL□□M1GJ-N	④	—	—	①
WL□□M1TGJ-N	④	—	—	①
WL□□M1JB-N	—	③	②	—
WL□□M1TJB-N	—	③	②	—
WL□□K43-N	④	①	②	③
WL□□DGJ-N	④	①	②	③
WL□□DTGJ-N	④	①	②	③

①②③④ indicate the connector pin number.

Connector Pin Layout Diagram

AC

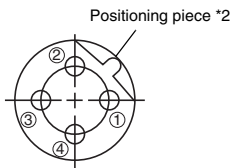

DC

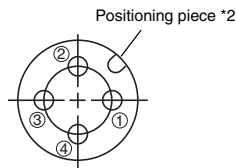

Note: Leakage current from indicator circuit may cause load malfunction (i.e., the load may remain ON). Make sure that the load operating current is higher than the leakage current. For countermeasures, refer to technical support on your OMRON website.

*1. Light-ON when not operating means the indicator is lit when the actuator is free and is not light when the Switch contacts (NO) close when the actuator rotates or is pushed down.

*2. The position of the positioning piece is not always the same. If using an L-shaped connector causes problems in application, use a straight connector.

Connecting Sensor I/O connector cable (Socket)

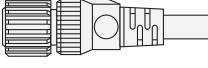
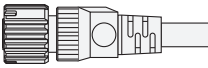

Type	AC/DC Type	Number of cable cores	Cable length L (m)	Model	Applicable limit switch models	
M12 Screw (Straight) 	AC	2	2 m	XS2F-A421-DB0-F	WL□□K13A-N	
			5 m	XS2F-A421-GB0-F		
		4	2 m	XS2F-A421-D90-F	WL□□K43A-N WL□□AGJ-N	
			5 m	XS2F-A421-G90-F		
	DC	2	2 m	XS2F-D421-DD0	WL□□K13-N WL□□M1J-N	
			5 m	XS2F-D421-GD0		
			4	2 m	XS2F-D421-DA0-F	WL□□M1GJ□-N
				5 m	XS2F-D421-GA0-F	
DC	4	2 m	XS2F-D421-D80-F	WL□□K43-N WL□□M1JB-N WL□□DGJ-N		
		5 m	XS2F-D421-G80-F			
M12 Smart click type (Straight) 	DC	4	2 m	XS5F-D421-D80-F	WL□□M1TJ-N WL□□M1TJB-N	
			5 m	XS5F-D421-G80-F		

Dimensions (Unit: mm)

XS2F-□421-□□0-□

XS2F-D421-□D0

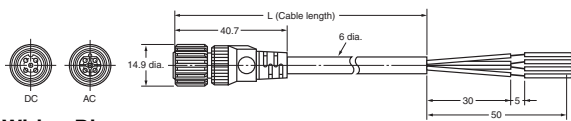

Wiring Diagram

AC/DC Type	Two-core model		Four-core model	
	Model	Wiring Diagram	Model	Wiring Diagram
AC	XS2F-A421-DB0-F XS2F-A421-GB0-F		XS2F-A421-D90-F XS2F-A421-G90-F	
	XS2F-D421-DD0 XS2F-D421-GD0		XS2F-D421-D80-F XS2F-D421-G80-F	
DC	XS2F-D421-DA0-F XS2F-D421-GA0-F			

XS5F-D421-□80-F

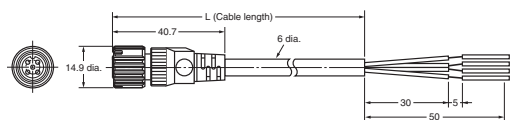



Wiring Diagram





AC/DC Type	Four-core model	
	Model	Wiring Diagram
DC	XS5F-D421-D80-F XS5F-D421-G80-F	

Environment-resistant Switches

Standard Switches

		Actuator	Roller lever R38 	Adjustable roller lever 	Adjustable rod lever 25 to 140mm 	
Item		Pretravel (PT)	Model	Model	Model	
Airtight seal	Basic	15±5°	WLCA2-55-N	WLCA12-55-N	WLCL-55-N	
		25±5°	WLCA2-255-N	—	—	
		MAX20°	WLCA2-2N55-N	—	—	
	High-sensitivity	10° $\begin{smallmatrix} +2 \\ -1 \end{smallmatrix}$	WLG2-55-N	—	—	
	High-precision	5° $\begin{smallmatrix} +2 \\ 0 \end{smallmatrix}$	WLGCA2-55-N	—	—	
Hermetic seal	Molded terminals, -139 models	Basic	15±5°	WLCA2-139-N	WLCA12-139-N	WLCL-139-N
			25±5°	WLCA2-2139-N	—	—
			MAX20°	WLCA2-2N139-N	—	—
		High-sensitivity	10° $\begin{smallmatrix} +2 \\ -1 \end{smallmatrix}$	WLG2-139-N	—	—
	High-precision	5° $\begin{smallmatrix} +2 \\ 0 \end{smallmatrix}$	WLGCA2-139-N	—	—	
	Molded terminals, -140 models	Basic	15±5°	WLCA2-140-N	WLCA12-140-N	WLCL-140-N
			25±5°	—	—	—
			MAX20°	WLCA2-2N140-N	—	—
		High-sensitivity	10° $\begin{smallmatrix} +2 \\ -1 \end{smallmatrix}$	WLG2-140-N	—	—
	High-precision	5° $\begin{smallmatrix} +2 \\ 0 \end{smallmatrix}$	—	—	—	
	Molded terminals, -141 models	Basic	15±5°	WLCA2-141-N	WLCA12-141-N	—
			25±5°	—	—	—
MAX20°			—	—	—	
High-sensitivity		10° $\begin{smallmatrix} +2 \\ -1 \end{smallmatrix}$	WLG2-141-N	—	—	
High-precision	5° $\begin{smallmatrix} +2 \\ 0 \end{smallmatrix}$	WLGCA2-141-N	—	—		
Anti-coolant	Basic	15±5°	WLCA2-RP60-N	WLCA12-RP60-N	WLCL-RP60-N	
		25±5°	WLCA2-2RP60-N	—	—	
		MAX20°	—	—	—	
	High-sensitivity	10° $\begin{smallmatrix} +2 \\ -1 \end{smallmatrix}$	WLG2-RP60-N	—	—	
High-precision	5° $\begin{smallmatrix} +2 \\ 0 \end{smallmatrix}$	WLGCA2-RP60-N	—	—		
Heat-resistant	Basic	15±5°	WLCA2-TH-N	WLCA12-TH-N	WLCL-TH-N	
		25±5°	WLCA2-2TH-N	WLCA12-2TH-N	WLCL-2TH-N	
		MAX20°	WLCA2-2NTH-N	WLCA12-2NTH-N	WLCL-2NTH-N	
	High-sensitivity	10° $\begin{smallmatrix} +2 \\ -1 \end{smallmatrix}$	WLG2-TH-N	WLG12-TH-N	WLGL-TH-N	
	High-precision	5° $\begin{smallmatrix} +2 \\ 0 \end{smallmatrix}$	WLGCA2-TH-N	—	—	
Low-temperature	Basic	15±5°	WLCA2-TC-N	WLCA12-TC-N	WLCL-TC-N	
		25±5°	WLCA2-2TC-N	WLCA12-2TC-N	WLCL-2TC-N	
		MAX20°	WLCA2-2NTC-N	WLCA12-2NTC-N	WLCL-2NTC-N	
	High-sensitivity	10° $\begin{smallmatrix} +2 \\ -1 \end{smallmatrix}$	WLG2-TC-N	WLG12-TC-N	WLGL-TC-N	
	High-precision	5° $\begin{smallmatrix} +2 \\ 0 \end{smallmatrix}$	WLGCA2-TC-N	—	—	
Corrosion-proof	Basic	15±5°	WLCA2-RP-N	WLCA12-RP-N	WLCL-RP-N	
		25±5°	—	—	—	
		MAX20°	—	—	—	
	High-sensitivity	10° $\begin{smallmatrix} +2 \\ -1 \end{smallmatrix}$	WLG2-RP-N	—	—	
High-precision	5° $\begin{smallmatrix} +2 \\ 0 \end{smallmatrix}$	WLGCA2-RP-N	—	—		
Weather-proof	Basic	15±5°	WLCA2-P1-N	WLCA12-P1-N	WLCL-P1-N	
		25±5°	—	—	—	
		MAX20°	—	—	—	
	High-sensitivity	10° $\begin{smallmatrix} +2 \\ -1 \end{smallmatrix}$	WLG2-P1-N	WLG12-P1-N	WLGL-P1-N	

Note: The maximum cable length for a Hermetic Switch is 5 m.



Actuator		Sealed top-roller plunger 	Horizontal plunger 	Horizontal-roller plunger 	Coil spring (spring diameter: 6.5) 	Resin rod (rod diameter: 8) 
		Model	Model	Model	Model	Model
Airtight		WLD28-55-N	WLS28-55-N	WLS28-55-N	WLNJ-55-N	WLNJ-255-N
Hermetic	Molded terminals, -139 models	WLD28-139-N	WLS28-139-N	WLS28-139-N	WLNJ-139-N	WLNJ-2139-N
	Molded terminals, -140 models	WLD28-140-N	—	WLS28-140-N	WLNJ-140-N	WLNJ-2140-N
	Anti-coolant	WLD28-RP60-N	WLS28-RP60-N	WLS28-RP60-N	WLNJ-RP60-N	WLNJ-2RP60-N
Heat-resistant		WLD28-TH-N	WLS28-TH-N	WLS28-TH-N	WLNJ-TH-N	—
Low-temperature		—	WLS28-TC-N	WLS28-TC-N	WLNJ-TC-N	—
Corrosion-proof		WLD28-RP-N	WLS28-RP-N	WLS28-RP-N	WLNJ-RP-N	WLNJ-2RP-N





Note: The maximum cable length for a Hermetic Switch is 5 m.

Environment-resistant Switches

Operation indicator Switches

Airtight Switches

		Actuator		Roller lever: R38 	Adjustable roller lever 	Adjustable rod lever: 25 to 140mm 
Indicator	Item	Pretravel (PT)	Model	Model	Model	Model
Neon lamp	Basic	15±5°	WLCA2-55LE-N	WLCA12-55LE-N	—	—
		25±5°	WLCA2-255LE-N	—	—	—
		MAX20°	WLCA2-2N55LE-N	—	—	—
	High-sensitivity	10° $\begin{smallmatrix} +2 \\ -1 \end{smallmatrix}$	WLG2-55LE-N	—	—	—
	High-precision	5° $\begin{smallmatrix} +2 \\ 0 \end{smallmatrix}$	WLGCA2-55LE-N	—	—	—
LED	Basic	15±5°	WLCA2-55LD-N	WLCA12-55LD-N	WLCL-55LD-N	—
		25±5°	WLCA2-255LD-N	—	—	—
		MAX20°	WLCA2-2N55LD-N	—	—	—
	High-sensitivity	10° $\begin{smallmatrix} +2 \\ -1 \end{smallmatrix}$	WLG2-55LD-N	—	—	—
	High-precision	5° $\begin{smallmatrix} +2 \\ 0 \end{smallmatrix}$	WLGCA2-55LD-N	—	—	—





Actuator		Sealed top-roller plunger 	Horizontal plunger 	Horizontal-roller plunger 	Coil spring (spring diameter: 6.5) 	Resin rod (rod diameter: 8) 
Indicator	Item	Model	Model	Model	Model	Model
Neon lamp	Basic	WLD28-55LE-N	—	—	—	—
LED	Basic	WLD28-55LD-N	WLS28-55LD-N	WLS28-55LD-N	WLNJ-55LD-N	WLNJ-255LD-N

Hermetic Switches



		Actuator		Roller lever: R38 	
		Wiring specification	NC wiring	NO wiring	
Item		Pretravel (PT)	Model	Model	
Molded terminals, -139 models	Basic	15±5°	WLCA2-139LD2-N	WLCA2-139LD3-N	
		25±5°	WLCA2-2139LD2-N	WLCA2-2139LD3-N	
		MAX20°	—	—	
	High-sensitivity	10° $\begin{smallmatrix} +2 \\ -1 \end{smallmatrix}$	—	WLG2-139LD3-N	
	High-precision	5° $\begin{smallmatrix} +2 \\ 0 \end{smallmatrix}$	WLGCA2-139LD2-N	WLGCA2-139LD3-N	
Molded terminals, -141 models	Basic	15±5°	WLCA2-141LD2-N	WLCA2-141LD3-N	
		25±5°	—	—	
		MAX20°	—	—	
	High-sensitivity	10° $\begin{smallmatrix} +2 \\ -1 \end{smallmatrix}$	WLG2-141LD2-N	WLG2-141LD3-N	
	High-precision	5° $\begin{smallmatrix} +2 \\ 0 \end{smallmatrix}$	—	—	
Anti-coolant	Basic	15±5°	WLCA2-RP60LD2-N	WLCA2-RP60LD3-N	
		25±5°	WLCA2-2RP60LD2-N	WLCA2-2RP60LD3-N	
		MAX20°	—	—	
	High-sensitivity	10° $\begin{smallmatrix} +2 \\ -1 \end{smallmatrix}$	WLG2-RP60LD2-N	WLG2-RP60LD3-N	
	High-precision	5° $\begin{smallmatrix} +2 \\ 0 \end{smallmatrix}$	WLGCA2-RP60LD2-N	WLGCA2-RP60LD3-N	

Note: The maximum cable length for a Hermetic Switch is 5 m.

Spatter-prevention Switches

Actuator			Roller lever: R38 		Sealed top-roller plunger 
			Double Nut Lever 	Allen-head Lever 	
Indicator	Item	Pretravel (PT)	Model	Model	Model
Neon lamp	Basic	15±5°	WLCA2-LEAS-N	WLCA2-LES-N	WLD28-LES-N
	High-sensitivity	10° ^{+2°} / _{-1°}	WLG2-LEAS-N	WLG2-LES-N	—
	High-precision	5° ^{+2°} / _{0°}	—	WLGCA2-LES-N	—
LED	Basic	15±5°	WLCA2-LDAS-N	WLCA2-LDS-N	WLD28-LDS-N
	High-sensitivity	10° ^{+2°} / _{-1°}	WLG2-LDAS-N	WLG2-LDS-N	—
	High-precision	5° ^{+2°} / _{0°}	—	WLGCA2-LDS-N	—

Long-life Switches

Item			Operation indicator (LED) *1		
			Basic 15±5°	High-sensitivity 10° ^{+2°} / _{-1°}	High-precision 5° ^{+2°} / _{0°}
Actuator			Model	Model	Model
 Roller lever: R38, screw terminals			WLMCA2-LD-N	WLMG2-LD-N	WLMGCA2-LD-N
 Roller lever, direct-wired connector	2 conductors	AC	WLMCA2-LDK13A-N	WLMG2-LDK13A-N	WLMGCA2-LDK13A-N
		DC	WLMCA2-LDK13-N	WLMG2-LDK13-N	WLMGCA2-LDK13-N
	4 conductors	AC	WLMCA2-LDK43A-N	WLMG2-LDK43A-N	—
		DC	WLMCA2-LDK43-N	WLMG2-LDK43-N	WLMGCA2-LDK43-N
 Roller lever, pre-wired connector *2	2 conductors	DC	WLMCA2-LD-M1J-N	WLMG2-LD-M1J-N	WLMGCA2-LD-M1J-N
	4 conductors	DC	WLMCA2-LD-DGJ-N	WLMG2-LD-DGJ-N	—







*1. The default setting is light-ON when not operating (NO wiring).
Turn the lamp holder by 180° to change the setting to light-ON when operating (NC wiring).
(Ask your OMRON representative for information on 2-conductor models.)

*2. With 0.3-m cable.

Individual Parts

Switches without Levers, Heads, and Actuators

General-purpose Parts

Actuator	Item	Pretravel (PT)	Set	Switch without levers	Head *1 (with Actuators)	Actuator only *2
				Model	Model	Model
Roller lever 	Basic	15±5°	WLCA2-N	WLRCA2-N	WL-1H1100-N	WL-1A100
		25±5°	WLCA2-2-N	WLRCA2-2-N	WL-3H1100-N	
		MAX20°	WLCA2-2N-N	WLRCA2-2N-N	WL-1H1100-N	
	High-sensitivity	10° ±2°	WLG2-N	WLRG2-N	WL-2H1100-N	
Adjustable roller lever 	Basic	15±5°	WLCA12-N	WLRCA2-N	WL-1H2100-N	WL-2A100
		25±5°	WLCA12-2-N	WLRCA2-2-N	WL-3H2100-N	
		MAX20°	WLCA12-2N-N	WLRCA2-2N-N	WL-1H2100-N	
	High-sensitivity	10° ±2°	WLG12-N	WLRG2-N	WL-2H2100-N	
Variable rod lever 	Basic	15±5°	WLCL-N	WLRCA2-N	WL-1H4100-N	WL-4A100
		25±5°	WLCL-2-N	WLRCA2-2-N	WL-3H4100-N	
		MAX20°	WLCL-2N-N	WLRCA2-2N-N	WL-1H4100-N	
	High-sensitivity	10° ±2°	WLGL-N	WLRG2-N	WL-2H4100-N	
Fork lever lock 	Basic	MAX55°	WLCA32-41-N	WLRCA32-N	WL-5H5100-N	WL-5A100
			WLCA32-42-N		WL-5H5102-N	WL-5A102
			WLCA32-43-N		WL-5H5104-N	WL-5A104
			WLCA32-44-N		WL-5H5104-N	WL-5A104
Top plunger 	Basic	MAX 1.7 mm	WLD18-N	—	WL-7H100-N	—
			WLD28-N		WL-7H400-N	—
			WLD38-N		WL-7H300-N	—
Horizontal plunger 	Basic	MAX 2.8 mm	WLS2-N	—	WL-8H100-N	—
			WLS2-N		WL-8H200-N	—
			WLS3-N		WL-8H300-N	—
Flexible rod 	Basic	20±10 mm	WLNJ-N	—	WL-9H100-N	—
			WLNJ-30-N		WL-9H200-N	—
		40±20 mm	WLNJ-2-N		WL-9H300-N	—
			WLNJ-S2-N		WL-9H400-N	—

*1. The heads are not compatible with WL-series switches.

*2. The same actuators can be used for both WL and WL-N switches.

Spatter-prevention Parts



Actuator	Lever Type	Item	Set	Switch without levers	Head *1 (with Actuators)	Actuator only *2
				Model	Model	Model
Roller lever 	Allen-head bolt lever	Basic	WLCA2-LES-N	WLRCA2-LES-N	WL-1H1100S-N	WL-1A103S
		High-sensitivity	WLCA2-LDS-N	WLRCA2-LDS-N		
	Double nut lever	Basic	WLCA2-LEAS-N	WLRCA2-LES-N	WL-2H1100S-N	WL-1A105S
		High-sensitivity	WLCA2-LDAS-N	WLRG2-LDS-N		

*1. The heads are not compatible with WL-series switches.

*2. The same actuators can be used for both WL and WL-N switches.



Covers with Indicators (See Note.)

General-purpose Parts

Item	Cover	Cover only *
		Model
Neon lamp 		WL-LE-N
LED 		WL-LD-N

* The covers are not compatible with WL-series switches.

Spatter-prevention Parts

Item	Cover	Cover only *
		Model
Neon lamp 		WL-LES-N
LED 		WL-LDS-N

Note: The default setting is for light-ON when not operating.
Turn the lamp holder by 180° to change the setting to light-ON when operating.

General-purpose/ Environment-resistant Switches

Ratings

Screw Terminals

Item	Rated voltage (V)	Non-inductive load (A)				Inductive load (A)			
		Resistive load		Lamp load		Inductive load		Motor load	
		NC	NO	NC	NO	NC	NO	NC	NO
Basic or high-precision	AC	125	10	3	1.5	10	5	2.5	
		250	10	2	1	10	3	1.5	
		500	10	1.5	0.8	3	1.5	0.8	
	DC	8	10	6	3	10	6	6	
		14	10	6	3	10	6	6	
		30	6	4	3	6	4	4	
125	0.8	0.2	0.2	0.8	0.8	0.2	0.2		
	250	0.4	0.1	0.1	0.4	0.1	0.1		
High-sensitivity Switches	AC	125	5	—	—	—	—		
		250	5	—	—	—	—		
	DC	125	0.4	—	—	—	—		
		250	0.2	—	—	—	—		

- Note:**
- The above figures are for steady-state currents.
 - Inductive loads have a power factor of 0.4 min. (AC) and a time constant of 7 ms max. (DC).
 - A lamp load has an inrush current of 10 times the steady-state current.
 - A motor load has an inrush current of 6 times the steady-state current.
 - For PC loads, use the microload models.

Inrush current	NC	30 A max.(15 A max. *)
	NO	20 A max.(10 A max. *)

* For high-sensitivity switches.

Minimum applicable load	5 VDC 1 mA, resistive load, P level
-------------------------	-------------------------------------

Operation indicator Switches

Model	Item	Max. rated voltage	Leakage current (mA)
WL-LE-N	Neon lamp	125 AC	Approx. 0.6
		250 AC	Approx. 1.9
WL-LD-N	LED	10 to 24 VAC/DC	Approx. 0.4
		115 VAC/DC	Approx. 0.5

Characteristics

Degree of protection	IP67	
Durability *1	Mechanical	15,000,000 operations min. *2
	Electrical	750,000 operations min. *3
Operating speed	1 mm/s to 1 m/s (in case of WLCA2-N)	
Operating frequency	Mechanical	120 operations/minute min.
	Electrical	30 operations/minute min.
Rated frequency	50/60 Hz	
Insulation resistance	100 MΩ min. (at 500 VDC)	
Contact resistance	25 mΩ max. (initial value for the built-in switch when tested alone)	
Dielectric strength	Between terminals of the same polarity	1,000 VAC (600 VAC), 50/60 Hz for 1 min
	Between currentcarrying metal part and ground	2,200 VAC (1,500 VAC), 50/60 Hz for 1 min *4
	Between each terminal and non-currentcarrying metal part	2,200 VAC (1,500 VAC), 50/60 Hz for 1 min *4
Vibration resistance	Malfuction	10 to 55 Hz, 1.5-mm double amplitude *5
Shock resistance	Destruction	1,000 m/s ² max.
	Malfuction	300 m/s ² *5
Ambient operating temperature	-10 to +80°C (with no icing) *6	
Ambient operating humidity	35% to 95% RH	
Weight	Approx. 255 g (in case of WLCA2-N)	

- Note:**
- The above figures are initial values.
 - The figures in parentheses for dielectric strength are those for the high-sensitivity switches models.
 - The values are calculated at an operating temperature of +5°C to +35°C and an operating humidity of 40% to 70% RH. Contact your OMRON sales representative for more detailed information on other operating environments.
 - High-sensitivity switches and switches with flexible rod actuators: 10 million operations min. 500,000 operations min. for weather-proof models.
 - Durability is 500,000 operations min. for high-sensitivity models. 500,000 operations min. for weather-proof models. Contact your OMRON representative for information on environment-resistant switches.
 - Switches with Connectors: 1,500 V.
 - Except switches with flexible rod actuators.
 - For low-temperature models this is -40°C to +40°C (with no icing). For heat-resistant models the range is +5°C to +120°C.

Spatter-prevention Switches

Ratings

Screw Terminals

Item	Rated voltage (V)	Non-inductive load (A)				Inductive load (A)			
		Resistive load		Lamp load		Inductive load		Motor load	
		NC	NO	NC	NO	NC	NO	NC	NO
WL□-LES-N (Without high-sensitivity overtravel models)	AC 125	10	3	1.5	10	5	2.5		
	250	10	2	1	10	3	1.5		
WL□-LDS-N (Without high-sensitivity overtravel models)	AC 115	10	3	1.5	10	5	2.5		
	DC 12	10	6	3	10		6		
		24	6	4	3	6		4	
	115	0.8	0.2	0.2	0.8		0.2		

- Note:** 1. The above figures are for steady-state currents.
 2. Inductive loads have a power factor of 0.4 min. (AC) and a time constant of 7 ms max. (DC).
 3. A lamp load has an inrush current of 10 times the steady-state current.
 4. A motor load has an inrush current of 6 times the steady-state current.

* Refer to the rating of a General-purpose / Weather-proof Switches type for the rating of a high-sensitivity overtravel type.

Inrush current	NC	30 A max.(15 A max. *)
	NO	20 A max.(10 A max. *)

* For high-sensitivity switches.

Minimum applicable load	5 VDC 1 mA, resistive load, P level
-------------------------	-------------------------------------

Characteristics

Degree of protection	IP67	
Durability *1	Mechanical	15,000,000 operations min. *2
	Electrical	750,000 operations min. (3 A at 250 VAC, resistive load) *3
Operating speed	1 mm/s to 1 m/s (in case of WLCA2-LDS-N)	
Operating frequency	Mechanical	120 operations/minute min.
	Electrical	30 operations/minute min.
Rated frequency	50/60 Hz	
Insulation resistance	100 MΩ min. (at 500 VDC)	
Contact resistance	25 mΩ max. (initial value for the built-in switch when tested alone)	
Dielectric strength	Between terminals of the same polarity	1,000 VAC (600 VAC), 50/60 Hz for 1 min
	Between currentcarrying metal part and ground	2,200 VAC (1,500 VAC), 50/60 Hz for 1 min *4
	Between each terminal and non-currentcarrying metal part	2,200 VAC (1,500 VAC), 50/60 Hz for 1 min *4
Vibration resistance	Malfunction	10 to 55 Hz, 1.5-mm double amplitude
Shock resistance	Destruction	1,000 m/s ² max.
	Malfunction	300 m/s ²
Ambient operating temperature	-10 to +80°C (with no icing)	
Ambient operating humidity	35% to 95% RH	
Weight	Approx. 255 g (in case of WLCA2-LDS-N)	

- Note:** 1. The above figures are initial values.
 2. The figures in parentheses for dielectric strength are those for the highsensitivity overtravel models.
 *1. The values are calculated at an operating temperature of +5°C to +35°C and an operating humidity of 40% to 70% RH. Contact your OMRON sales representative for more detailed information on other operating environments.
 *2. Durability is 10,000,000 operations min. for high-sensitivity models.
 *3. Durability is 500,000 operations min. for high-sensitivity models.
 500,000 operations min. for weather-proof models.
 Contact your OMRON representative for information on Airtight Switches.
 *4. Switches with Connectors: 1,500 V.

Long-life Switches

Ratings
Screw Terminal Switches

Item	Rated voltage (V)	Non-inductive load (A)			Inductive load (A)				
		Resistive load		Lamp load	Inductive load		Motor load		
		NC	NO	NC	NO	NC	NO	NC	NO
Basic or high-precision	115 AC	10	3	1.5	10	5	2.5		
	12 DC	10	6	3	10	6			
	24 DC	6	4	3	6	4			
	115 DC	0.8	0.2	0.2	0.8	0.2			
High-sensitivity	115 AC	5	—	—	—	—			
	115 DC	0.4	—	—	—	—			
Inrush current	NC	30 A max. (15 A max. *)							
	NO	20 A max. (10 A max. *)							

* For high-sensitivity overtravel models.

Minimum applicable load	5 VDC 1 mA, resistive load, P level
-------------------------	-------------------------------------

Direct-wired Connector and Pre-wired Connector Switches

Model	Rated voltage (V)	Non-inductive load (A)			Inductive load (A)				
		Resistive load		Lamp load	Inductive load		Motor load		
		NC	NO	NC	NO	NC	NO	NC	NO
Basic or high-precision	115 AC	3	3	1.5	3	3	2.5		
	12 DC	3	3	3	3	3			
	24 DC	3	3	3	3	3			
	115 DC	0.8	0.2	0.2	0.8	0.2			
High-sensitivity	115 AC	3	—	—	—	—			
	115 DC	0.4	—	—	—	—			

- Note:**
1. The above figures are for steady-state currents.
 2. Inductive loads have a power factor of 0.4 min. (AC) and a time constant of 7 ms max. (DC).
 3. A lamp load has an inrush current of 10 times the steady-state current.
 4. A motor load has an inrush current of 6 times the steady-state current.

Characteristics

Degree of protection	IP67	
Durability *1	Mechanical	30,000,000 operations min.
	Electrical	30,000,000 operations min. (10 mA at 24 VDC, resistive load) 750,000 operations min. (3 A at 115 VAC, resistive load) High-sensitivity Switches: 500,000 operations min. (3 A at 115 VAC, resistive load)
Operating speed	1 mm/s to 1 m/s (for WLMCA2-LD-N)	
Operating frequency	Mechanical	120 operations/minute
	Electrical	30 operations/minute
Rated frequency	50/60 Hz	
Insulation resistance	100 MΩ min. (at 500 VDC)	
Contact resistance	25 mΩ max. (initial value for the built-in switch when tested alone)	
Dielectric strength (50/60 Hz for 1 min)	Between terminals of the same polarity	1,000 VAC (600 VAC), 50/60 Hz for 1 min
	Between current-carrying metal part and ground	2,200 VAC (1,500 VAC), 50/60 Hz for 1 min *2
	Between each terminal and non-current-carrying metal part	2,200 VAC (1,500 VAC), 50/60 Hz for 1 min *2
Vibration resistance	Malfuction	10 to 55 Hz, 1.5-mm double amplitude
Shock resistance	Destruction	1,000 m/s ² max.
	Malfuction	300 m/s ² max.
Ambient operating temperature	-10°C to +80°C (with no icing)	
Ambient operating humidity	35% to 95%RH	
Weight	Approx. 255 g (for WLMCA2-LD-N)	

- Note:**
1. The above figures are initial values.
 2. The figures in parentheses for dielectric strength are for the High-sensitivity Switches.

*1. The values are calculated at an operating temperature of +5°C to +35°C, and an operating humidity of 40% to 70%RH. Contact your OMRON sales representative for more detailed information on other operating environments.

*2. Switches with Connectors: 1,500 V.

General-purpose/ Environment-resistant/ Spatter-prevention Switches

Approved Standards

Agency	Standard	File No.	Approved models
UL	UL508	Contact your OMRON representative for information	Contact your OMRON representative for information
	CSA C22.2 No.14		
TÜV Rheinland	EN60947-5-1		
CCC (CQC)	GB14048.5		

**Approved Standard Ratings
UL/cUL (UL508, CSA C22.2 No.14)**

Specifications			Approved Standards
Indicator	Sensor I/O connectors	Item	
No indicator	No Connector	Basic Switches	A600 1 A, 125 VDC
		High-sensitivity or high-precision	B600 0.5 A, 125 VDC
	Pre-wired Connector (AC)	Basic, high-sensitivity, or high-precision	C300 3 A, 250 VAC
	Pre-wired Connector (DC) Direct-wired Connector (DC)	Basic Switches High-sensitivity or high-precision	1 A, 125 VDC 0.5 A, 125 VDC
Neon lamp	No Connector	Basic Switches	A300 10 A, 250 VAC
		High-sensitivity or high-precision	B300 5 A, 250 VAC
	Pre-wired Connector (AC)	Basic, high-sensitivity, or high-precision	C300 3 A, 250 VAC
LED	No Connector	Basic Switches	A150 10 A, 115 VAC 1 A, 115 VDC
		High-sensitivity or high-precision	B150 5 A, 115 VAC 0.5 A, 115 VDC
	Pre-wired Connector (AC)	Basic, high-sensitivity, or high-precision	C150 3 A, 115 VAC
	Pre-wired Connector (DC) Direct-wired Connector (DC)	Basic Switches High-sensitivity or high-precision	1 A, 115 VDC 0.5 A, 115 VDC

A600 Authentication conditions

Rated voltage	Energizing current	Current (A)		Volt-ampere (VA)	
		Make	Break	Make	Break
120 VAC 240 VAC 480 VAC 600 VAC	10 A	60 30 15 12	6 3 1.5 1.2	7,200	720

B600 Authentication conditions

Rated voltage	Energizing current	Current (A)		Volt-ampere (VA)	
		Make	Break	Make	Break
120 VAC 240 VAC 480 VAC 600 VAC	5 A	30 15 7.5 6	3 1.5 0.75 0.6	3,600	360

C300 Authentication conditions

Rated voltage	Energizing current	Current (A)		Volt-ampere (VA)	
		Make	Break	Make	Break
120 VAC 240 VAC	2.5 A	15 7.5	1.5 0.75	1,800	180

A300 Authentication conditions

Rated voltage	Energizing current	Current (A)		Volt-ampere (VA)	
		Make	Break	Make	Break
120 VAC 240 VAC	10 A	60 30	6 3	7,200	720