



Chipsmall Limited consists of a professional team with an average of over 10 year of expertise in the distribution of electronic components. Based in Hongkong, we have already established firm and mutual-benefit business relationships with customers from,Europe,America and south Asia,supplying obsolete and hard-to-find components to meet their specific needs.

With the principle of “Quality Parts,Customers Priority,Honest Operation,and Considerate Service”,our business mainly focus on the distribution of electronic components. Line cards we deal with include Microchip,ALPS,ROHM,Xilinx,Pulse,ON,Everlight and Freescale. Main products comprise IC,Modules,Potentiometer,IC Socket,Relay,Connector.Our parts cover such applications as commercial,industrial, and automotives areas.

We are looking forward to setting up business relationship with you and hope to provide you with the best service and solution. Let us make a better world for our industry!



## Contact us

Tel: +86-755-8981 8866 Fax: +86-755-8427 6832

Email & Skype: info@chipsmall.com Web: www.chipsmall.com

Address: A1208, Overseas Decoration Building, #122 Zhenhua RD., Futian, Shenzhen, China



Part Number: WP4060GD

Green

### Features

- 1.8mm diameter small size LED lamp.
- Versatile mounting on P.C. board or panel.
- Reliable and rugged.
- RoHS compliant.

### Description

The Green source color devices are made with Gallium Phosphide Green Light Emitting Diode.

### Package Dimensions

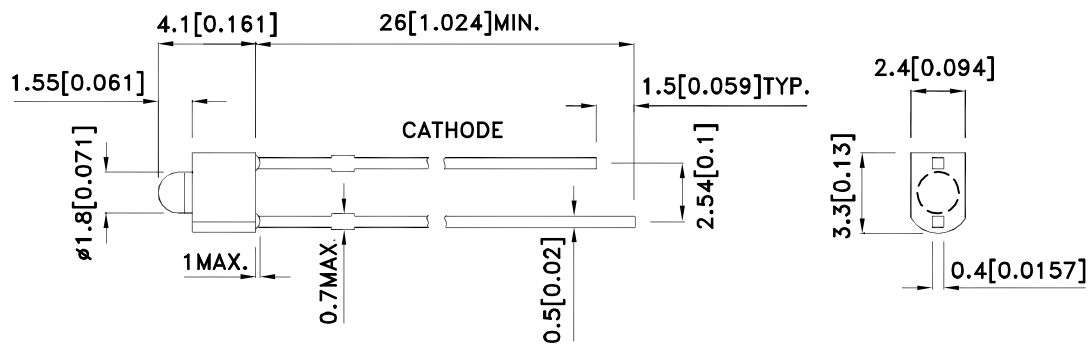

#### Notes:

1. All dimensions are in millimeters (inches).
2. Tolerance is  $\pm 0.25$  (0.01") unless otherwise noted.
3. Lead spacing is measured where the leads emerge from the package.
4. The specifications, characteristics and technical data described in the datasheet are subject to change without prior notice.



## Selection Guide

Part No.	Dice	Lens Type	Iv (mcd) [2] @ 10mA		Viewing Angle [1]
			Min.	Typ.	2θ1/2
WP4060GD	Green (GaP)	Green Diffused	6	12	70°

Notes:

1. θ1/2 is the angle from optical centerline where the luminous intensity is 1/2 of the optical peak value.
2. Luminous intensity/ luminous Flux: +/-15%.

## Electrical / Optical Characteristics at TA=25°C

Symbol	Parameter	Device	Typ.	Max.	Units	Test Conditions
λ <sub>peak</sub>	Peak Wavelength	Green	565		nm	I <sub>F</sub> =20mA
λ <sub>D</sub> [1]	Dominant Wavelength	Green	568		nm	I <sub>F</sub> =20mA
Δλ <sub>1/2</sub>	Spectral Line Half-width	Green	30		nm	I <sub>F</sub> =20mA
C	Capacitance	Green	15		pF	V <sub>F</sub> =0V;f=1MHz
V <sub>F</sub> [2]	Forward Voltage	Green	2.2	2.5	V	I <sub>F</sub> =20mA
I <sub>R</sub>	Reverse Current	Green		10	uA	V <sub>R</sub> = 5V

Notes:

- 1.Wavelength: +/-1nm.
2. Forward Voltage: +/-0.1V.

## Absolute Maximum Ratings at TA=25°C

Parameter	Green	Units
Power dissipation	62.5	mW
DC Forward Current	25	mA
Peak Forward Current [1]	140	mA
Reverse Voltage	5	V
Operating/Storage Temperature	-40°C To +85°C	
Lead Solder Temperature [2]	260°C For 3 Seconds	
Lead Solder Temperature [3]	260°C For 5 Seconds	

Notes:

1. 1/10 Duty Cycle, 0.1ms Pulse Width.
2. 2mm below package base.
3. 5mm below package base.



Green

WP4060GD

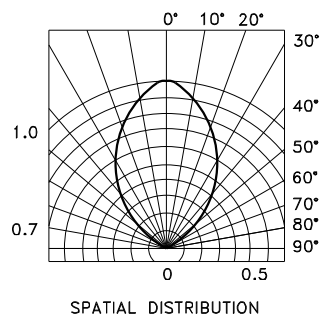
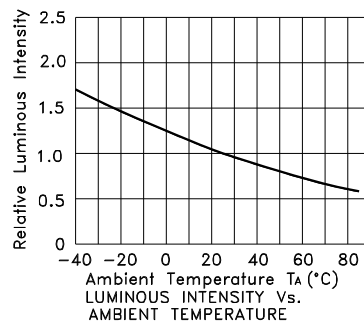
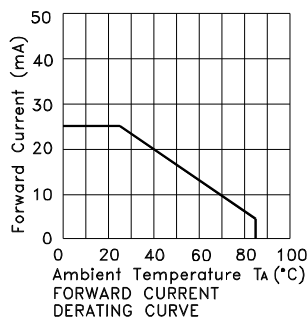
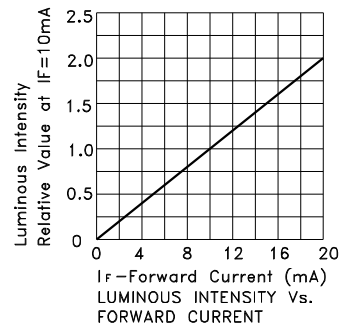
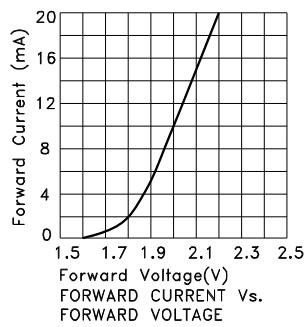

# Kingbright

## PACKING & LABEL SPECIFICATIONS

## WP4060GD

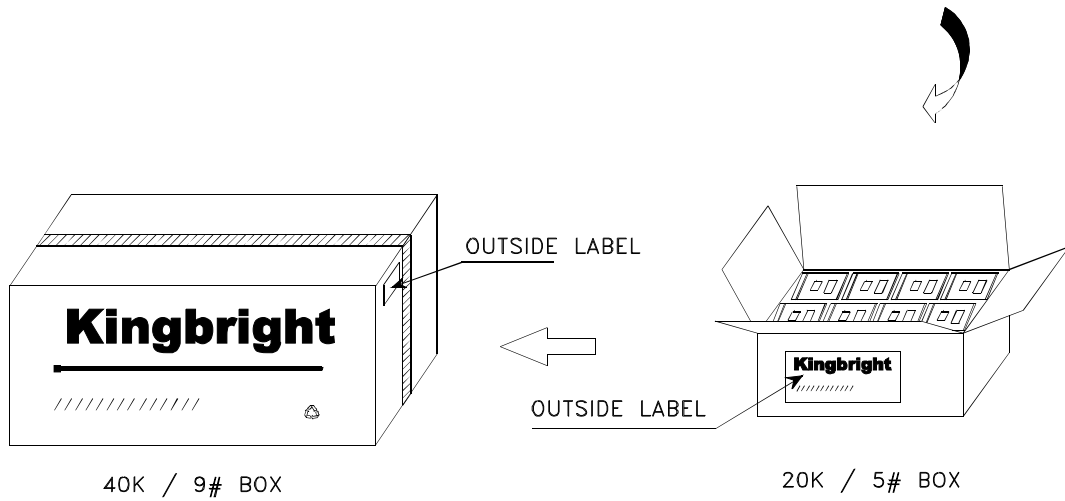
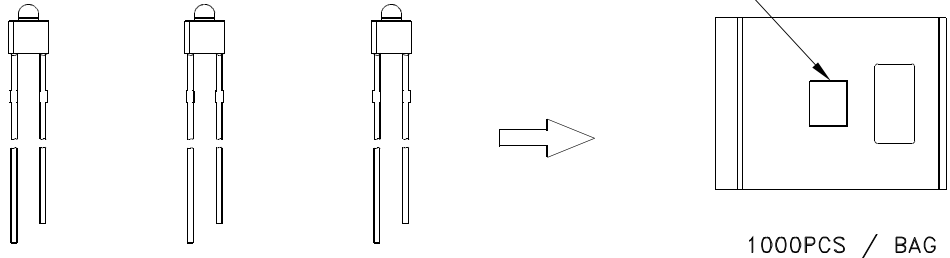

# Kingbright

---

P/N0: WP4060xxx

QTY: 1000 pcs	Q.C.			
S/N: XXXX	<table border="1" style="margin: auto;"> <tr><td style="text-align: center;">Q C</td></tr> <tr><td style="text-align: center;">XX XX XXXX</td></tr> <tr><td style="text-align: center;">PASSED</td></tr> </table>	Q C	XX XX XXXX	PASSED
Q C				
XX XX XXXX				
PASSED				
CODE: XXX				

LOT NO:



xxxxxxxxxxxxxxxxxxxxxxxxxxxx

RoHS Compliant

## PRECAUTIONS

1. The lead pitch of the LED must match the pitch of the mounting holes on the PCB during component placement. Lead-forming may be required to insure the lead pitch matches the hole pitch. Refer to the figure below for proper lead forming procedures. (Fig. 1)



Fig.1

”○” Correct mounting method ”×” Incorrect mounting method

2. When soldering wire to the LED, use individual heat-shrink tubing to insulate the exposed leads to prevent accidental contact short-circuit. (Fig.2)

3. Use stand-offs (Fig.3) or spacers (Fig.4) to securely position the LED above the PCB.

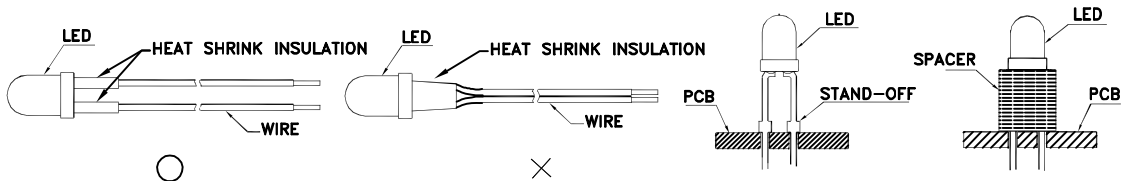

Fig. 2

Fig. 3

Fig. 4

4. Maintain a minimum of 2mm clearance between the base of the LED lens and the first lead bend. (Fig. 5 and 6)
5. During lead forming, use tools or jigs to hold the leads securely so that the bending force will not be transmitted to the LED lens and its internal structures. Do not perform lead forming once the component has been mounted onto the PCB. (Fig. 7)

6. Do not bend the leads more than twice. (Fig. 8)

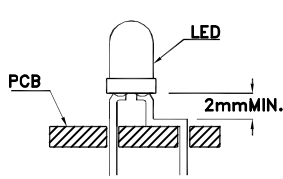

Fig. 5

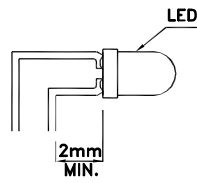

Fig. 6

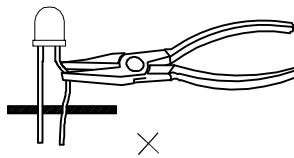

Fig. 7

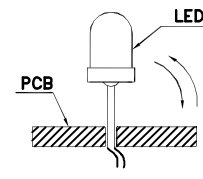
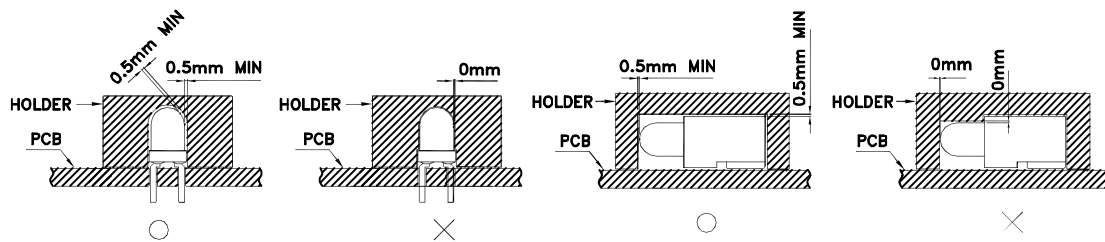

Fig. 8

7. During soldering, component covers and holders should leave clearance to avoid placing damaging stress on the LED during soldering.



8. The tip of the soldering iron should never touch the lens epoxy.

9. Through-hole LEDs are incompatible with reflow soldering.

10. If the LED will undergo multiple soldering passes or face other processes where the part may be subjected to intense heat, please check with Kingbright for compatibility.

11. Recommended Wave Soldering Profile for Kingbright Thru-Hole Products

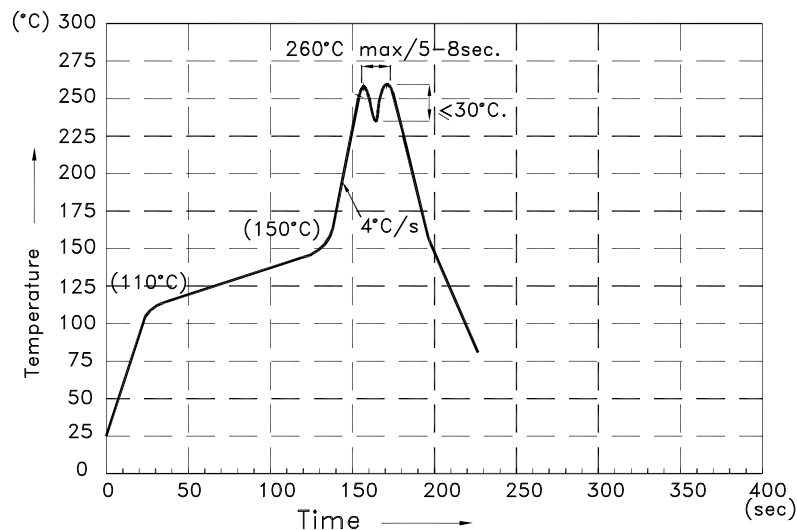

NOTES:

1. Recommend the wave temperature 245°C~260°C. The maximum soldering temperature should be less than 260°C.
2. Do not apply stress on epoxy resins when temperature is over 85°C.
3. The soldering profile apply to the lead free soldering (Sn/Cu/Ag alloy).
4. During wave soldering, the PCB top-surface temperature should be kept below 105°C.
5. No more than once.