



Chipsmall Limited consists of a professional team with an average of over 10 year of expertise in the distribution of electronic components. Based in Hongkong, we have already established firm and mutual-benefit business relationships with customers from,Europe,America and south Asia,supplying obsolete and hard-to-find components to meet their specific needs.

With the principle of “Quality Parts,Customers Priority,Honest Operation,and Considerate Service”,our business mainly focus on the distribution of electronic components. Line cards we deal with include Microchip,ALPS,ROHM,Xilinx,Pulse,ON,Everlight and Freescale. Main products comprise IC,Modules,Potentiometer,IC Socket,Relay,Connector.Our parts cover such applications as commercial,industrial, and automotives areas.

We are looking forward to setting up business relationship with you and hope to provide you with the best service and solution. Let us make a better world for our industry!



Contact us

Tel: +86-755-8981 8866 Fax: +86-755-8427 6832

Email & Skype: info@chipsmall.com Web: www.chipsmall.com

Address: A1208, Overseas Decoration Building, #122 Zhenhua RD., Futian, Shenzhen, China





WPH4003

N-Channel Power MOSFET 1700V, 3A, 10.5Ω, TO-3PF-3L

ON Semiconductor®

<http://onsemi.com>

Features

- ON-resistance $R_{DS(on)} = 8.2\Omega$ (typ.)
- Input Capacitance $C_{iss} = 850\text{pF}$ (typ.)
- 10V drive

Specifications

Absolute Maximum Ratings at $T_a = 25^\circ\text{C}$

Parameter	Symbol	Conditions	Ratings	Unit
Drain-to-Source Voltage	V_{DSS}		1700	V
Gate-to-Source Voltage	V_{GSS}		± 30	V
Drain Current (DC)	I_{Dc}^{*1}	Limited only maximum temperature $T_{ch} = 150^\circ\text{C}$	3	A
	I_{Dpack}^{*2}	$T_c = 25^\circ\text{C}$ (Our ideal heat dissipation condition) *3	2.5	A
Drain Current (Pulse)	I_{DP}	$PW \leq 10\mu\text{s}$, duty cycle $\leq 1\%$	6	A
Allowable Power Dissipation	PD		3.0	W
		$T_c = 25^\circ\text{C}$	55	W
Channel Temperature	T_{ch}		150	$^\circ\text{C}$
Storage Temperature	T_{stg}		-55 to +150	$^\circ\text{C}$
Avalanche Energy (Single Pulse) *4	EAS		49	mJ
Avalanche Current *5	I_{AV}		3	A

Note : *1 Shows chip capability

*2 Package limited

*3 Our condition is radiation from backside.

The method is applying silicone grease to the backside of the device and attaching the device to water-cooled radiator made of aluminium.

*4 $V_{DD} = 50\text{V}$, $L = 10\text{mH}$, $I_{AV} = 3\text{A}$ (Fig.1)

*5 $L \leq 10\text{mH}$, single pulse

Stresses exceeding Maximum Ratings may damage the device. Maximum Ratings are stress ratings only. Functional operation above the Recommended Operating Conditions is not implied. Extended exposure to stresses above the Recommended Operating Conditions may affect device reliability.

Package Dimensions

unit : mm (typ)

7538A-002

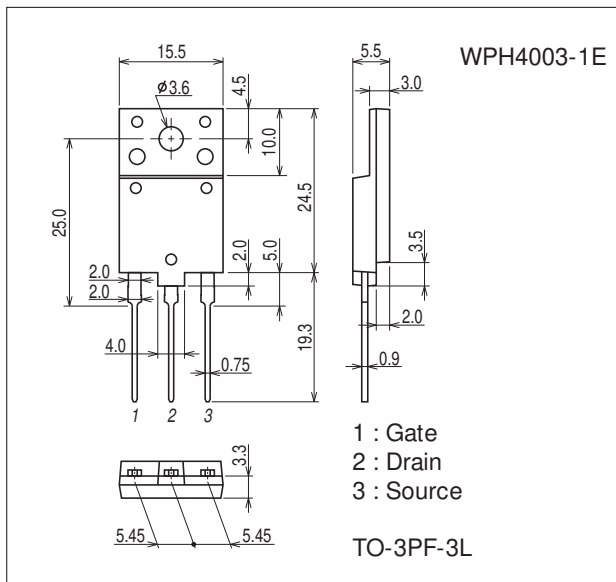

Product & Package Information

- Package : TO-3PF-3L
- JEITA, JEDEC : SC-96
- Minimum Packing Quantity : 30 pcs./magazine

Marking

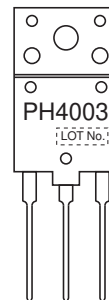

Electrical Connection

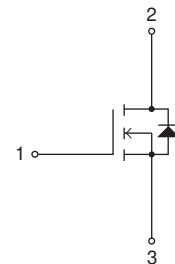

WPH4003

Electrical Characteristics at Ta=25°C

Parameter	Symbol	Conditions	Ratings			Unit	
			min	typ	max		
Drain-to-Source Breakdown Voltage	$V_{(BR)DSS}$	$I_D=10mA, V_{GS}=0V$	1700			V	
Zero-Gate Voltage Drain Current	I_{DSS}	$V_{DS}=1360V, V_{GS}=0V$			1	mA	
Gate-to-Source Leakage Current	I_{GSS}	$V_{GS}=\pm 30V, V_{DS}=0V$			± 100	nA	
Cutoff Voltage	$V_{GS(off)}$	$V_{DS}=10V, I_D=1mA$			4	V	
Forward Transfer Admittance	$ y_{fs} $	$V_{DS}=20V, I_D=1.5A$	1.2	2.4		S	
Static Drain-to-Source On-State Resistance	$R_{DS(on)}$	$I_D=1.5A, V_{GS}=10V$		8.2	10.5	Ω	
Input Capacitance	C_{iss}	$V_{DS}=30V, f=1MHz$		850		pF	
Output Capacitance	C_{oss}				90		pF
Reverse Transfer Capacitance	C_{rss}				27		pF
Turn-ON Delay Time	$t_{d(on)}$	See Fig.2		19		ns	
Rise Time	t_r			21		ns	
Turn-OFF Delay Time	$t_{d(off)}$			200		ns	
Fall Time	t_f			55		ns	
Total Gate Charge	Q_g	$V_{DS}=200V, V_{GS}=10V, I_D=3A$		48		nC	
Gate-to-Source Charge	Q_{gs}			6		nC	
Gate-to-Drain "Miller" Charge	Q_{gd}			22		nC	
Diode Forward Voltage	V_{SD}	$I_S=3A, V_{GS}=0V$		0.8	1.5	V	
Reverse Recovery Time	t_{rr}	See Fig.3		410		ns	
Reverse Recovery Charge	Q_{rr}	$I_S=3A, V_{GS}=0V, di/dt=100A/\mu s$		3000		nC	

Fig.1 Unclamped Inductive Switching Test Circuit

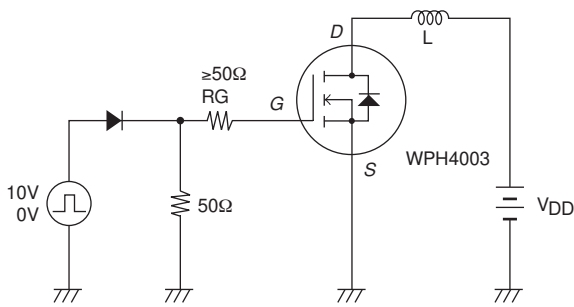

Fig.2 Switching Time Test Circuit

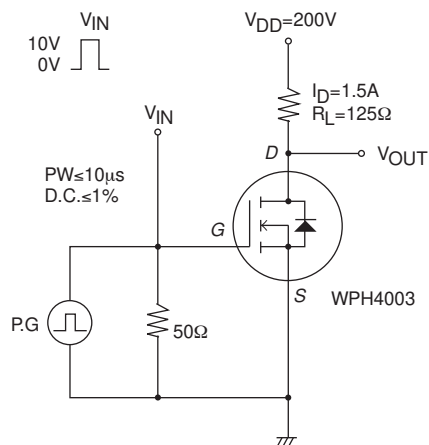
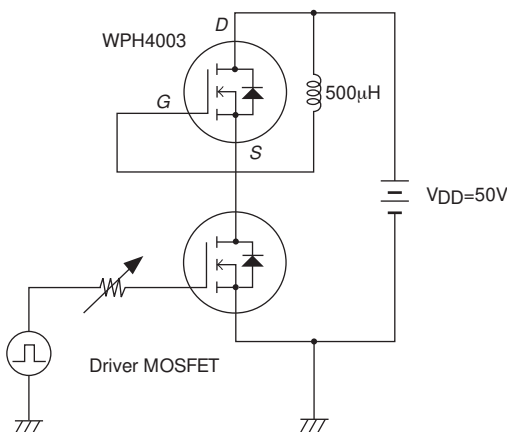
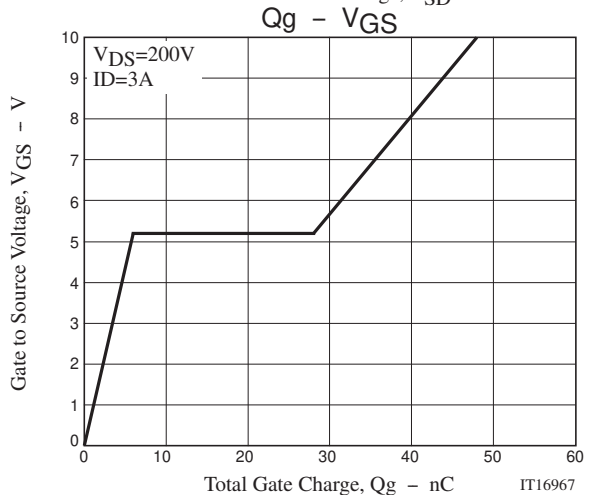
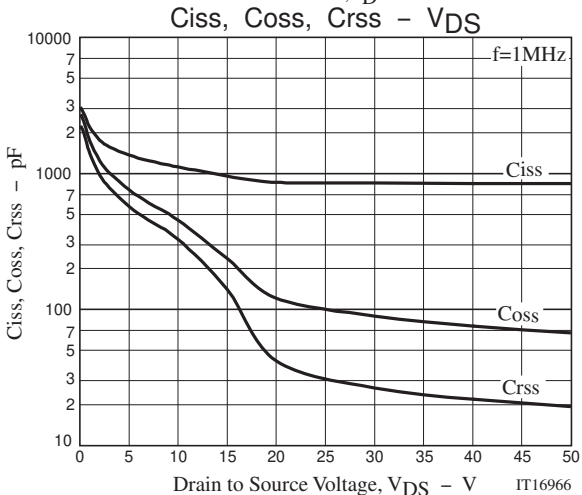
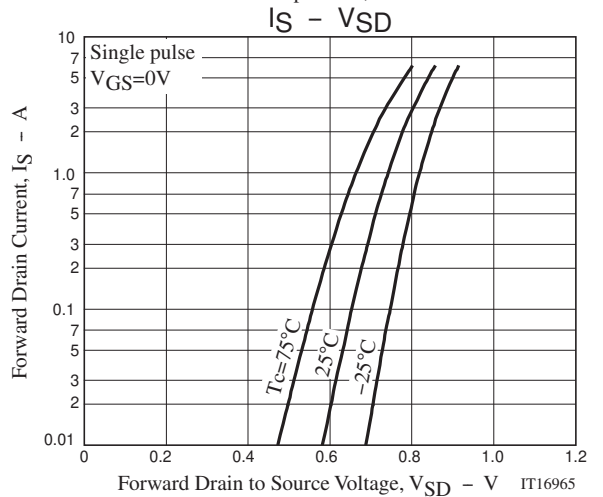
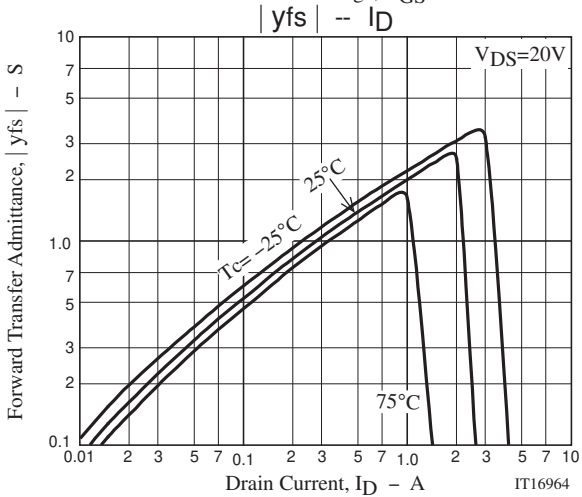
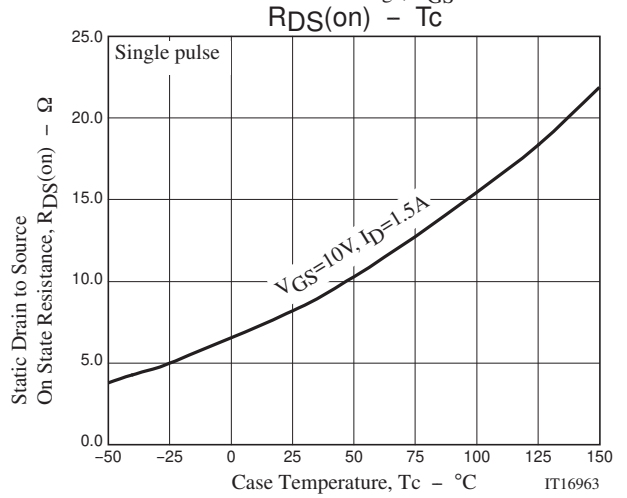
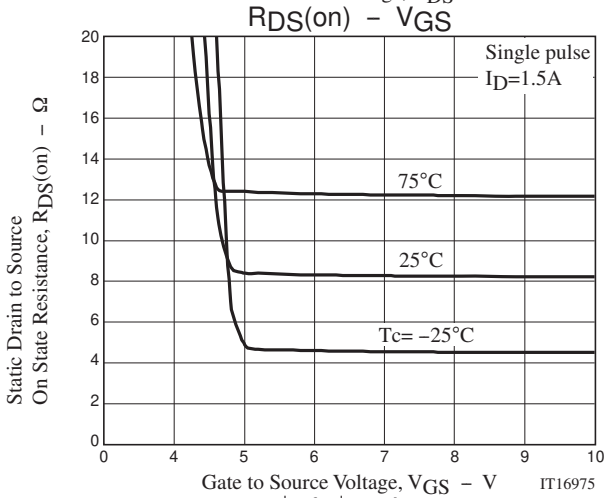
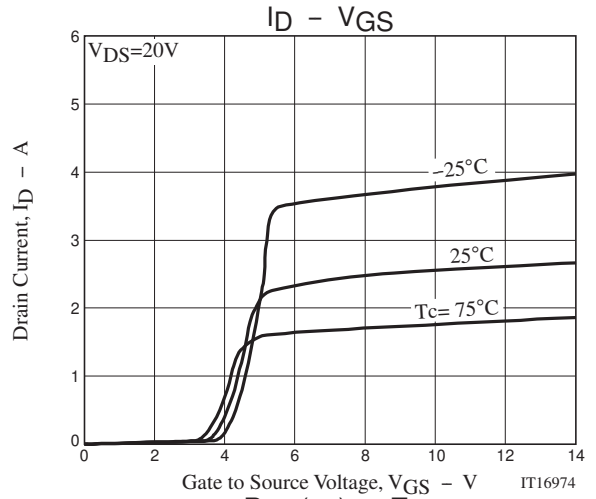
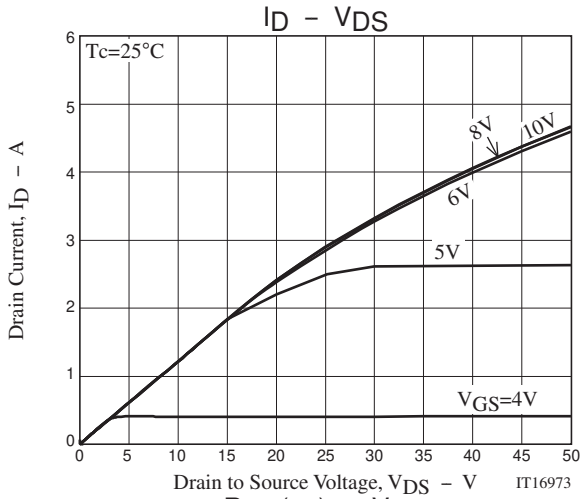

Fig.3 Reverse Recovery Time Test Circuit



Ordering Information

Device	Package	Shipping	memo
WPH4003-1E	TO-3PF-3L	30pcs./magazine	Pb Free



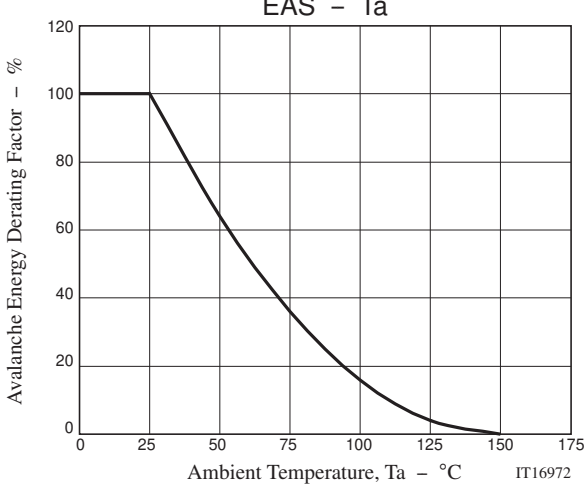
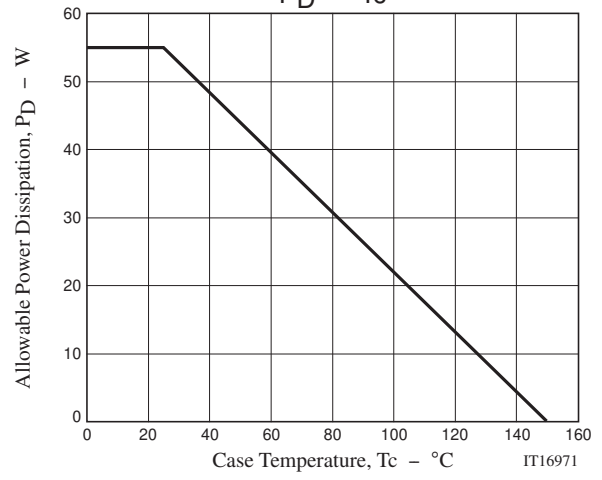
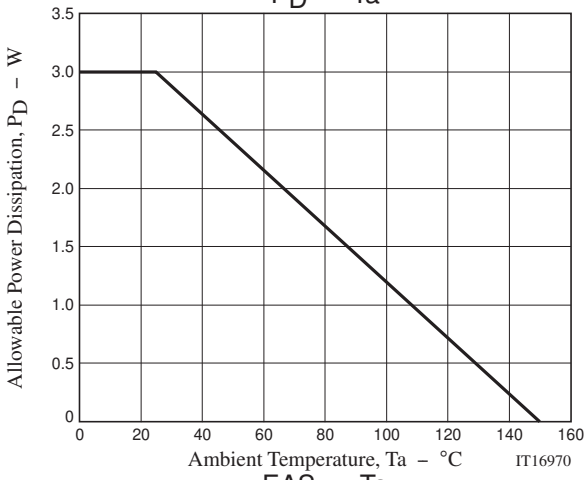
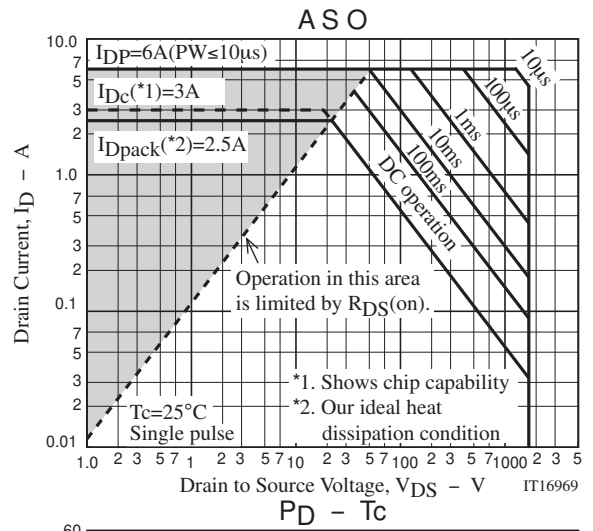
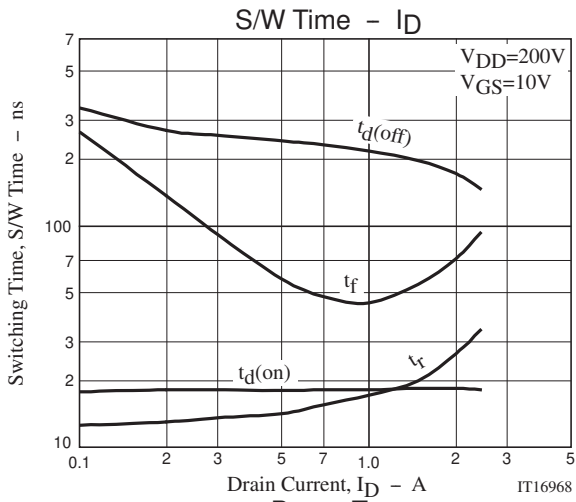

Magazine Specification

WPH4003-1E

1. Packing Format

Package Name	Maximum Number of devices contained (pcs)			Packing format	
	Magazine	Inner box	Outer box	Inner BOX	Outer BOX
TO-3PF-3L	30	360	1440	SPD-0V0001 12 magazines contained Dimensions:mm (external) 568×150×55	SPD-LV0010 4 inner boxes contained Dimensions:mm (external) 590×225×178

2. Magazine dimensions

(unit:mm)

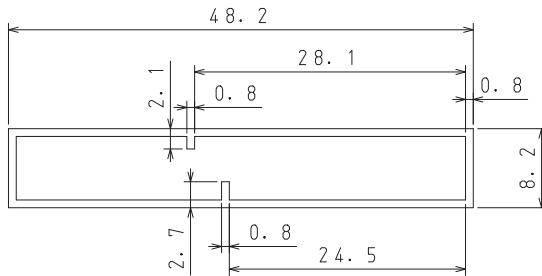

Tolerance=±0.2mm
 Thickness=0.8±0.2mm
 Length =508.0±1mm
 Material =PVC or PET
 (Antistatic treatment)

3. Storage method to magazine

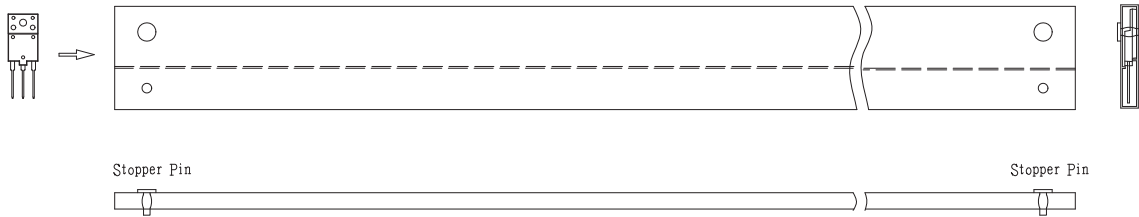

4. Inner box label (unit:mm)

5. Outer box label (unit:mm)

It is a label at the time of factory shipments.
 The form of a label may change in physical distribution process.

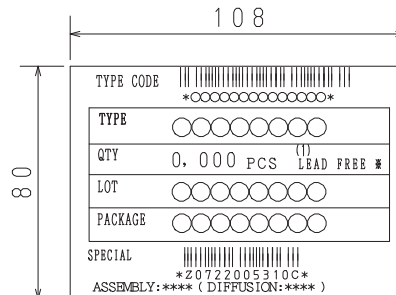
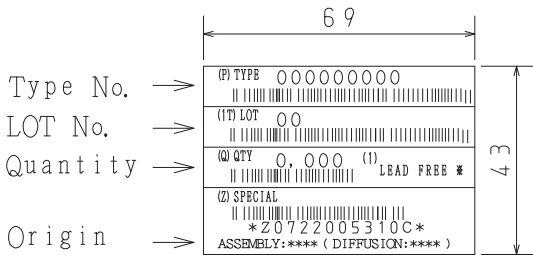

NOTE (1)

The LEAD FREE * description shows that the surface treatment of the terminal is lead free,

Label	JEITA Phase
LEAD FREE 3	JEITA Phase 3A

WPH4003

Outline Drawing

WPH4003-1E

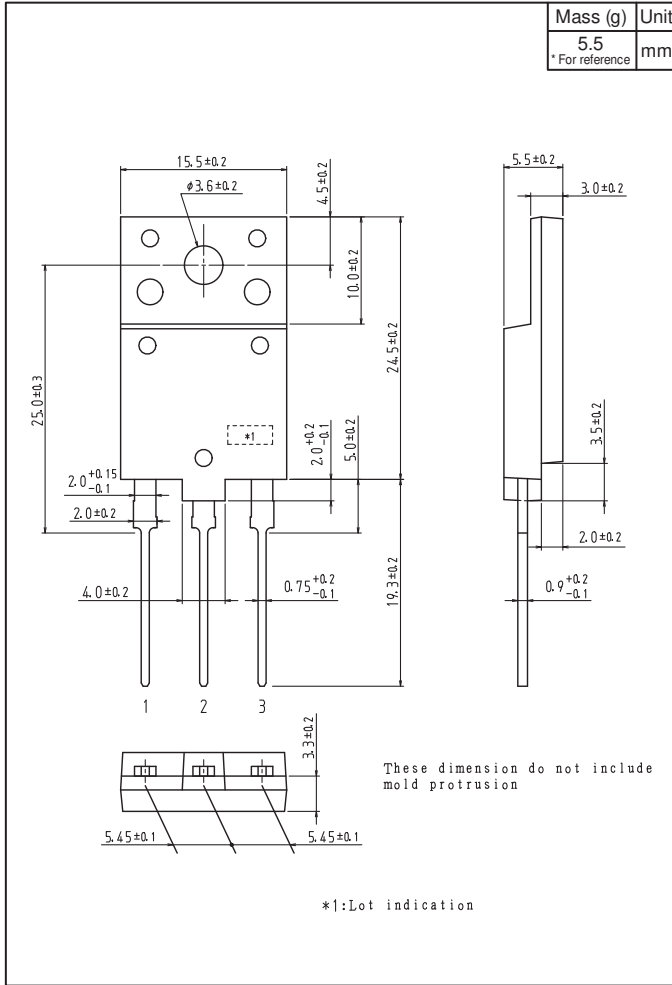

Note on usage : Since the WPH4003 is a MOSFET product, please avoid using this device in the vicinity of highly charged objects.

ON Semiconductor and the ON logo are registered trademarks of Semiconductor Components Industries, LLC (SCILLC). SCILLC owns the rights to a number of patents, trademarks, copyrights, trade secrets, and other intellectual property. A listing of SCILLC's product/patent coverage may be accessed at www.onsemi.com/site/pdf/Patent-Marking.pdf. SCILLC reserves the right to make changes without further notice to any products herein. SCILLC makes no warranty, representation or guarantee regarding the suitability of its products for any particular purpose, nor does SCILLC assume any liability arising out of the application or use of any product or circuit, and specifically disclaims any and all liability, including without limitation special, consequential or incidental damages. "Typical" parameters which may be provided in SCILLC data sheets and/or specifications can and do vary in different applications and actual performance may vary over time. All operating parameters, including "Typicals" must be validated for each customer application by customer's technical experts. SCILLC does not convey any license under its patent rights nor the rights of others. SCILLC products are not designed, intended, or authorized for use as components in systems intended for surgical implant into the body, or other applications intended to support or sustain life, or for any other application in which the failure of the SCILLC product could create a situation where personal injury or death may occur. Should Buyer purchase or use SCILLC products for any such unintended or unauthorized application, Buyer shall indemnify and hold SCILLC and its officers, employees, subsidiaries, affiliates, and distributors harmless against all claims, costs, damages, and expenses, and reasonable attorney fees arising out of, directly or indirectly, any claim of personal injury or death associated with such unintended or unauthorized use, even if such claim alleges that SCILLC was negligent regarding the design or manufacture of the part. SCILLC is an Equal Opportunity/Affirmative Action Employer. This literature is subject to all applicable copyright laws and is not for resale in any manner.