



Chipsmall Limited consists of a professional team with an average of over 10 year of expertise in the distribution of electronic components. Based in Hongkong, we have already established firm and mutual-benefit business relationships with customers from,Europe,America and south Asia,supplying obsolete and hard-to-find components to meet their specific needs.

With the principle of "Quality Parts,Customers Priority,Honest Operation,and Considerate Service",our business mainly focus on the distribution of electronic components. Line cards we deal with include Microchip,ALPS,ROHM,Xilinx,Pulse,ON,Everlight and Freescale. Main products comprise IC,Modules,Potentiometer,IC Socket,Relay,Connector.Our parts cover such applications as commercial,industrial, and automotives areas.

We are looking forward to setting up business relationship with you and hope to provide you with the best service and solution. Let us make a better world for our industry!



Contact us

Tel: +86-755-8981 8866 Fax: +86-755-8427 6832

Email & Skype: info@chipsmall.com Web: www.chipsmall.com

Address: A1208, Overseas Decoration Building, #122 Zhenhua RD., Futian, Shenzhen, China



GlobTek, Inc.
 www.globtek.com
 186 Veterans Drive,
 Northvale, NJ 07647
 Tel. (201) 784-1000
 Fax (201) 784-0111

Drawing Title: GTM43007-C6024-FW, ITE / Medical Power Supply, Efficiency Level: N/A, Case Color/Style: GlobTek Black, Open Frame/Internal, Regulated Switchmode AC-DC Power Supply AC Adaptor, Input Rating: 100-240V~, 50-60 Hz, Molex Header (or equal) , Output Rating: 60W, 24V@2.5A, Output Configuration: N/A mm, N/A/4 Cond, , Molex 4-Pin Header PN: 22-11-2042 MATES W/ PN: 09-50-3041 or Equivalent, Ferrite: None, N/A, GT Cord # C0127, Pin Out: Pins 1 and 2: +V, Pins 3 and 4: -V, Blades/Input Cord: Not Applicable, Approvals: CB ETL CE CB 60601-1 2MOPP CE China RoHS Double Insulation RoHS Ukraine WEEE CE FCC CB CB EN/IEC 60335-1 Level V LPS NEMKO EN/IEC 60335-1 S-Mark IEC/EN 60601-1 WDaE cETLus ES60601 cETLus cETLus 60601-1 3rd

Model No. GTM43007-C6024-FW

Part No./Ordering No. GTM43007-C6024-FW(R)

Rev B

REVISION HISTORY

REV	DESCRIPTION	SUB	DATE	APPROVED
B	Update Ukraine mark, RoHS 2 to RoHS, add EAC	QA	07/16/2018	QA
A	Initial Release	jwarn	05/02/2017	QA

In Addition to GlobTek Inc.'s renewed ISO9001:2008 - Quality Management System Certification, GlobTek Inc. is now certified to:

ISO13485:2003 - Medical Devices Quality Management System Certification
 ISO14001:2004 - Environmental Management System Certification

ISO Certificates are available online at <http://www.globtek.com/iso-certificates/>

Customer Approval of Specification:

Please approve, sign and send back to GlobTek so we can complete order processing.

A delay in receipt of this form will delay delivery schedule.

Company Name:

Customer P/N:

Quote Number:

Date:

Authorized Representative Name:

Authorized Representative Signature:

The acceptance of this specification and use of the product described in this document indicates the acceptance and binding of the customer to Globtek terms and conditions, which supersede all other agreements, terms, and conditions (<http://en.globtek.com/terms-and-conditions/>).

Footnote:

GlobTek Inc. will not be liable for the safety and performance of these power supplies if unauthorized access and repair occurs. End user should consult applicable UL, CSA or EN standards for proper installation instruction.

Limitation of Use:

GlobTek product are not authorized for use as mission critical components in life support hazardous environment, nuclear or aircraft applications without prior written approval from the CEO of GlobTek Inc.

Contents of this document are subject to change without prior notice.

GTM43007-C6024-FW, 60W, 24V@2.5A, Open Frame/Internal, Regulated Switchmode AC-DC Power Supply AC Adaptor

PROPRIETARY INFORMATION

PROPRIETARY OF GLOBTEK, INC. ANY REPRODUCTION, DISCLOSURE OR USE OF THIS DRAWING, IN WHOLE OR IN PART, IS HEREBY PROHIBITED EXCEPT AS SPECIFIED IN WRITING BY GLOBTEK, INC.

GlobTek, Inc.
www.globtek.com
186 Veterans Drive,
Northvale, NJ 07647
Tel. (201) 784-1000
Fax (201) 784-0111

Drawing Title: GTM43007-C6024-FW, ITE / Medical Power Supply, Efficiency Level: N/A, Case Color/Style: GlobTek Black, Open Frame/Internal, Regulated Switchmode AC-DC Power Supply AC Adaptor, Input Rating: 100-240V~, 50-60 Hz, Molex Header (or equal) , Output Rating: 60W, 24V@2.5A, Output Configuration: N/A mm, N/A/4 Cond, , Molex 4-Pin Header PN: 22-11-2042 MATES W/ PN: 09-50-3041 or Equivalent, Ferrite: None, N/A, GT Cord # C0127, Pin Out: Pins 1 and 2: +V, Pins 3 and 4: -V, Blades/Input Cord: Not Applicable, Approvals: CB ETL CE CB 60601-1 2MOPP CE China RoHS Double Insulation RoHS Ukraine WEEE CE FCC CB CB EN/IEC 60335-1 Level V LPS NEMKO EN/IEC 60335-1 S-Mark IEC/EN 60601-1 WDaE cETLus ES60601 cETLus cETLus 60601-1 3rd

Model No. GTM43007-C6024-FW

Part No./Ordering No. GTM43007-C6024-FW(R)

Rev B

POWER SUPPLY INFORMATION

TYPE: Open Frame/Internal
TECHNOLOGY: Regulated Switchmode AC-DC Power Supply AC Adaptor
CASE COLOR: GlobTek Black
NAMEPLATE RATED INPUT: 100-240V~, 50-60 Hz, 1.5A
INPUT CONFIG: Molex Header (or equal)
WATTS: 60.0
VOLTS OUT: 24
CURRENT OUT (Amps): 2.5
BLADE/CORD INCLUDED: N/A:
BLADE/CORD INSTALLED: N/A:
GROUNDING CONFIGURATION (F1) Class II / Double Insulated
EFFICIENCY LEVEL: N/A
OUTPUT CONFIGURATION N/A mm, N/A/4 Cond, , Molex 4-Pin Header PN: 22-11-2042 MATES W/ PN: 09-50-3041 or Equivalent, Ferrite: None,
CONNECTOR PIN OUT: Pins 1 and 2: +V, Pins 3 and 4: -V
LABEL SPECS: Standard GT,L-1186
PACK SPEC:

Notes/Modifications/Customizations (notes in this section supersede the values shown in the standard spec):

DIMENSIONS ARE IN MM UNLESS SPECIFIED OTHERWISE.

GloBtek, Inc. www.globtek.com 186 Veterans Drive, Northvale, NJ 07647 Tel. (201) 784-1000 Fax (201) 784-0111	Drawing Title: GTM43007-C6024-FW, ITE / Medical Power Supply, Efficiency Level: N/A, Case Color/Style: GlobTek Black, Open Frame/Internal, Regulated Switchmode AC-DC Power Supply AC Adaptor, Input Rating: 100-240V~, 50-60 Hz, Molex Header (or equal) , Output Rating: 60W, 24V@2.5A, Output Configuration: N/A mm, N/A/4 Cond, , Molex 4-Pin Header PN: 22-11-2042 MATES W/ PN: 09-50-3041 or Equivalent, Ferrite: None, N/A, GT Cord # C0127, Pin Out: Pins 1 and 2: +V, Pins 3 and 4: -V, Blades/Input Cord: Not Applicable, Approvals: CB ETL CE CB 60601-1 2MOPP CE China RoHS Double Insulation RoHS Ukraine WEEE CE FCC CB CB EN/IEC 60335-1 Level V LPS NEMKO EN/IEC 60335-1 S-Mark IEC/EN 60601-1 WdAE cETLus ES60601 cETLus cETLus 60601-1 3rd	
	Model No. GTM43007-C6024-FW	
	Part No./Ordering No. GTM43007-C6024-FW(R)	Rev B

ELECTRICAL SPECIFICATIONS

A) ELECTRICAL SPECIFICATIONS:

01. Input Voltage: Specified 90-264 Vac, Nameplate rated: 100-240Vac
02. Input Frequency: Specified 47-63 Hz, Nameplate rated 50-60Hz
03. Output Regulation: +/- 3% measured at the output connector
04. Line Voltage Regulation: +/- 0.5% maximum measured at full load
05. Output Ripple (Vp-p): +/- 1% of output voltage, Vp-p, max
06. Turn-ON/OFF: 5% maximum, 1 mS typical recovery time for 25% step load
07. Turn-ON Delay: 1 Sec max
08. Hold-Up Time: 10 mS typical @ nominal input voltage and full load
09. Inrush Current: 30A maximum @ 115 Vac input, 60A maximum @ 230 Vac input
10. Switching Frequency: 65 KHz typical
11. Efficiency: 87% @115Vac, 89% @ 230Vac typical at full load
12. No Load Power: < 300mW @ 230Vac

B) PROTECTION

01. Overvoltage Protection: 110% to 130% of nominal output voltage, and less than 60Vdc
02. Short Circuit/Over-load: momentary short circuit protected, output will auto recover upon removal of short

C) SAFETY

01. Dielectric Withstand Voltage: 4000Vac / 5656Vdc from primary to secondary
02. Earth Leakage Current: Does not exceed 300uA in NORMAL CONDITION and 1000uA in SINGLE FAULT CONDITION
03. Output Leakage Current: Does not exceed 75uA NC(Normal condition) 300uA SFC(single fault condition)
05. Earth continuity test:<0.1 Ohm, Class I Only
06. Mode of operation: Continuous
07. Means of Protection: 2 x MOPP
08. Compliant Standards: See listings at end of this drawing for specifics

D) EMC

- EN 60601-1-2, 4th edition
Emissions, per EN 55032, EN 61000-6-3, EN 61000-6-4
Conducted Emissions: Class B, FCC Part 15, Class B
Radiated Emissions: Class B, FCC Part 15, Class B
Line Frequency Harmonics EN61000-3-2, Class A
Voltage Fluctuations/Flicker EN61000-3-3

- Immunity, per EN 55024, EN 61000-6-1, EN 61000-6-2
Static Discharge Immunity EN61000-4-2, 10kV Contact Discharge, 20kV air discharge
Radiated RF Immunity EN61000-4-3, 10V/m 80-1000MHz, 3V/m 1-2.7GHz, 80% 1KHz AM.
EFT/Burst Immunity EN61000-4-4, 4kV/100kHz.
Line Surge Immunity EN61000-4-5, 2kV differential, 4kV common-mode
Conducted RF Immunity EN61000-4-6, 3Vrms, 80% 1KHz AM
Power Frequency Magnetic Field Immunity EN61000-4-8, 3A/m
Voltage Dip Immunity EN61000-4-11, Criteria

E) OTHER

01. MTBF: 1,000,000 Hours @ 45°C ambient temperature, Full Load
02. Operating Temperature: -10°C to 45°C ambient temperature
03. Humidity: 0% to 95% relative humidity
04. Storage Temperature: -30°C to 80°C
05. Cooling: Convection
06. Elevation: 5000M
07. ROHS 2: Complies with EU 2011/65/EU and China SJ/T 11363-2006

F) MECHANICAL FORMAT

01. Type: Open Frame
02. Size: A suffix version, (2"x3"), 76.2 x 50.8 x 30.5 mm
03. Size: B suffix version, (2"x4"), 101.6 x 50.8 x 30.5 mm
04. Size: C suffix version, (3"x5"), 127.0 x 76.2 x 30.5 mm

PROPRIETARY INFORMATION

PROPRIETARY OF GLOBTEK, INC. ANY REPRODUCTION, DISCLOSURE OR USE OF THIS DRAWING, IN WHOLE OR IN PART, IS HEREBY PROHIBITED EXCEPT AS SPECIFIED IN

WRITING BY GLOBTEK, INC.

quest /08/21/2018 8:08:21 AM

GlobTek, Inc.
 www.globtek.com
 186 Veterans Drive,
 Northvale, NJ 07647
 Tel. (201) 784-1000
 Fax (201) 784-0111

Drawing Title: GTM43007-C6024-FW, ITE / Medical Power Supply, Efficiency Level: N/A, Case Color/Style: GlobTek Black, Open Frame/Internal, Regulated Switchmode AC-DC Power Supply AC Adaptor, Input Rating: 100-240V~, 50-60 Hz, Molex Header (or equal) , Output Rating: 60W, 24V@2.5A, Output Configuration: N/A mm, N/A/4 Cond, , Molex 4-Pin Header PN: 22-11-2042 MATES W/ PN: 09-50-3041 or Equivalent, Ferrite: None, N/A, GT Cord # C0127, Pin Out: Pins 1 and 2: +V, Pins 3 and 4: -V, Blades/Input Cord: Not Applicable, Approvals: CB ETL CE CB 60601-1 2MOPP CE China RoHS Double Insulation RoHS Ukraine WEEE CE FCC CB CB EN/IEC 60335-1 Level V LPS NEMKO EN/IEC 60335-1 S-Mark IEC/EN 60601-1 WDaE cETLus ES60601 cETLus cETLus 60601-1 3rd

Model No. GTM43007-C6024-FW

Part No./Ordering No. GTM43007-C6024-FW(R)

Rev B

G) SPECIAL OPTIONS

- 01. Custom Label Markings
- 02. Short term Output Surge Capability
- 03. Reduced Leakage Current versions
- 04. Tightened output voltage tolerance
- 05. Reduced output ripple level
- 06. High Rel PCB laminate with Plated through Holes for IPC610 Class 2 Compliance
- 07. Low Temperature operation, down to -40°C
- 08. Quasi Constant Current Output, for Lead-Acid Battery Charger Applications
- 09. Special Input or Output Connectors
- 10. Over-Temperature Protection, Latched Shut-Down

Top Diagram is for 5V-14V models, Bottom Diagram is for 15V-48V models

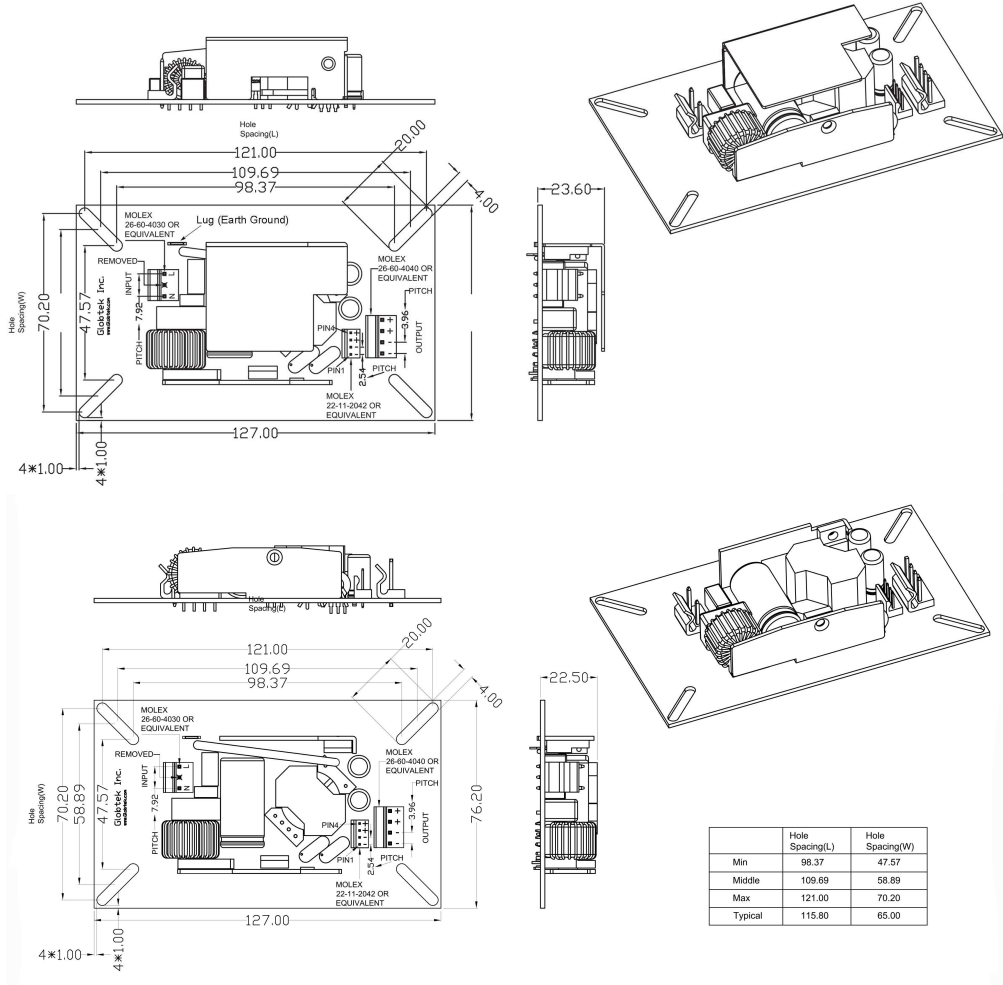

	Hole Spacing(L)	Hole Spacing(W)
Min	98.37	47.57
Middle	109.69	58.89
Max	121.00	70.20
Typical	115.80	65.00

GlobTek, Inc.
 www.globtek.com
 186 Veterans Drive,
 Northvale, NJ 07647
 Tel. (201) 784-1000
 Fax (201) 784-0111

Drawing Title: GTM43007-C6024-FW, ITE / Medical Power Supply, Efficiency Level: N/A, Case Color/Style: GlobTek Black, Open Frame/Internal, Regulated Switchmode AC-DC Power Supply AC Adaptor, Input Rating: 100-240V~, 50-60 Hz, Molex Header (or equal) , Output Rating: 60W, 24V@2.5A, Output Configuration: N/A mm, N/A/4 Cond, , Molex 4-Pin Header PN: 22-11-2042 MATES W/ PN: 09-50-3041 or Equivalent, Ferrite: None, N/A, GT Cord # C0127, Pin Out: Pins 1 and 2: +V, Pins 3 and 4: -V, Blades/Input Cord: Not Applicable, Approvals: CB ETL CE CB 60601-1 2MOPP CE China RoHS Double Insulation RoHS Ukraine WEEE CE FCC CB CB EN/IEC 60335-1 Level V LPS NEMKO EN/IEC 60335-1 S-Mark IEC/EN 60601-1 WDaE cETLus ES60601 cETLus cETLus 60601-1 3rd

Model No. GTM43007-C6024-FW

Part No./Ordering No. GTM43007-C6024-FW(R)

Rev B

DERATING CURVE

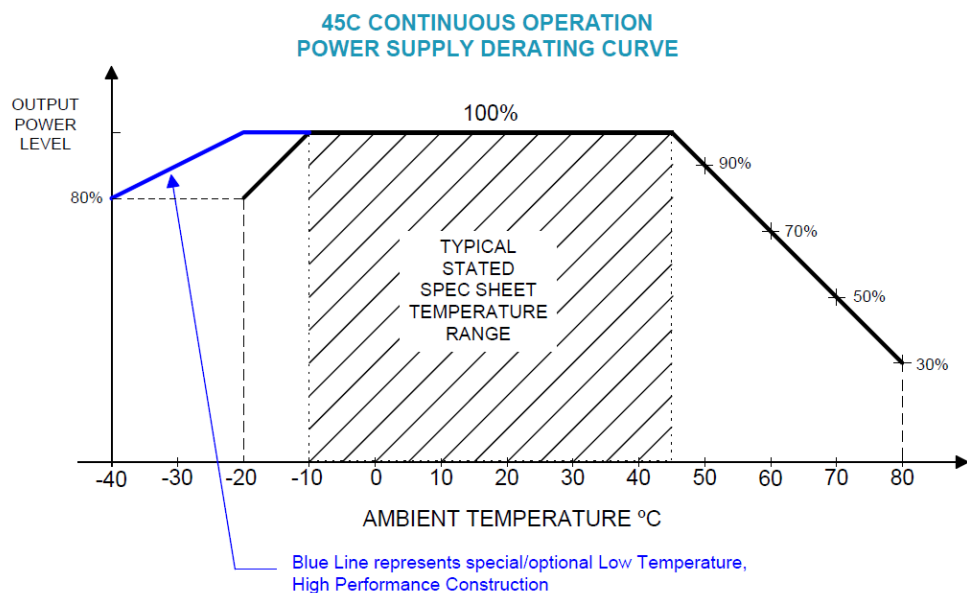

GlobTek, Inc.
 www.globtek.com
 186 Veterans Drive,
 Northvale, NJ 07647
 Tel. (201) 784-1000
 Fax (201) 784-0111

Drawing Title: GTM43007-C6024-FW, ITE / Medical Power Supply, Efficiency Level: N/A, Case Color/Style: GlobTek Black, Open Frame/Internal, Regulated Switchmode AC-DC Power Supply AC Adaptor, Input Rating: 100-240V~, 50-60 Hz, Molex Header (or equal) , Output Rating: 60W, 24V@2.5A, Output Configuration: N/A mm, N/A/4 Cond, , Molex 4-Pin Header PN: 22-11-2042 MATES W/ PN: 09-50-3041 or Equivalent, Ferrite: None, N/A, GT Cord # C0127, Pin Out: Pins 1 and 2: +V, Pins 3 and 4: -V, Blades/Input Cord: Not Applicable, Approvals: CB ETL CE CB 60601-1 2MOPP CE China RoHS Double Insulation RoHS Ukraine WEEE CE FCC CB CB EN/IEC 60335-1 Level V LPS NEMKO EN/IEC 60335-1 S-Mark IEC/EN 60601-1 WDaE cETLus ES60601 cETLus cETLus 60601-1 3rd

Model No. GTM43007-C6024-FW

Part No./Ordering No. GTM43007-C6024-FW(R)

Rev B

INPUT CONFIGURATION

Grounding Configuration:

Blades/Cord Included: N/A:

Blades/Cord Installed: N/A:

Molex 26-60-4030 3 Position Header Pin 1: Line, Pin 2: Removed, PIN 3: Neutral

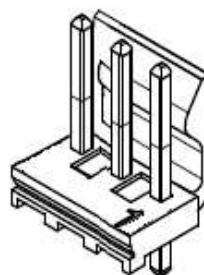
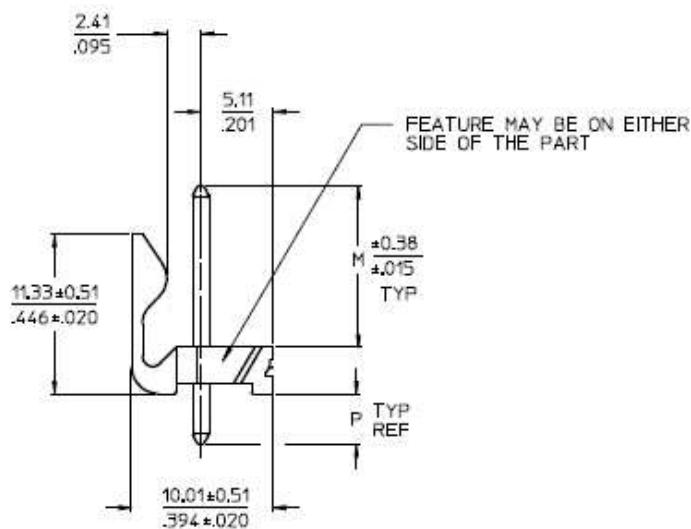

GlobTek, Inc.
 www.globtek.com
 186 Veterans Drive,
 Northvale, NJ 07647
 Tel. (201) 784-1000
 Fax (201) 784-0111

Drawing Title: GTM43007-C6024-FW, ITE / Medical Power Supply, Efficiency Level: N/A, Case Color/Style: GlobTek Black, Open Frame/Internal, Regulated Switchmode AC-DC Power Supply AC Adaptor, Input Rating: 100-240V~, 50-60 Hz, Molex Header (or equal) , Output Rating: 60W, 24V@2.5A, Output Configuration: N/A mm, N/A/4 Cond, , Molex 4-Pin Header PN: 22-11-2042 MATES W/ PN: 09-50-3041 or Equivalent, Ferrite: None, N/A, GT Cord # C0127, Pin Out: Pins 1 and 2: +V, Pins 3 and 4: -V, Blades/Input Cord: Not Applicable, Approvals: CB ETL CE CB 60601-1 2MOPP CE China RoHS Double Insulation RoHS Ukraine WEEE CE FCC CB CB EN/IEC 60335-1 Level V LPS NEMKO EN/IEC 60335-1 S-Mark IEC/EN 60601-1 WDaE cETLus ES60601 cETLus cETLus 60601-1 3rd

Model No. GTM43007-C6024-FW

Part No./Ordering No. GTM43007-C6024-FW(R)

Rev B

OUTPUT CORD AND CONNECTOR: MOLI/C0127

ACTUAL CONNECTORS, OVERMOLDS, FERRITES MAY VARY SLIGHTLY FROM THE PICTURE BELOW

CABLE TYPE

CABLE LENGTH (mm) N/A

CABLE TOLERANCE (mm) N/A

WIRE GAUGE (AWG) N/A

CONDUCTORS 4

HANK DIMENSION (mm) N/A

CABLE / CONNECTOR OVERMOLD COLOR N/A

FERRITE TYPE / DIMENSION None

FERRITE # OF TURNS [\(Definition\)](#) N/A

FERRITE DIMENSION FROM STRAIN RELIEF N/A

FERRITE DIMENSION FROM PLUG N/A

PLUG TYPE Molex 4-Pin Header PN: 22-11-2042 MATES W/ PN: 09-50-3041 or Equivalent

OVER MOLD ORIENTATION

CONNECTOR PIN OUT: Pins 1 and 2: +V, Pins 3 and 4: -V

ADDITIONAL REQUIREMENTS

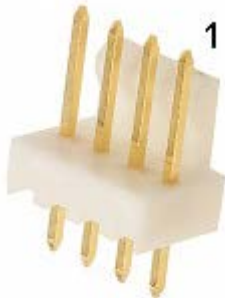

ADDITIONAL OUTPUT PLUG OPTIONS ARE AVAILABLE AT <http://www.globtek.com/connectors/>
 STANDARD PLUGS AND CONNECTORS CAN BE SEEN ONLINE AT <http://www.globtek.com/connectors/>

GlobTek, Inc.
 www.globtek.com
 186 Veterans Drive,
 Northvale, NJ 07647
 Tel. (201) 784-1000
 Fax (201) 784-0111

Drawing Title: GTM43007-C6024-FW, ITE / Medical Power Supply, Efficiency Level: N/A, Case Color/Style: GlobTek Black, Open Frame/Internal, Regulated Switchmode AC-DC Power Supply AC Adaptor, Input Rating: 100-240V~, 50-60 Hz, Molex Header (or equal) , Output Rating: 60W, 24V@2.5A, Output Configuration: N/A mm, N/A/4 Cond, , Molex 4-Pin Header PN: 22-11-2042 MATES W/ PN: 09-50-3041 or Equivalent, Ferrite: None, N/A, GT Cord # C0127, Pin Out: Pins 1 and 2: +V, Pins 3 and 4: -V, Blades/Input Cord: Not Applicable, Approvals: CB ETL CE CB 60601-1 2MOPP CE China RoHS Double Insulation RoHS Ukraine WEEE CE FCC CB CB EN/IEC 60335-1 Level V LPS NEMKO EN/IEC 60335-1 S-Mark IEC/EN 60601-1 WDaE cETLus ES60601 cETLus cETLus 60601-1 3rd

Model No. GTM43007-C6024-FW

Part No./Ordering No. GTM43007-C6024-FW(R)

Rev B

LABEL:L-1186

LABEL P/N: Standard GT
 MATERIAL: Flat Thermal Transfer, Imprintable, Polyester Label and/or Pad Printed and/or Molded, and/or Laser Engraved in the case
 BACKGROUND COLOR: Black if housing is Black, White or Silver if housing is White or Gray.
 TEXT COLOR: White or Silver if label is Black Background for Black housing. Black if label is White or Silver background and Housing is White or Gray
 LABEL WIDTH (mm):
 LABEL HEIGHT (mm):

Below is the minimum information which will appear on the label. NOTE: in the logo area additional/actual positioning of symbols and text is subjected to change as per agency updates/requirements or additional model approvals become available. Regulatory certifications/label markings may be in logo area on the label or molded into the case housing outside the label area. Information will be shown via label and/or pad printed and/or molded and/or laser engraved in the case. * Date code markings at GlobTek option.

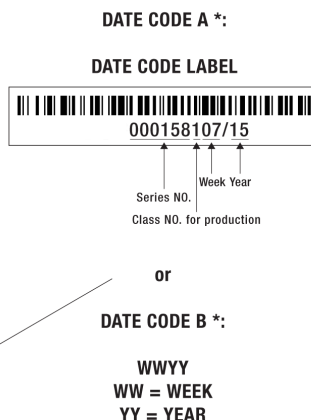

A=ITE / Medical Power Supply
 B=P/N: (料号) GTM43007-C6024-FW(R)
 C=Model (型号) GTM43007-C6024-FW
 D=Input (输入) 100-240V~, 50-60 Hz, 1.5A
 E=Output (输出)24 V 2.5 A ,60.0W

- AGENCY ONLINE DOCUMENTS <http://www.globtek.info/certs/GTM43007/>
- CE EC-Declaration for Medical http://www.globtek.com/pdf/ec_declaration/a00a000000MgcAQEAZ
- CE EC-Declaration for Industrial/Commercial/ITE http://www.globtek.com/pdf/ec_declaration/a00a000000MgcAQEAZ
- RoHS/RoHS2 Declaration http://www.globtek.com/pdf/rohs_cert/01ta0000007dRIWAA2
- REACH Declaration http://www.globtek.com/pdf/iso_certificates/REACH.pdf

GlobTek, Inc.
www.globtek.com
186 Veterans Drive,
Northvale, NJ 07647
Tel. (201) 784-1000
Fax (201) 784-0111

Drawing Title: GTM43007-C6024-FW, ITE / Medical Power Supply, Efficiency Level: N/A, Case Color/Style: GlobTek Black, Open Frame/Internal, Regulated Switchmode AC-DC Power Supply AC Adaptor, Input Rating: 100-240V~, 50-60 Hz, Molex Header (or equal) , Output Rating: 60W, 24V@2.5A, Output Configuration: N/A mm, N/A/4 Cond, , Molex 4-Pin Header PN: 22-11-2042 MATES W/ PN: 09-50-3041 or Equivalent, Ferrite: None, N/A, GT Cord # C0127, Pin Out: Pins 1 and 2: +V, Pins 3 and 4: -V, Blades/Input Cord: Not Applicable, Approvals: CB ETL CE CB 60601-1 2MOPP CE China RoHS Double Insulation RoHS Ukraine WEEE CE FCC CB CB EN/IEC 60335-1 Level V LPS NEMKO EN/IEC 60335-1 S-Mark IEC/EN 60601-1 WDaE cETLus ES60601 cETLus cETLus 60601-1 3rd

Model No. GTM43007-C6024-FW

Part No./Ordering No. GTM43007-C6024-FW(R)

Rev B

Conflict Minerals Declaration

<http://www.globtek.com/pdf/conflict-minerals.pdf>

IPXY rating is based on 3rd party testing and customers should check suitability and test system level IPXY rating before ordering.

Regulatory Certifications/Label Markings

LATEST PRODUCT/MODEL CERTIFICATIONS: <http://en.globtek.com/datasheet/id/a00a000000MgcAQ>

AGENCY ONLINE DOCUMENTS: <http://www.globtek.info/certs/GTM43007/>

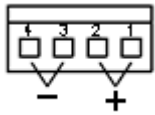

Pins 1 and 2: +V, Pins 3 and 4: -V

GlobTek, Inc.
www.globtek.com
186 Veterans Drive,
Northvale, NJ 07647
Tel. (201) 784-1000
Fax (201) 784-0111

Drawing Title: GTM43007-C6024-FW, ITE / Medical Power Supply, Efficiency Level: N/A, Case Color/Style: GlobTek Black, Open Frame/Internal, Regulated Switchmode AC-DC Power Supply AC Adaptor, Input Rating: 100-240V~, 50-60 Hz, Molex Header (or equal) , Output Rating: 60W, 24V@2.5A, Output Configuration: N/A mm, N/A/4 Cond, , Molex 4-Pin Header PN: 22-11-2042 MATES W/ PN: 09-50-3041 or Equivalent, Ferrite: None, N/A, GT Cord # C0127, Pin Out: Pins 1 and 2: +V, Pins 3 and 4: -V, Blades/Input Cord: Not Applicable, Approvals: CB ETL CE CB 60601-1 2MOPP CE China RoHS Double Insulation RoHS Ukraine WEEE CE FCC CB CB EN/IEC 60335-1 Level V LPS NEMKO EN/IEC 60335-1 S-Mark IEC/EN 60601-1 WDaE cETLus ES60601 cETLus cETLus 60601-1 3rd

Model No. GTM43007-C6024-FW

Part No./Ordering No. GTM43007-C6024-FW(R)

Rev B

PACKAGING

Packing Spec P/N:

Box Qty: 60

Gift Box Size (mm): 147*100*33

Gift Box Color: White

Master Carton
Size (mm): 455*415*210

Master GW (Kg): kg

BLADES INCLUDED: N/A:

BLADE/CORD
INSTALLED: N/A:

GlobTek, Inc.
www.globtek.com
186 Veterans Drive,
Northvale, NJ 07647
Tel. (201) 784-1000
Fax (201) 784-0111

Drawing Title: GTM43007-C6024-FW, ITE / Medical Power Supply, Efficiency Level: N/A, Case Color/Style: GlobTek Black, Open Frame/Internal, Regulated Switchmode AC-DC Power Supply AC Adaptor, Input Rating: 100-240V~, 50-60 Hz, Molex Header (or equal) , Output Rating: 60W, 24V@2.5A, Output Configuration: N/A mm, N/A/4 Cond, , Molex 4-Pin Header PN: 22-11-2042 MATES W/ PN: 09-50-3041 or Equivalent, Ferrite: None, N/A, GT Cord # C0127, Pin Out: Pins 1 and 2: +V, Pins 3 and 4: -V, Blades/Input Cord: Not Applicable, Approvals: CB ETL CE CB 60601-1 2MOPP CE China RoHS Double Insulation RoHS Ukraine WEEE CE FCC CB CB EN/IEC 60335-1 Level V LPS NEMKO EN/IEC 60335-1 S-Mark IEC/EN 60601-1 WDaE cETLus ES60601 cETLus cETLus 60601-1 3rd

Model No. GTM43007-C6024-FW

Part No./Ordering No. GTM43007-C6024-FW(R)

Rev B

INSTRUCTION SHEET

N/A