



Chipsmall Limited consists of a professional team with an average of over 10 year of expertise in the distribution of electronic components. Based in Hongkong, we have already established firm and mutual-benefit business relationships with customers from,Europe,America and south Asia,supplying obsolete and hard-to-find components to meet their specific needs.

With the principle of "Quality Parts,Customers Priority,Honest Operation,and Considerate Service",our business mainly focus on the distribution of electronic components. Line cards we deal with include Microchip,ALPS,ROHM,Xilinx,Pulse,ON,Everlight and Freescale. Main products comprise IC,Modules,Potentiometer,IC Socket,Relay,Connector.Our parts cover such applications as commercial,industrial, and automotives areas.

We are looking forward to setting up business relationship with you and hope to provide you with the best service and solution. Let us make a better world for our industry!



## Contact us

Tel: +86-755-8981 8866 Fax: +86-755-8427 6832

Email & Skype: info@chipsmall.com Web: www.chipsmall.com

Address: A1208, Overseas Decoration Building, #122 Zhenhua RD., Futian, Shenzhen, China



GlobTek, Inc.  
 www.globtek.com  
 186 Veterans Drive,  
 Northvale, NJ 07647  
 Tel. (201) 784-1000  
 Fax (201) 784-0111

Drawing Title: GTM96180-1848, ITE / Medical Power Supply/Class 2/Household Power Supply, Efficiency Level: VI, Case Color/Style: GlobTek Black, Wall Plug-in, Regulated Switchmode AC-DC Power Supply AC Adaptor, Input Rating: 100-240V~, 50-60 Hz, Interchangeable Blades <http://en.globtek.com/interchangeable-blades.php>, Output Rating: 18W, 48V@0.375A, Output Configuration: 1830 mm, 18/1C + Shield Cond, UL 1185, Power & Data ( 2 Jacks), RJ45 jacks mounted in 94V-O polycarbonate non-vented enclosure. Black color with White silkscreen located on top of enclosure. Dimensions 50 X 45 X 28 mm., Ferrite: Core Size: 14.2\*28.5\*8.2, GlobTek Black, GT Cord # C0854, Pin Out: Computer OSU/POWER, Blades/Input Cord: (Order Separately), Approvals: S-Mark IEC/EN 60601-1 IP42 CB CB 230V CoC Tier 2 EAC cETLus cETLus cETLus cETLus 60601-1 3rd FCC ETL UL CCC CE Double Insulation CB cETLus UL1310 China RoHS Level VI CB LPS RoHS Ukraine VCCI WEEE PSE PSE PSE CAN ICES-3 RCM

Model No. GTM96180-1848

Part No./Ordering No. WR9QX375PPOENR6B

Rev D

## REVISION HISTORY

REV	DESCRIPTION	SUB	DATE	APPROVED
D	Change model from GT-46180 to GTM96180-18VV H/M, update approvals on the label	QA	04/11/2018	QA
C	Update Pinout pic on the label	QA	06/17/2016	QA
B	Change O/P cord drawing	QA	06/07/2016	QA
A	Intial release.	emcna	04/06/2016	QA

In Addition to GlobTek Inc.'s renewed ISO9001:2008 - Quality Management System Certification, GlobTek Inc. is now certified to:

ISO13485:2003 - Medical Devices Quality Management System Certification

ISO14001:2004 - Environmental Management System Certification

ISO Certificates are available online at <http://www.globtek.com/iso-certificates/>

### Customer Approval of Specification:

Please approve, sign and send back to GlobTek so we can complete order processing.

A delay in receipt of this form will delay delivery schedule.

Company Name:

Customer P/N:

Quote Number:

Date:

Authorized Representative Name:

Authorized Representative Signature:

The acceptance of this specification and use of the product described in this document indicates the acceptance and binding of the customer to Globtek terms and conditions, which supersede all other agreements, terms, and conditions (<http://en.globtek.com/terms-and-conditions/>).

### Footnote:

GlobTek Inc. will not be liable for the safety and performance of these power supplies if unauthorized access and repair occurs. End user should consult applicable UL, CSA or EN standards for proper installation instruction.

### Limitation of Use:

GlobTek product are not authorized for use as mission critical components in life support hazardous environment, nuclear or aircraft applications without prior written approval from the CEO of GlobTek Inc.

Contents of this document are subject to change without prior notice.

GTM96180-1848, 18W, 48V@0.375A, Wall Plug-in, Regulated Switchmode AC-DC Power Supply AC Adaptor

PROPRIETARY INFORMATION

PROPRIETARY OF GLOBTEK, INC. ANY REPRODUCTION, DISCLOSURE OR USE OF THIS DRAWING, IN WHOLE OR IN PART, IS HEREBY PROHIBITED EXCEPT AS SPECIFIED IN WRITING BY GLOBTEK, INC.

GlobTek, Inc.  
www.globtek.com  
186 Veterans Drive,  
Northvale, NJ 07647  
Tel. (201) 784-1000  
Fax (201) 784-0111

Drawing Title: GTM96180-1848, ITE / Medical Power Supply/Class 2/Household Power Supply, Efficiency Level: VI, Case Color/Style: GlobTek Black, Wall Plug-in, Regulated Switchmode AC-DC Power Supply AC Adaptor, Input Rating: 100-240V~, 50-60 Hz, Interchangeable Blades <http://en.globtek.com/interchangeable-blades.php>, Output Rating: 18W, 48V@0.375A, Output Configuration: 1830 mm, 18/1C + Shield Cond, UL 1185, Power & Data ( 2 Jacks), RJ45 jacks mounted in 94V-O polycarbonate non-vented enclosure. Black color with White silkscreen located on top of enclosure. Dimensions 50 X 45 X 28 mm., Ferrite: Core Size: 14.2\*28.5\*8.2, GlobTek Black, GT Cord # C0854, Pin Out: Computer OSU/POWER, Blades/Input Cord: (Order Separately), Approvals: S-Mark IEC/EN 60601-1 IP42 CB CB 230V CoC Tier 2 EAC cETLus cETLus cETLus cETLus 60601-1 3rd FCC ETL UL CCC CE Double Insulation CB cETLus UL1310 China RoHS Level VI CB LPS RoHS Ukraine VCCI WEEE PSE PSE PSE CAN ICES-3 RCM

Model No. GTM96180-1848

Part No./Ordering No. WR9QX375PPOENR6B

Rev D

## POWER SUPPLY INFORMATION

TYPE: Wall Plug-in  
TECHNOLOGY: Regulated Switchmode AC-DC Power Supply AC Adaptor  
CASE COLOR: GlobTek Black  
NAMEPLATE RATED INPUT: 100-240V~, 50-60 Hz, 0.6 A  
INPUT CONFIG: Interchangeable Blades  
WATTS: 18.0  
VOLTS OUT: 48  
CURRENT OUT (Amps): 0.375  
BLADE/CORD INCLUDED: None:  
BLADE/CORD INSTALLED: None:  
GROUNDING CONFIGURATION  
EFFICIENCY LEVEL: VI  
OUTPUT CONFIGURATION: 1830 mm, 18/1C + Shield Cond, UL 1185, Power & Data ( 2 Jacks), RJ45 jacks mounted in 94V-O polycarbonate non-vented enclosure. Black color with White silkscreen located on top of enclosure. Dimensions 50 X 45 X 28 mm., Ferrite: Core Size: 14.2\*28.5\*8.2, GlobTek Black, GT Cord # C0854  
CONNECTOR PIN OUT: Computer OSU/POWER  
LABEL SPECS: Standard GT,L-1186  
PACK SPEC: Cellular packaging

Notes/Modifications/Customizations (notes in this section supersede the values shown in the standard spec):

DIMENSIONS ARE IN MM UNLESS SPECIFIED OTHERWISE.

GlobTek, Inc.  
www.globtek.com  
186 Veterans Drive,  
Northvale, NJ 07647  
Tel. (201) 784-1000  
Fax (201) 784-0111

Drawing Title: GTM96180-1848, ITE / Medical Power Supply/Class 2/Household Power Supply, Efficiency Level: VI, Case Color/Style: GlobTek Black, Wall Plug-in, Regulated Switchmode AC-DC Power Supply AC Adaptor, Input Rating: 100-240V~, 50-60 Hz, Interchangeable Blades <http://en.globtek.com/interchangeable-blades.php>, Output Rating: 18W, 48V@0.375A, Output Configuration: 1830 mm, 18/1C + Shield Cond, UL 1185, Power & Data ( 2 Jacks), RJ45 jacks mounted in 94V-O polycarbonate non-vented enclosure. Black color with White sillkscreen located on top of enclosure. Dimensions 50 X 45 X 28 mm., Ferrite: Core Size: 14.2\*28.5\*8.2, GlobTek Black, GT Cord # C0854, Pin Out: Computer OSU/POWER, Blades/Input Cord: (Order Separately), Approvals: S-Mark IEC/EN 60601-1 IP42 CB CB 230V CoC Tier 2 EAC cETLus cETLus cETLus cETLus 60601-1 3rd FCC ETL UL CCC CE Double Insulation CB cETLus UL1310 China RoHS Level VI CB LPS RoHS Ukraine VCCI WEEE PSE PSE PSE CAN ICES-3 RCM

Model No. GTM96180-1848

Part No./Ordering No. WR9QX375PPOENR6B

Rev D

## ELECTRICAL SPECIFICATIONS

### A) ELECTRICAL SPECIFICATIONS:

01. Input Voltage: Specified 90-264 Vac, Nameplate rated: 100-240Vac  
90-264 Vac range @ 100% of rated load current  
85-264 Vac range @ 85% of rated load current  
110-370 VDC range @ 100% of rated load current
02. Input Frequency: Specified 47-63 Hz, Nameplate rated 50-60Hz
03. Output Regulation: +/- 5% measured at the output connector
04. Line Voltage Regulation: +/- 0.5% typical measured at full load
05. Green Power On Indicator LED
06. Output Ripple (Vp-p): 1% or 100 mV whichever is greater, measured at 20 MHz bandwidth with 0.1 uf ceramic capacitor in parallel with a low impedance 47 uf electrolytic capacitor connected at the end of the output connector
07. Turn-ON/OFF Overshoot: 5% maximum, 1 mS typical recovery time for 40% to 70% step load
08. Turn-ON Delay: 1 second maximum @ full load, nominal line
09. Hold-Up Time: 8 mS typical @ nominal input voltage and full load
10. Inrush Current: 30A/60A maximum cold start @ 115/230Vac input
11. Efficiency: Compliant with Efficiency Level VI and CoC Tier 2 standards
12. No Load Standby Power: <0.075 W @ 230Vac

### B) PROTECTION

01. Input Protection: Input line fusing and 300Vac MOV
02. Short Circuit/ Overload: Electronically Protected unit will auto recover upon removal of fault  
Output Current Limit: 110% to 160% of rated output current  
(upper end of current limit range is determined by normal output power rating, not derated output power level)
03. Output Over-Voltage: 110% to 130% of nominal output voltage

### C) SAFETY

01. Dielectric Withstand Voltage: 4000Vac or 5656Vdc from input to output, On Class I models, 3000Vac or 4242Vdc from input to earth
02. Earth Leakage Current: Class I models < 300uA, N/A for Class II models
03. Touch Current: Class I models < 20uA, Class II models < 75uA
04. Output Floating or Earthed option for Class I desktop models.  
See [Output Isolation Options](#) for details
05. Earth Continuity Test: < 0.1 Ohm between Earth Pin at AC input and PCB termination point (Class I models only)
06. Means of Protection: 2 x MOPP
07. Compliant Standards: See listings at end of this drawing for specifics

### D) EMC

EN 60601-1-2, 4<sup>th</sup> edition  
Emissions, per EN 55032, EN 61000-6-3, EN 61000-6-4  
Conducted Emissions: Class B, FCC Part 15, Class B  
Radiated Emissions: Class B, FCC Part 15, Class B  
Line Frequency Harmonics EN61000-3-2, Class A  
Voltage Fluctuations/Flicker EN61000-3-3

Immunity, per EN 55024, EN 61000-6-1, EN 61000-6-2  
Static Discharge Immunity EN61000-4-2, 10kV Contact Discharge, 20kV air discharge  
Radiated RF Immunity EN61000-4-3, 10V/m 80-1000MHz, 3V/m 1-2.7GHz, 80% 1KHz AM.  
EFT/Burst Immunity EN61000-4-4, 4kV/100kHz.  
Line Surge Immunity EN61000-4-5, 2kV differential, 4kV common-mode  
Conducted RF Immunity EN61000-4-6, 3Vrms, 80% 1KHz AM  
Power Frequency Magnetic Field Immunity EN61000-4-8, 3A/m  
Voltage Dip Immunity EN61000-4-11, Criteria

### E) OTHER:

01. MTBF: 1,000,000 Hours @ 40°C ambient temperature, Full Load
02. Operating Temperature: -20°C to 40°C ambient temperature at full load, -40°C to 50°C ambient temperature with derating to 80% load
03. Operating Humidity: 0% to 95% relative humidity, non-condensing
04. Storage Temperature: -30°C to 80°C
05. Operating Altitude: 5000 Meters

#### PROPRIETARY INFORMATION

PROPRIETARY OF GLOBTEK, INC. ANY REPRODUCTION, DISCLOSURE OR USE OF THIS DRAWING, IN WHOLE OR IN PART, IS HEREBY PROHIBITED EXCEPT AS SPECIFIED IN WRITING BY GLOBTEK, INC.

GlobTek, Inc.  
 www.globtek.com  
 186 Veterans Drive,  
 Northvale, NJ 07647  
 Tel. (201) 784-1000  
 Fax (201) 784-0111

Drawing Title: GTM96180-1848, ITE / Medical Power Supply/Class 2/Household Power Supply, Efficiency Level: VI, Case Color/Style: GlobTek Black, Wall Plug-in, Regulated Switchmode AC-DC Power Supply AC Adaptor, Input Rating: 100-240V~, 50-60 Hz, Interchangeable Blades <http://en.globtek.com/interchangeable-blades.php>, Output Rating: 18W, 48V@0.375A, Output Configuration: 1830 mm, 18/1C + Shield Cond, UL 1185, Power & Data ( 2 Jacks), RJ45 jacks mounted in 94V-O polycarbonate non-vented enclosure. Black color with White sillkscreen located on top of enclosure. Dimensions 50 X 45 X 28 mm., Ferrite: Core Size: 14.2\*28.5\*8.2, GlobTek Black, GT Cord # C0854, Pin Out: Computer OSU/POWER, Blades/Input Cord: (Order Separately), Approvals: S-Mark IEC/EN 60601-1 IP42 CB CB 230V CoC Tier 2 EAC cETLus cETLus cETLus cETLus 60601-1 3rd FCC ETL UL CCC CE Double Insulation CB cETLus UL1310 China RoHS Level VI CB LPS RoHS Ukraine VCCI WEEE PSE PSE PSE CAN ICES-3 RCM

Model No. GTM96180-1848

Part No./Ordering No. WR9QX375PPOENR6B

Rev D

06. Ingress Protection: IP40 standard, IP52 available as special option  
 07. ROHS: Compliant with latest regulations, see approvals section below

F) ENCLOSURE

- 01. Housing: High impact plastic, 94V0 polycarbonate, non-vented
- 02. Markings: Label or Laser Printed
- 03. AC Input mechanical options: Class II Wall Plug-in, Changeable Blades Desktop Option, extended housing: C6, C8, C14 or C18 IEC Inlet.

G) SPECIAL OPTIONS

- 01. Cost reduction, removal of LED
  - 02. Custom Cordsets, various cordage types, and connector types\*
  - 03. Custom Markings
  - 04. Short term Output Surge Capability
  - 05. Reduced Leakage Current versions (10uA max), for CF medical applications, and AC noise sensitive equipment, 15W or less, 5V to 24V output voltage range.
  - 06. Tightened output voltage tolerance
  - 07. Reduced output ripple level
  - 08. Reduced output power rating marking
  - 09. High Rel PCB laminate with Plated through Holes for IPC610 Class 2 Compliance
  - 10. Special Housing Colors and Cordset Colors
  - 11. Quasi Constant Current Output, for Lead-Acid Battery Charger Applications
- \* 5Vdc USB output connector power supplies, which use the Micro-B or C-type style connector, have a max output voltage regulation specification of +/-8% (4.6V to 5.4V range).

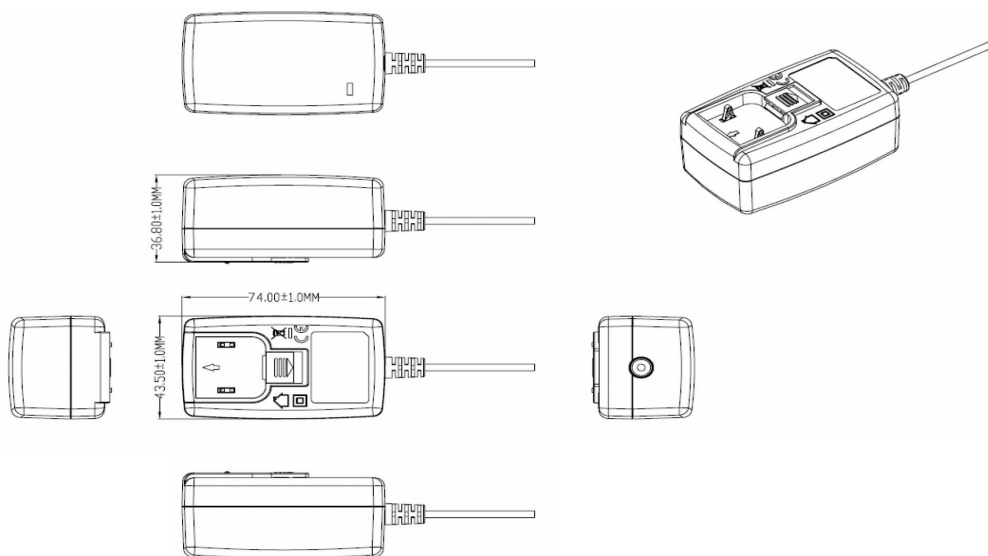

**LED INDICATOR:** Green Power ON indicator LED standard. May be ordered without LED as an option, for cost reduction.

GlobTek, Inc.  
 www.globtek.com  
 186 Veterans Drive,  
 Northvale, NJ 07647  
 Tel. (201) 784-1000  
 Fax (201) 784-0111

Drawing Title: GTM96180-1848, ITE / Medical Power Supply/Class 2/Household Power Supply, Efficiency Level: VI, Case Color/Style: GlobTek Black, Wall Plug-in, Regulated Switchmode AC-DC Power Supply AC Adaptor, Input Rating: 100-240V~, 50-60 Hz, Interchangeable Blades <http://en.globtek.com/interchangeable-blades.php>, Output Rating: 18W, 48V@0.375A, Output Configuration: 1830 mm, 18/1C + Shield Cond, UL 1185, Power & Data ( 2 Jacks), RJ45 jacks mounted in 94V-O polycarbonate non-vented enclosure. Black color with White sillkscreen located on top of enclosure. Dimensions 50 X 45 X 28 mm., Ferrite: Core Size: 14.2\*28.5\*8.2, GlobTek Black, GT Cord # C0854, Pin Out: Computer OSU/POWER, Blades/Input Cord: (Order Separately), Approvals: S-Mark IEC/EN 60601-1 IP42 CB CB 230V CoC Tier 2 EAC cETLus cETLus cETLus cETLus 60601-1 3rd FCC ETL UL CCC CE Double Insulation CB cETLus UL1310 China RoHS Level VI CB LPS RoHS Ukraine VCCI WEEE PSE PSE PSE CAN ICES-3 RCM

Model No. GTM96180-1848

Part No./Ordering No. WR9QX375PPOENR6B

Rev D

DERATING CURVE

**TYPICAL EXTERNAL POWER SUPPLY  
 DERATING CURVE**  
 (FOR 18W AND 36W EFFICIENCY LEVEL VI PRODUCTS)

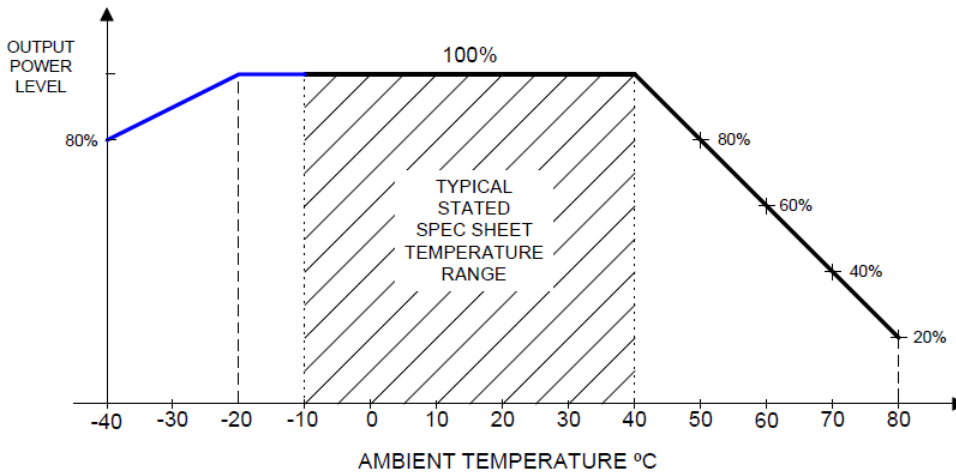

GlobTek, Inc.  
www.globtek.com  
186 Veterans Drive,  
Northvale, NJ 07647  
Tel. (201) 784-1000  
Fax (201) 784-0111

Drawing Title: GTM96180-1848, ITE / Medical Power Supply/Class 2/Household Power Supply, Efficiency Level: VI, Case Color/Style: GlobTek Black, Wall Plug-in, Regulated Switchmode AC-DC Power Supply AC Adaptor, Input Rating: 100-240V~, 50-60 Hz, Interchangeable Blades <http://en.globtek.com/interchangeable-blades.php>, Output Rating: 18W, 48V@0.375A, Output Configuration: 1830 mm, 18/1C + Shield Cond, UL 1185, Power & Data ( 2 Jacks), RJ45 jacks mounted in 94V-O polycarbonate non-vented enclosure. Black color with White sillkscreen located on top of enclosure. Dimensions 50 X 45 X 28 mm., Ferrite: Core Size: 14.2\*28.5\*8.2, GlobTek Black, GT Cord # C0854, Pin Out: Computer OSU/POWER, Blades/Input Cord: (Order Separately), Approvals: S-Mark IEC/EN 60601-1 IP42 CB CB 230V CoC Tier 2 EAC cETLus cETLus cETLus cETLus 60601-1 3rd FCC ETL UL CCC CE Double Insulation CB cETLus UL1310 China RoHS Level VI CB LPS RoHS Ukraine VCCI WEEE PSE PSE PSE CAN ICES-3 RCM

Model No. GTM96180-1848

Part No./Ordering No. WR9QX375PPOENR6B

Rev D

## INPUT CONFIGURATION

Blades/Cord Included: None:

Blades/Cord Installed: None:

Blade Options for Q Series Wall Plug-in Power Supplies

Data Sheet: <http://en.globtek.com/interchangeable-blades.php>

Insertion Instructions: <http://www.globtek.com/pdf/Instructions-Interchangeable-Blades.pdf>

Video: [Q-Blade Style Instruction Video](#)

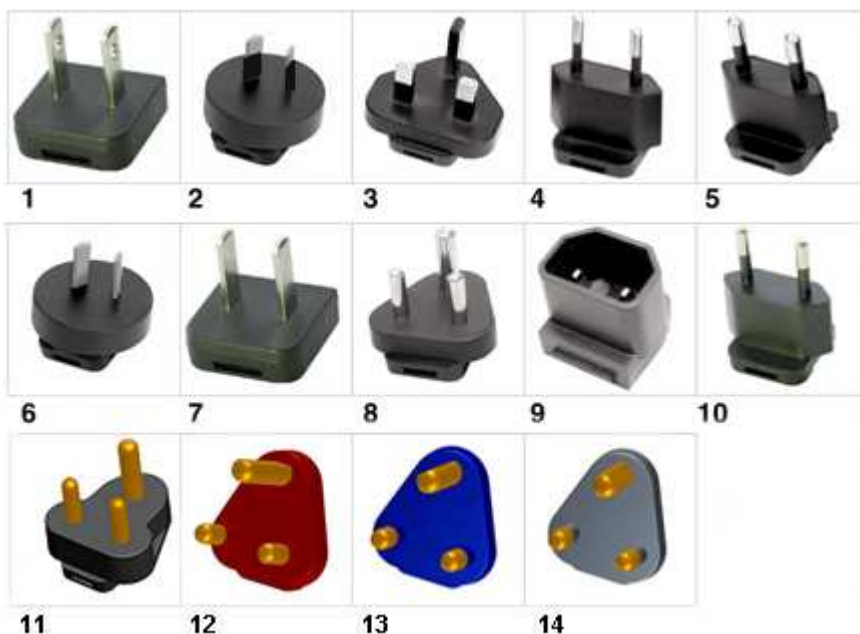

INPUT CONNECTOR: Q-Socket (below are available blades configurations which are "not included" (unless stated above); can be purchased separately, package with power supply or as a separate "Q-KIT" if specified

01. United States / Canada / Japan NEMA 1-15P configuration: NA 2 blades, Class II; US/CA/JP P/N: Q-NA(R)
02. Australian AS 3112 configuration: SAA 2 blade, Class II; AU P/N: Q-SAA(R)
03. UK BS 1363 configuration: UK 3 blade with dummy Ground, Class II; GB P/N: Q-UK(R)
04. European CEE 7/16 configuration: Europlug 2 pins, Class II; EU P/N: Q-EU(R)
05. Korean KS C8305 configuration: 2 pins, Class II; KR P/N: Q-KR(R)
06. Argentina IRAM 2073 configuration: 2 blades; AR P/N: Class II Q-AR(R)
07. China GB 2099 configuration: 2 blades, Class II; CN P/N: Q-CN(R)
08. India IS 1293 6A/BS546 configuration: 5A, 3 pins with Dummy Ground, Class II; IN P/N: Q-IN(R)
09. IEC320/C18 Inlet, Class II; P/N: Q-C18(R)
10. Brazilian NBR6147 configuration: 2 pins, Class II; BR P/N: Q-BR(R)
11. South Africa SABS164-1, 3 round prongs, Class II + dummy ground, P/N: Q-SANS164-1-16A(R)
12. South Africa SABS164-4, 3 round prongs with a notched prong @ 0°, Class II + dummy ground, Red, P/N: Q-SANS164-4L-16A(R)
13. South Africa SABS164-4, 3 round prongs with a notched prong @ -53°, Class II + dummy ground, Blue, P/N:

PROPRIETARY INFORMATION

PROPRIETARY OF GLOBTEK, INC. ANY REPRODUCTION, DISCLOSURE OR USE OF THIS DRAWING, IN WHOLE OR IN PART, IS HEREBY PROHIBITED EXCEPT AS SPECIFIED IN WRITING BY GLOBTEK, INC.

GlobTek, Inc.  
www.globtek.com  
186 Veterans Drive,  
Northvale, NJ 07647  
Tel. (201) 784-1000  
Fax (201) 784-0111

Drawing Title: GTM96180-1848, ITE / Medical Power Supply/Class 2/Household Power Supply, Efficiency Level: VI, Case Color/Style: GlobTek Black, Wall Plug-in, Regulated Switchmode AC-DC Power Supply AC Adaptor, Input Rating: 100-240V~, 50-60 Hz, Interchangeable Blades <http://en.globtek.com/interchangeable-blades.php>, Output Rating: 18W, 48V@0.375A, Output Configuration: 1830 mm, 18/1C + Shield Cond, UL 1185, Power & Data ( 2 Jacks), RJ45 jacks mounted in 94V-O polycarbonate non-vented enclosure. Black color with White sillkscreen located on top of enclosure. Dimensions 50 X 45 X 28 mm., Ferrite: Core Size: 14.2\*28.5\*8.2, GlobTek Black, GT Cord # C0854, Pin Out: Computer OSU/POWER, Blades/Input Cord: (Order Separately), Approvals: S-Mark IEC/EN 60601-1 IP42 CB CB 230V CoC Tier 2 EAC cETLus cETLus cETLus cETLus 60601-1 3rd FCC ETL UL CCC CE Double Insulation CB cETLus UL1310 China RoHS Level VI CB LPS RoHS Ukraine VCCI WEEE PSE PSE PSE CAN ICES-3 RCM

Model No. GTM96180-1848

Part No./Ordering No. WR9QX375PPOENR6B

Rev D

Q-SANS164-4C-16A(R)

14. South Africa SABS164-4, 3 round prongs with a notched prong @ +53°, Class II + dummy ground, Black, P/N:

Q-SANS164-4R-16A(R)

#### Kits

- 01. Q-KIT: 1,2,3,4 above
- 02. Q-KIT-INTL: 2,3,4 above
- 03. Q-KIT-6: 1,2,3,4,5,6 above
- 04. Q-KIT-7: 1,2,3,4,5,6,7 above
- 05. Q-KIT-8: 1,2,3,4,5,6,7,8 above



GlobTek, Inc.  
 www.globtek.com  
 186 Veterans Drive,  
 Northvale, NJ 07647  
 Tel. (201) 784-1000  
 Fax (201) 784-0111

Drawing Title: GTM96180-1848, ITE / Medical Power Supply/Class 2/Household Power Supply, Efficiency Level: VI, Case Color/Style: GlobTek Black, Wall Plug-in, Regulated Switchmode AC-DC Power Supply AC Adaptor, Input Rating: 100-240V~, 50-60 Hz, Interchangeable Blades <http://en.globtek.com/interchangeable-blades.php>, Output Rating: 18W, 48V@0.375A, Output Configuration: 1830 mm, 18/1C + Shield Cond, UL 1185, Power & Data ( 2 Jacks), RJ45 jacks mounted in 94V-O polycarbonate non-vented enclosure. Black color with White sillkscreen located on top of enclosure. Dimensions 50 X 45 X 28 mm., Ferrite: Core Size: 14.2\*28.5\*8.2, GlobTek Black, GT Cord # C0854, Pin Out: Computer OSU/POWER, Blades/Input Cord: (Order Separately), Approvals: S-Mark IEC/EN 60601-1 IP42 CB CB 230V CoC Tier 2 EAC cETLus cETLus cETLus cETLus 60601-1 3rd FCC ETL UL CCC CE Double Insulation CB cETLus UL1310 China RoHS Level VI CB LPS RoHS Ukraine VCCI WEEE PSE PSE PSE CAN ICES-3 RCM

Model No. GTM96180-1848

Part No./Ordering No. WR9QX375PPOENR6B

Rev D

**OUTPUT CORD AND CONNECTOR: POE1/C0854**

ACTUAL CONNECTORS, OVERMOLDS, FERRITES MAY VARY SLIGHTLY FROM THE PICTURE BELOW

CABLE TYPE	UL 1185
CABLE LENGTH (mm)	1830
CABLE TOLERANCE (mm)	+150-0
WIRE GAUGE (AWG)	18
CONDUCTORS	1C + Shield
HANK DIMENSION (mm)	80 ± 10
CABLE / CONNECTOR OVERMOLD COLOR	GlobTek Black
FERRITE TYPE / DIMENSION	Core Size: 14.2*28.5*8.2
FERRITE # OF TURNS ( <a href="#">Definition</a> )	2 Pass thru core (1 turns)
FERRITE DIMENSION FROM STRAIN RELIEF	125 ± 10
FERRITE DIMENSION FROM PLUG	N/A
PLUG TYPE	Power & Data ( 2 Jacks), RJ45 jacks mounted in 94V-O polycarbonate non-vented enclosure. Black color with White sillkscreen located on top of enclosure. Dimensions 50 X 45 X 28 mm.
OVER MOLD ORIENTATION	Straight
CONNECTOR PIN OUT:	Computer OSU/POWER
ADDITIONAL REQUIREMENTS	

1. OUTPUT CORD:  
 1CONDUCTOR+SHIELD,18AWG STRANDED WIRE,ROUND UL 1185, COLOR BLACK,LENGTH OF CORD:1930+150/-0MM CORD IS MEASURED FROM THE HOUSING TO THE END OF THE CONNECTOR. CABLE IS TO BE MARKED WITH WIRE GAUGE,AND ALL APPLICABLE RATING AND SAFETY APPROVALS. CABLE HAS MOLDED INLINE FERRITE (OPTIONAL)

2.OUTPUT CONNECTOR:  
 Wire stripping tin plating

3. STRAIN RELIEF MATERIAL REQUIREMENT: UL RECOGNIZED (GMFZZ)  
 PRODUCTS COMPLY WITH SABIC SE1, SE100 OR EQUIVALENT  
 TUBE MATERIAL REQUIREMENT: UL RECOGNIZED( LZFT2,YDPU2,YDRY2,YDTU2)  
 PRODUCTS WHICH ACCORDING WITH PEP,P1FE,PVC,TPE, NEOPRENE, POLYIMIDE OR MARKED VW-1,105 DEGREE, C,300V.

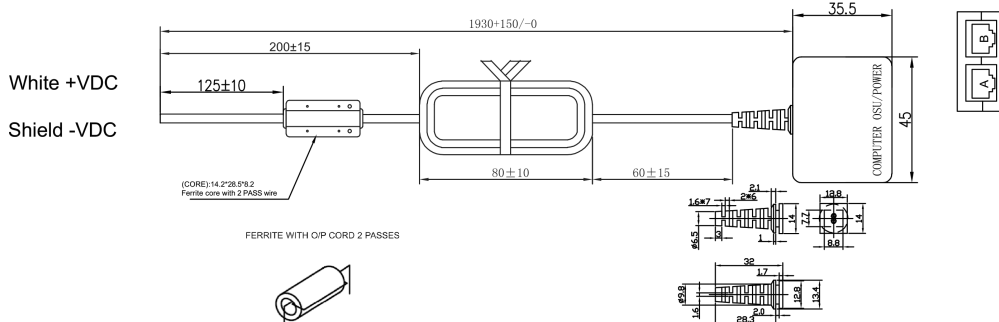
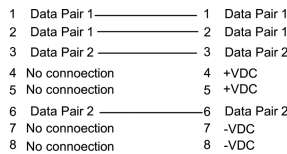

ADDITIONAL OUTPUT PLUG OPTIONS ARE AVAILABLE AT <http://www.globtek.com/connectors/>  
 STANDARD PLUGS AND CONNECTORS CAN BE SEEN ONLINE AT <http://www.globtek.com/connectors/>

GlobTek, Inc.  
 www.globtek.com  
 186 Veterans Drive,  
 Northvale, NJ 07647  
 Tel. (201) 784-1000  
 Fax (201) 784-0111

Drawing Title: GTM96180-1848, ITE / Medical Power Supply/Class 2/Household Power Supply, Efficiency Level: VI, Case Color/Style: GlobTek Black, Wall Plug-in, Regulated Switchmode AC-DC Power Supply AC Adaptor, Input Rating: 100-240V~, 50-60 Hz, Interchangeable Blades <http://en.globtek.com/interchangeable-blades.php>, Output Rating: 18W, 48V@0.375A, Output Configuration: 1830 mm, 18/1C + Shield Cond, UL 1185, Power & Data ( 2 Jacks), RJ45 jacks mounted in 94V-O polycarbonate non-vented enclosure. Black color with White sillkscreen located on top of enclosure. Dimensions 50 X 45 X 28 mm., Ferrite: Core Size: 14.2\*28.5\*8.2, GlobTek Black, GT Cord # C0854, Pin Out: Computer OSU/POWER, Blades/Input Cord: (Order Separately), Approvals: S-Mark IEC/EN 60601-1 IP42 CB CB 230V CoC Tier 2 EAC cETLus cETLus cETLus cETLus 60601-1 3rd FCC ETL UL CCC CE Double Insulation CB cETLus UL1310 China RoHS Level VI CB LPS RoHS Ukraine VCCI WEEE PSE PSE PSE CAN ICES-3 RCM

Model No. GTM96180-1848

Part No./Ordering No. WR9QX375PPOENR6B

Rev D

**LABEL:L-1186**

LABEL P/N: Standard GT  
 MATERIAL: Flat Thermal Transfer, Imprintable, Polyester Label and/or Pad Printed and/or Molded, and/or Laser Engraved in the case  
 BACKGROUND COLOR: Black if housing is Black, White or Silver if housing is White or Gray.  
 TEXT COLOR: White or Silver if label is Black Background for Black housing. Black if label is White or Silver background and Housing is White or Gray  
 LABEL WIDTH (mm): 29.8  
 LABEL HEIGHT (mm): 20.8

Below is the minimum information which will appear on the label. NOTE: in the logo area additional/actual positioning of symbols and text is subjected to change as per agency updates/requirements or additional model approvals become available. Regulatory certifications/label markings may be in logo area on the label or molded into the case housing outside the label area. Information will be shown via label and/or pad printed and/or molded and/or laser engraved in the case. \* Date code markings at GlobTek option.

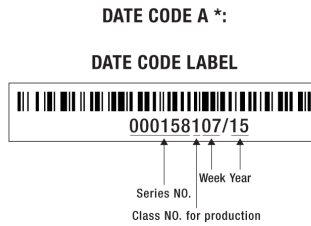

or  
**DATE CODE B \*:**  
 WWYY  
 WW = WEEK  
 YY = YEAR

A=ITE / Medical Power Supply/Class 2/Household Power Supply  
 B=P/N: (料号) WR9QX375PPOENR6B  
 C=Model (型号) GTM96180-1848  
 D=Input (输入) 100-240V~, 50-60 Hz, 0.6 A  
 E=Output (输出) 48 V 0.375 A ,18.0W

- AGENCY ONLINE DOCUMENTS <http://www.globtek.info/certs/GTM96180/>
- CE EC-Declaration for Medical [http://www.globtek.com/pdf/ec\\_declaration/a00a000000MjRI5EAN](http://www.globtek.com/pdf/ec_declaration/a00a000000MjRI5EAN)
- CE EC-Declaration for Industrial/Commercial/ITE [http://www.globtek.com/pdf/ec\\_declaration/a00a000000MjRI5EAN](http://www.globtek.com/pdf/ec_declaration/a00a000000MjRI5EAN)
- RoHS/RoHS2 Declaration [http://www.globtek.com/pdf/rohs\\_cert/01ta0000005yCQHAA2](http://www.globtek.com/pdf/rohs_cert/01ta0000005yCQHAA2)
- REACH Declaration [http://www.globtek.com/pdf/iso\\_certificates/REACH.pdf](http://www.globtek.com/pdf/iso_certificates/REACH.pdf)

GlobTek, Inc.  
www.globtek.com  
186 Veterans Drive,  
Northvale, NJ 07647  
Tel. (201) 784-1000  
Fax (201) 784-0111

Drawing Title: GTM96180-1848, ITE / Medical Power Supply/Class 2/Household Power Supply, Efficiency Level: VI, Case Color/Style: GlobTek Black, Wall Plug-in, Regulated Switchmode AC-DC Power Supply AC Adaptor, Input Rating: 100-240V~, 50-60 Hz, Interchangeable Blades <http://en.globtek.com/interchangeable-blades.php>, Output Rating: 18W, 48V@0.375A, Output Configuration: 1830 mm, 18/1C + Shield Cond, UL 1185, Power & Data ( 2 Jacks), RJ45 jacks mounted in 94V-O polycarbonate non-vented enclosure. Black color with White sillkscreen located on top of enclosure. Dimensions 50 X 45 X 28 mm., Ferrite: Core Size: 14.2\*28.5\*8.2, GlobTek Black, GT Cord # C0854, Pin Out: Computer OSU/POWER, Blades/Input Cord: (Order Separately), Approvals: S-Mark IEC/EN 60601-1 IP42 CB CB 230V CoC Tier 2 EAC cETLus cETLus cETLus cETLus 60601-1 3rd FCC ETL UL CCC CE Double Insulation CB cETLus UL1310 China RoHS Level VI CB LPS RoHS Ukraine VCCI WEEE PSE PSE PSE CAN ICES-3 RCM

Model No. GTM96180-1848

Part No./Ordering No. WR9QX375PPOENR6B

Rev D

Conflict Minerals Declaration

<http://www.globtek.com/pdf/conflict-minerals.pdf>

IPXY rating is based on 3rd party testing and customers should check suitability and test system level IPXY rating before ordering.

## Regulatory Certifications/Label Markings

LATEST PRODUCT/MODEL CERTIFICATIONS: <http://en.globtek.com/datasheet/id/a00a000000MjRl5>

AGENCY ONLINE DOCUMENTS: <http://www.globtek.info/certs/GTM96180/>

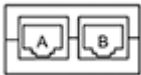

Computer OSU/POWER

GlobTek, Inc.  
 www.globtek.com  
 186 Veterans Drive,  
 Northvale, NJ 07647  
 Tel. (201) 784-1000  
 Fax (201) 784-0111

Drawing Title: GTM96180-1848, ITE / Medical Power Supply/Class 2/Household Power Supply, Efficiency Level: VI, Case Color/Style: GlobTek Black, Wall Plug-in, Regulated Switchmode AC-DC Power Supply AC Adaptor, Input Rating: 100-240V~, 50-60 Hz, Interchangeable Blades <http://en.globtek.com/interchangeable-blades.php>, Output Rating: 18W, 48V@0.375A, Output Configuration: 1830 mm, 18/1C + Shield Cond, UL 1185, Power & Data ( 2 Jacks), RJ45 jacks mounted in 94V-O polycarbonate non-vented enclosure. Black color with White silkscreen located on top of enclosure. Dimensions 50 X 45 X 28 mm., Ferrite: Core Size: 14.2\*28.5\*8.2, GlobTek Black, GT Cord # C0854, Pin Out: Computer OSU/POWER, Blades/Input Cord: (Order Separately), Approvals: S-Mark IEC/EN 60601-1 IP42 CB CB 230V CoC Tier 2 EAC cETLus cETLus cETLus cETLus 60601-1 3rd FCC ETL UL CCC CE Double Insulation CB cETLus UL1310 China RoHS Level VI CB LPS RoHS Ukraine VCCI WEEE PSE PSE PSE CAN ICES-3 RCM

Model No. GTM96180-1848

Part No./Ordering No. WR9QX375PPOENR6B

Rev D

**PACKAGING**

Packing Spec P/N: Cellular packaging  
 Box Qty: 60  
 Gift Box Size (mm): 90.5\*73\*53  
 Gift Box Color: White  
 Master Carton Size (mm): 388\*380\*245  
 Master GW (Kg): 15.2 kg  
 BLADES INCLUDED: None:  
 BLADE/CORD INSTALLED: None:

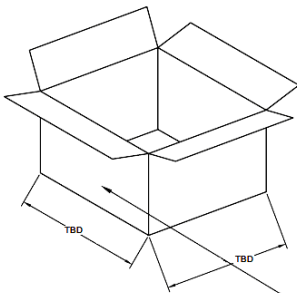
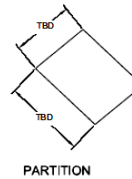
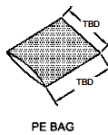
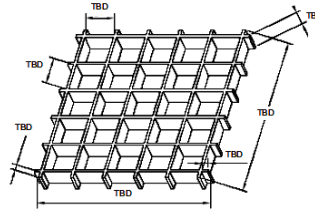
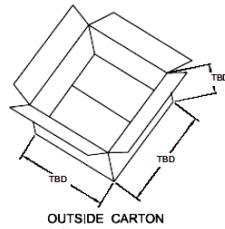
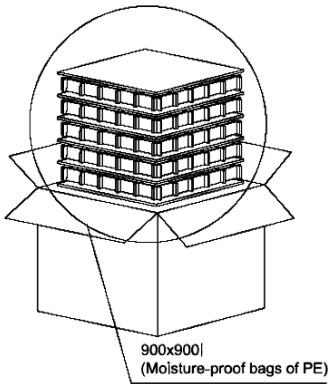

**GlobTek, Inc.**  
 CHINA MANUFACTURING  
 MADE IN CHINA  
 GLOBTEK L/R #  
 GLOBTEK PART #  
 Quantity/Carton:  
 Carton # of #

GlobTek, Inc.  
www.globtek.com  
186 Veterans Drive,  
Northvale, NJ 07647  
Tel. (201) 784-1000  
Fax (201) 784-0111

Drawing Title: GTM96180-1848, ITE / Medical Power Supply/Class 2/Household Power Supply, Efficiency Level: VI, Case Color/Style: GlobTek Black, Wall Plug-in, Regulated Switchmode AC-DC Power Supply AC Adaptor, Input Rating: 100-240V~, 50-60 Hz, Interchangeable Blades <http://en.globtek.com/interchangeable-blades.php>, Output Rating: 18W, 48V@0.375A, Output Configuration: 1830 mm, 18/1C + Shield Cond, UL 1185, Power & Data ( 2 Jacks), RJ45 jacks mounted in 94V-O polycarbonate non-vented enclosure. Black color with White sillkscreen located on top of enclosure. Dimensions 50 X 45 X 28 mm., Ferrite: Core Size: 14.2\*28.5\*8.2, GlobTek Black, GT Cord # C0854, Pin Out: Computer OSU/POWER, Blades/Input Cord: (Order Separately), Approvals: S-Mark IEC/EN 60601-1 IP42 CB CB 230V CoC Tier 2 EAC cETLus cETLus cETLus cETLus 60601-1 3rd FCC ETL UL CCC CE Double Insulation CB cETLus UL1310 China RoHS Level VI CB LPS RoHS Ukraine VCCI WEEE PSE PSE PSE CAN ICES-3 RCM

Model No. GTM96180-1848

Part No./Ordering No. WR9QX375PPOENR6B

Rev D

## INSTRUCTION SHEET

Q Blades Instruction Sheet (not required to be packaged with product)

Insertion Instructions: <http://www.globtek.com/pdf/Instructions-Interchangeable-Blades.pdf>

This manual is Provided to customer within the product specification - it is the responsibility of

the OEM/customer to provide the end system user instructions + warnings for the use of this product in the end system. By accepting this specification the customer/OEM Agrees to these terms.

## USER MANUAL FOR Q-BLADE SERIES SWITCHING POWER SUPPLIES

Manual del Usuario. Fuentes de Alimentación Series Q-Blade

**WARNING! RISK OF FIRE! SHOCK HAZARD!**: To prevent electric shock, do not remove the cover. No user-serviceable parts inside. This unit contains hazardous voltages and should only be opened by a trained and qualified technician. Do not use if bent, cracked, modified or compromised. To avoid the possibility of electric shock, disconnect electric power to the product before connecting or disconnecting.

**Advertencia! Riesgo de Fuego! Peligro de Choque eléctrico!**

No contiene dentro componentes servibles para el usuario. Desconecte el cable de alimentación antes de quitar la cubierta.

**INDOOR USE ONLY!**

Únicamente para uso en el interior.

**POWER SUPPLY BLADE/CORD**: AC Mains voltage should be provided to the power supply by a power supply cords approved to

the national standards in which it will be used. Please use the below table as a guideline for Suitable Power cords.

**CABLE DE ALIMENTACIÓN**: El voltaje de la CA debe proporcionarse a la fuente de alimentación mediante

los cables de alimentación aprobados conforme a las normas nacionales según las cuales será utilizada. Utilice por favor la tabla mencionada aquí abajo como guía para los cables eléctricos adecuados.

1. Class II model NEMA 1-15P AC power plug with 2 prongs, Q-NA(R)
2. Australian AS 3112 configuration: SAA 2 pins Class II, Q-SAA(R)
3. UK BS 1363 configuration: UK 2 pins Class II, Q-UKY(R)
4. European CEE 7/16 configuration: Europlug 2 PINS, Class II, Q-EU(R)
5. Korean KS C8305 configuration: Q-KR(R)
6. Argentina IRAM 2073 configuration: 2 pins, Class II Q-AR(R)
7. China GR 2099 configuration: 2 pins, Class II Q-CN(R)
8. India configuration: 2 pins, Class II, Q-IN(R)
9. IEC320/C18 Inlet

**FUSING**: Internal fuse for Line is provided in the power supply. A blown internal fuse is an indication of catastrophic failure

GlobTek, Inc.  
 www.globtek.com  
 186 Veterans Drive,  
 Northvale, NJ 07647  
 Tel. (201) 784-1000  
 Fax (201) 784-0111

Drawing Title: GTM96180-1848, ITE / Medical Power Supply/Class 2/Household Power Supply, Efficiency Level: VI, Case Color/Style: GlobTek Black, Wall Plug-in, Regulated Switchmode AC-DC Power Supply AC Adaptor, Input Rating: 100-240V~, 50-60 Hz, Interchangeable Blades <http://en.globtek.com/interchangeable-blades.php>, Output Rating: 18W, 48V@0.375A, Output Configuration: 1830 mm, 18/1C + Shield Cond, UL 1185, Power & Data ( 2 Jacks), RJ45 jacks mounted in 94V-O polycarbonate non-vented enclosure. Black color with White sillkscreen located on top of enclosure. Dimensions 50 X 45 X 28 mm., Ferrite: Core Size: 14.2\*28.5\*8.2, GlobTek Black, GT Cord # C0854, Pin Out: Computer OSU/POWER, Blades/Input Cord: (Order Separately), Approvals: S-Mark IEC/EN 60601-1 IP42 CB CB 230V CoC Tier 2 EAC cETLus cETLus cETLus cETLus 60601-1 3rd FCC ETL UL CCC CE Double Insulation CB cETLus UL1310 China RoHS Level VI CB LPS RoHS Ukraine VCCI WEEE PSE PSE PSE CAN ICES-3 RCM

Model No. GTM96180-1848	
Part No./Ordering No. WR9QX375PPOENR6B	Rev D

of circuit component(s). Repair must be performed by GlobTek, Inc. authorized personnel. Fuses must be replaced with same type and ratings per GlobTek internal documentation.

FUSIBLES: La fuente de alimentación provee un fusible interno para la línea. Un fusible interno quemado es un indicador de una falla catastrófica de los componentes del circuito. La reparación debe ser hecha por personal autorizado de GlobTek, Inc. Los fusibles se deben reemplazar por los mismos tipos y rangos que la documentación interna de GlobTek mencione.

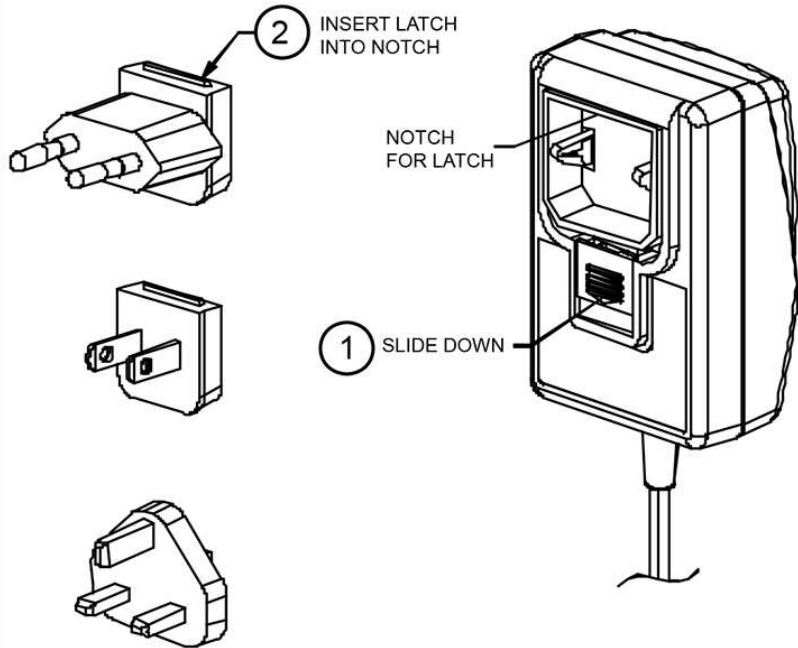

This symbol on an instrument indicates that the user should refer to the operating instructions located in the manual.