



Chipsmall Limited consists of a professional team with an average of over 10 year of expertise in the distribution of electronic components. Based in Hongkong, we have already established firm and mutual-benefit business relationships with customers from,Europe,America and south Asia,supplying obsolete and hard-to-find components to meet their specific needs.

With the principle of “Quality Parts,Customers Priority,Honest Operation,and Considerate Service”,our business mainly focus on the distribution of electronic components. Line cards we deal with include Microchip,ALPS,ROHM,Xilinx,Pulse,ON,Everlight and Freescale. Main products comprise IC,Modules,Potentiometer,IC Socket,Relay,Connector.Our parts cover such applications as commercial,industrial, and automotives areas.

We are looking forward to setting up business relationship with you and hope to provide you with the best service and solution. Let us make a better world for our industry!



Contact us

Tel: +86-755-8981 8866 Fax: +86-755-8427 6832

Email & Skype: info@chipsmall.com Web: www.chipsmall.com

Address: A1208, Overseas Decoration Building, #122 Zhenhua RD., Futian, Shenzhen, China





MODEL: WSP-4508-7
PRODUCT: Water Resistant Speaker
EDITION: A/2017



Specification	Unit	WSP-4508-7
AC Impedance	Ω	$8 \pm 15\%$ at 1000Hz
Rated Input Power	Watt	3.0
Max Input Power	Watt	4.0
Resonant Frequency	Hz	$900 \pm 20\%$
Frequency Range	Hz	F0 ~ 5.0KHz, Average SPL ± 10 dB
Output Sound Pressure Level	dB	101 ± 3 dB 0.1 Watt/ 10 cm, AVG. at 0.8, 1.0, 1.2, 1.5KHz
Operating Temperature	$^{\circ}\text{C}$	$-20^{\circ}\text{C} \sim +50^{\circ}\text{C}$
Storage Temperature	$^{\circ}\text{C}$	$-40^{\circ}\text{C} \sim +60^{\circ}\text{C}$
Dimension	mm	$\phi 45.0 \times H12.9$
Distortion		5% maximum at 1000Hz, 3.0W
Polarity		Diaphragm shall move forward when a positive DC current is applied to the "+" or "Marked" Terminal
Load Test		Audio Signal Generator at 4.9 Volt Total 48 hours and 20Hz ~ 20KHz resonant frequency
Abnormal Sound Test		Must be normal tested at 4.9 Volt sine wave
Ingress Rating	IP65	

DIMENSIONS

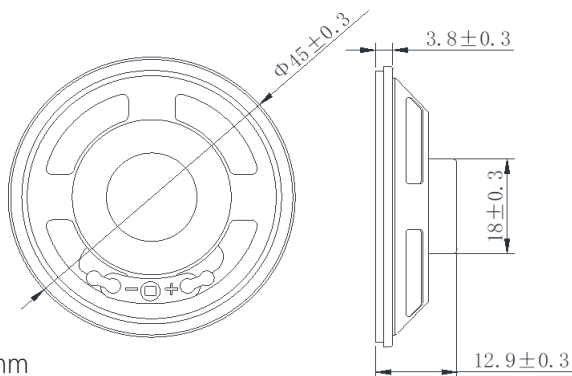

FREQUENCY RESPONSE

