



Chipsmall Limited consists of a professional team with an average of over 10 year of expertise in the distribution of electronic components. Based in Hongkong, we have already established firm and mutual-benefit business relationships with customers from,Europe,America and south Asia,supplying obsolete and hard-to-find components to meet their specific needs.

With the principle of “Quality Parts,Customers Priority,Honest Operation,and Considerate Service”,our business mainly focus on the distribution of electronic components. Line cards we deal with include Microchip,ALPS,ROHM,Xilinx,Pulse,ON,Everlight and Freescale. Main products comprise IC,Modules,Potentiometer,IC Socket,Relay,Connector.Our parts cover such applications as commercial,industrial, and automotives areas.

We are looking forward to setting up business relationship with you and hope to provide you with the best service and solution. Let us make a better world for our industry!



Contact us

Tel: +86-755-8981 8866 Fax: +86-755-8427 6832

Email & Skype: info@chipsmall.com Web: www.chipsmall.com

Address: A1208, Overseas Decoration Building, #122 Zhenhua RD., Futian, Shenzhen, China





WTB4-3P2271

W4-3

PHOTOELECTRIC SENSORS

SICK
Sensor Intelligence.



Illustration may differ



Ordering information

Type	Part no.
WTB4-3P2271	1042190

Other models and accessories → www.sick.com/W4-3

Detailed technical data

Features

Sensor/ detection principle	Photoelectric proximity sensor, Background suppression
Dimensions (W x H x D)	16 mm x 39.5 mm x 12 mm
Housing design (light emission)	Rectangular
Sensing range max.	4 mm ... 150 mm ¹⁾
Sensing range	15 mm ... 150 mm ¹⁾
Type of light	Visible red light
Light source	PinPoint LED ²⁾
Light spot size (distance)	5 mm x 28 mm (50 mm)
Wave length	650 nm
Adjustment	Potentiometer, 5 turns
Special applications	Detecting perforated objects, Detecting objects with position tolerances, Detecting small objects

¹⁾ Object with 90 % reflectance (referred to standard white, DIN 5033).

²⁾ Average service life: 100,000 h at T_J = +25 °C.

Mechanics/electronics

Supply voltage	10 V DC ... 30 V DC ¹⁾
Ripple	< 5 V _{pp} ²⁾
Power consumption	≤ 20 mA ³⁾
Switching output	PNP
Output function	Complementary
Switching mode	Light/dark switching
Output current I_{max.}	≤ 100 mA
Response time	< 0.5 ms ⁴⁾
Switching frequency	1,000 Hz ⁵⁾
Connection type	Male connector M8, 4-pin
Circuit protection	A ⁶⁾ C ⁷⁾ D ⁸⁾
Protection class	III
Weight	30 g
Housing material	Plastic, ABS
Optics material	Plastic, PMMA
Enclosure rating	IP67 IP66
Special feature	Line-shaped light spot
Ambient operating temperature	-40 °C ... +60 °C
Ambient storage temperature	-40 °C ... +75 °C
UL File No.	NRKH.E181493 & NRKH7.E181493

¹⁾ Limit values.

²⁾ May not exceed or fall below U_v tolerances.

³⁾ Without load.

⁴⁾ Signal transit time with resistive load.

⁵⁾ With light/dark ratio 1:1.

⁶⁾ A = V_S connections reverse-polarity protected.

⁷⁾ C = interference suppression.

⁸⁾ D = outputs overcurrent and short-circuit protected.

Classifications

ECl@ss 5.0	27270904
ECl@ss 5.1.4	27270904
ECl@ss 6.0	27270904
ECl@ss 6.2	27270904
ECl@ss 7.0	27270904
ECl@ss 8.0	27270904
ECl@ss 8.1	27270904
ECl@ss 9.0	27270904
ETIM 5.0	EC002719
ETIM 6.0	EC002719

UNSPSC 16.0901

39121528

Connection diagram

cd-083

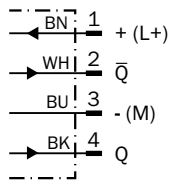

Light spot size

WTB4-3, line-shaped light spot

Lightspot: line width

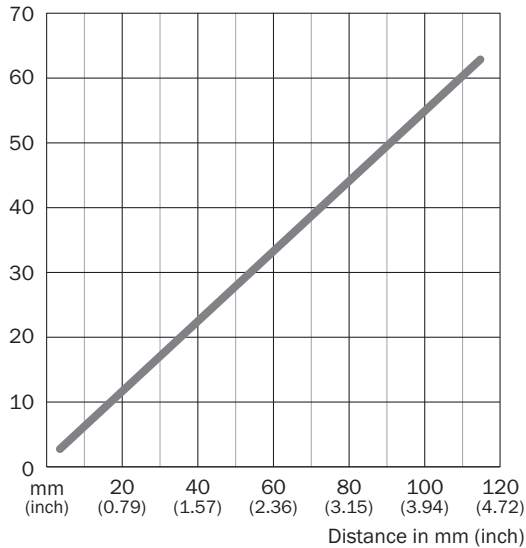

Sensing range diagram

WTB4-3, line-shaped light spot

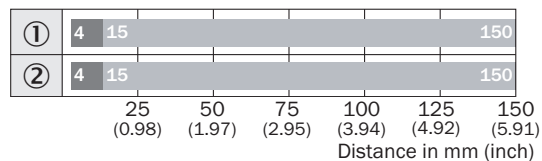

■ Sensing range max. ■ Sensing range

① Sensing range on white, 90% remission

② Sensing range on black, 6% remission

Dimensional drawing (Dimensions in mm (inch))

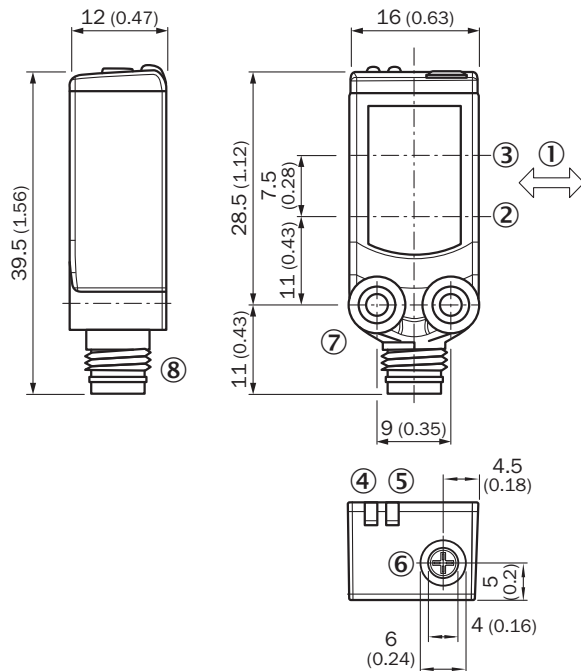

WTx4-3, potentiometer







- ① Standard direction of the material being detected
- ② Optical axis, sender
- ③ Optical axis, receiver
- ④ LED indicator yellow: Status of received light beam
- ⑤ LED indicator green: Supply voltage active
- ⑥ Potentiometer
- ⑦ Threaded mounting hole M3
- ⑧ Connection

Recommended accessories

Other models and accessories → www.sick.com/W4-3

	Brief description	Type	Part no.
Universal bar clamp systems			
	Plate N08 for universal clamp bracket, Zinc plated steel (sheet), Zinc die cast (clamping bracket), Universal clamp (5322626), mounting hardware	BEF-KHS-N08	2051607
Mounting brackets and plates			
	Mounting bracket for wall mounting, Stainless steel 1.4571, mounting hardware included	BEF-W4-A	2051628
	Mounting bracket for floor mounting, Stainless steel 1.4571, mounting hardware included	BEF-W4-B	2051630

	Brief description	Type	Part no.
Plug connectors and cables			
	Head A: female connector, M8, 4-pin, straight, A-coded Head B: Flying leads Cable: Sensor/actuator cable, PVC, unshielded, 2 m	YF8U14-020VA3XLEAX	2095888
	Head A: female connector, M8, 4-pin, straight, A-coded Head B: Flying leads Cable: Sensor/actuator cable, PVC, unshielded, 5 m	YF8U14-050VA3XLEAX	2095889
	Head A: female connector, M8, 4-pin, angled, A-coded Head B: Flying leads Cable: Sensor/actuator cable, PVC, unshielded, 2 m	YG8U14-020VA3XLEAX	2095962
	Head A: female connector, M8, 4-pin, angled, A-coded Head B: Flying leads Cable: Sensor/actuator cable, PVC, unshielded, 5 m	YG8U14-050VA3XLEAX	2095963
	Head A: female connector, M8, 4-pin, straight Head B: - Cable: unshielded	DOS-0804-G	6009974
	Head A: female connector, M8, 4-pin, angled Head B: - Cable: unshielded	DOS-0804-W	6009975
	Head A: male connector, M8, 4-pin, straight Head B: - Cable: unshielded	STE-0804-G	6037323

SICK AT A GLANCE

SICK is one of the leading manufacturers of intelligent sensors and sensor solutions for industrial applications. A unique range of products and services creates the perfect basis for controlling processes securely and efficiently, protecting individuals from accidents and preventing damage to the environment.

We have extensive experience in a wide range of industries and understand their processes and requirements. With intelligent sensors, we can deliver exactly what our customers need. In application centers in Europe, Asia and North America, system solutions are tested and optimized in accordance with customer specifications. All this makes us a reliable supplier and development partner.

Comprehensive services complete our offering: SICK LifeTime Services provide support throughout the machine life cycle and ensure safety and productivity.

For us, that is “Sensor Intelligence.”

WORLDWIDE PRESENCE:

Contacts and other locations www.sick.com