



Chipsmall Limited consists of a professional team with an average of over 10 year of expertise in the distribution of electronic components. Based in Hongkong, we have already established firm and mutual-benefit business relationships with customers from,Europe,America and south Asia,supplying obsolete and hard-to-find components to meet their specific needs.

With the principle of “Quality Parts,Customers Priority,Honest Operation,and Considerate Service”,our business mainly focus on the distribution of electronic components. Line cards we deal with include Microchip,ALPS,ROHM,Xilinx,Pulse,ON,Everlight and Freescale. Main products comprise IC,Modules,Potentiometer,IC Socket,Relay,Connector.Our parts cover such applications as commercial,industrial, and automotives areas.

We are looking forward to setting up business relationship with you and hope to provide you with the best service and solution. Let us make a better world for our industry!



## Contact us

Tel: +86-755-8981 8866 Fax: +86-755-8427 6832

Email & Skype: info@chipsmall.com Web: www.chipsmall.com

Address: A1208, Overseas Decoration Building, #122 Zhenhua RD., Futian, Shenzhen, China





## Surface Mount LVCMOS Clock Oscillator Series

# CONNOR WINFIELD



2111 Comprehensive Drive

Aurora, Illinois 60505

Phone: 630-851-4722

Fax: 630-851-5040

www.conwin.com

### Description:

The Connor Winfield Xxxx - Series is a 5.0x7.0mm Surface Mount, LVCMOS, Fixed Frequency Crystal Controlled Oscillator (XO) designed for applications requiring tight frequency stability, wide temperature range and low jitter. Operating at 2.5V or 3.3V supply voltage, the Xxxx - Series provides an LVCMOS Output with enable / disable function. The surface mount package is designed for high-density mounting and is optimum for mass production.



### Features:

- 5.0 x7.0mm Surface Mount Package
- 2.5V or 3.3V Operation
- LVCMOS Output Logic
- Frequency Stabilities Available:
  - X14x / X24x / X34x / X44x: +/-20ppm
  - X11x / X21x / X31x / X41x: +/-25ppm
  - X12x / X22x / X32x / X42x: +/-50ppm
  - X13x / X23x / X33x / X43x: +/-100ppm
- Temperature Ranges Available:
  - X1xx Series: 0 to 70°C
  - X2xx Series: -40 to 85°C
  - X3xx Series: 0 to 85°C
  - X4xx Series: -20 to 70°C
- Low Jitter <0.2 ps RMS
- Tri-State Enable/Disable
- Tape and Reel Packaging
- RoHS Compliant / Lead (Pb) Free

### Absolute Maximum Ratings

Parameter	Minimum	Nominal	Maximum	Units	Notes
Storage Temperature	-55	-	125	°C	
Supply Voltage (Vcc)	-0.5	-	5.0	Vdc	
Input Voltage (OE)	-0.5	-	Vcc + 0.5	Vdc	

*Absolute Ratings: Stresses beyond those listed under "absolute maximum ratings" may cause permanent damage to the device. These are stress ratings only. The functional operation of the device at those or any other conditions beyond those indicated under "recommended operating conditions" is not implied. Exposure to conditions outside the "recommended operating conditions" for any extended period of time may adversely impact device reliability and result in failures not covered by warranty.*

### Operating Specifications

Parameter	Minimum	Nominal	Maximum	Units	Notes
Output Frequency (Fo)					
Models Xx4x, Xx1x Series	20	-	200	MHz	1
Models Xx2x, Xx3x Series	20	-	225	MHz	
Total Frequency Tolerance (See Ordering Information or Model Matrix for full part number, page 3)					
Model Xx4x	-20	-	20	ppm	2
Model Xx1x	-25	-	25	ppm	2
Model Xx2x	-50	-	50	ppm	2
Model Xx3x	-100	-	100	ppm	2
Operating Temperature Range					
Model X1xx	0	-	70	°C	
Model X2xx	-40	-	85	°C	
Model X3xx	0	-	85	°C	
Model X4xx	-20	-	70	°C	
Supply Voltage (Vcc)					
Model Xxx2,	2.375	2.5	2.625	Vdc	
Model Xxx3	3.135	3.3	3.465	Vdc	
Supply Current (Icc)					
40 to 79.999 MHz	-	-	15	mA	
80 to 89.999 MHz	-	-	26	mA	
90 to 124.999 MHz	-	-	36	mA	
125 to 164.999 MHz	-	-	46	mA	
165 to 225 MHz	-	-	61	mA	
Jitter:					
Period Jitter	-	3.0	5.0	ps RMS	
Integrated Phase Jitter (BW = 12 KHz to 20 MHz)					
Fo = 156.25 MHz	-	0.15	0.20	ps RMS	
Fo = 50 MHz	-	0.07	0.10	ps RMS	
Jitter Peak to Peak (BW = 10 Hz to 20 MHz)	-	-	25	ps RMS	
SSB Phase Noise	(Fo = 50.0 MHz)		(Fo = 156.25 MHz)		
@ 10 Hz offset	-60		-60	dBc/Hz	
@ 100 Hz offset	-110		-90	dBc/Hz	
@ 1 KHz offset	-145		-120	dBc/Hz	
@ 10 KHz offset	-156		-135	dBc/Hz	
@ 100 KHz offset	-162		-142	dBc/Hz	
@ 1 MHz offset	-164		-148	dBc/Hz	
@ 10 MHz offset	-165		-154	dBc/Hz	
Start-Up Time	-	-	2	ms	







## OE Input Characteristics

Parameter	Minimum	Nominal	Maximum	Units	Notes
Enable Voltage (High) (V <sub>ih</sub> )	70%V <sub>cc</sub>	-	-	V <sub>dc</sub>	3
Disable Voltage (Low) (V <sub>il</sub> )	-	-	30%V <sub>cc</sub>	V <sub>dc</sub>	3
Enable Time	-	-	2	ms	
Disable Time	-	-	200	ns	
Output Disable Current (Standby Current) (I <sub>cc</sub> )	-	-	10	uA	

## CMOS Output Characteristics

Parameter	Minimum	Nominal	Maximum	Units	Notes
Load	-	15	-	pF	
3.3 V <sub>dc</sub> Models					
Output Voltage: High (V <sub>oh</sub> )	V <sub>cc</sub> -0.4	-	-	V	
Low (V <sub>ol</sub> )	-	-	0.4	V	
Output Current: High (I <sub>oh</sub> )	-8	-	-	mA	
Low (I <sub>ol</sub> )	-	-	8	mA	
Duty Cycle at 50% of V <sub>cc</sub>	45	50	55	%	
Rise / Fall Time: 10% to 90%	-	1	2	ns	

### Notes:

- 1) Maximum output frequency for the +/-20 ppm and the +/-25 ppm models is 200 MHz.
- 2) Inclusive of calibration @ 25°C, frequency vs. temperature stability, supply voltage change, load change, shock and vibration, 10 years aging.
- 3) When the oscillator is disabled, the outputs are high impedance. Output is enabled with no connection on pad 1.

## Package Characteristics

Package	Ceramic Surface Mount Package
Moisture Sensitivity Level	MSL-1
Termination Finish	0.7um Gold (Au) over 2.5um Nickel (Ni)

## Environmental Characteristics

Shock	500 G's 1ms, Halfsine, 3 shocks per direction, per MIL-STD 202G, Method 213B Test Condition D.
Sinusoidal Vibration	0.06" D.A. or 10G's Peak, 10 to 500 Hz, per MIL-STD-202G, Method 204D, Test Condition A.
Random Vibration	5.35 G's rms. 20 to 2000 Hz per MIL-STD-202G, Method 214, Test Condition 1A, 15 minutes each axis.
Moisture	10 cycles, 95% RH, Per MIL-STD-202G, Method 112.
Marking Permanency	Per MIL-STD-202G, Method 215J.
Solder Process	RoHS compliant, lead free. See solder profile on page 3.

## Package Outline

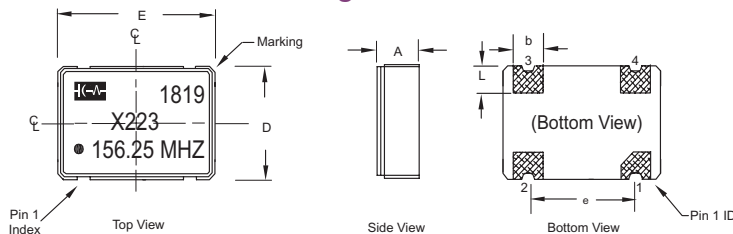

Symbol	mm			inches		
	Min	Nom.	Max.	Min	Nom.	Max.
A	-	-	1.5	-	-	0.060
D	4.85	5.0	5.15	0.191	0.197	0.203
E	6.86	7.00	7.16	0.270	0.275	0.282
A1	-	0.65	-	-	0.0265	-
L	-	1.20	-	-	0.0470	-
b	-	1.40	-	-	0.055	-
e	-	5.08	-	-	0.200	-

## Suggested Pad Layout

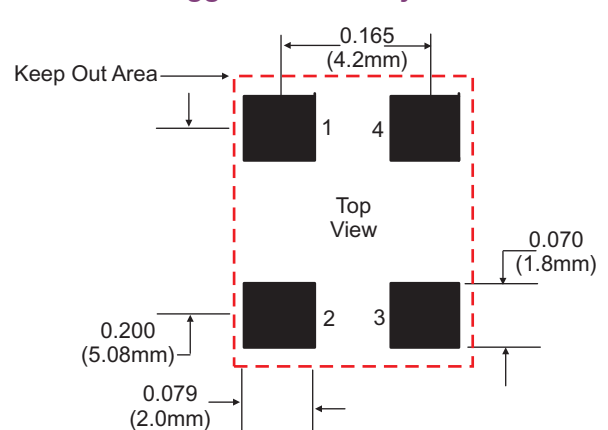

## Pad Connections

- 1: Enable / Disable (OE)
- 2: Ground (Cover)
- 3: Output
- 4: Supply Voltage (V<sub>cc</sub>)

## Enable / Disable Function (OE)

Function (Pad 1)	Output
High (V <sub>ih</sub> ) or Open	Enabled
Low (V <sub>il</sub> )	Disabled
	(High Impedance)

Bulletin	Sm118
Page	2 of 4
Revision	13
Date	31 July 2018



## Ordering Information

<b>X</b>	<b>1</b>	<b>2</b>	<b>3</b>	<b>- 156.25M</b>
Type LVCMOS Clock Series 5x7 mm	Temperature Range 1 = 0 to 70°C 2 = -40 to 85°C 3 = 0 to 85°C 4 = -20 to 70°C	Frequency Stability 4 = ±20 ppm 1 = ±25 ppm 2 = ±50 ppm 3 = ±100 ppm	Supply Voltage 2 = 2.5 Vdc 3 = 3.3 Vdc	Output Frequency Frequency Format -xxx.xM Min -xxx.xxxxxM Max *Amount of numbers after the decimal point. M = MHz

Example Part Numbers:

X123-156.25M = LVCMOS Output, 0 to 70, +/-50 ppm, 3.3 Vdc, E/D Pad 1, Output Frequency 156.25 MHz  
X412-100.0M = LVCMOS Output, -20 to 70, +/-25 ppm, 2.5 Vdc, E/D Pad 1, Output Frequency 100.0 MHz

## Model Matrix

Frequency Tolerance ±20 ppm	Frequency Tolerance ±25 ppm	Frequency Tolerance ±50 ppm	Frequency Tolerance ±100 ppm	Supply Voltage	Temperature Range
X142	X112	X122	X132	2.5Vdc	0 to 70°C
X242	X212	X222	X232	2.5Vdc	-40 to 85°C
X342	X312	X322	X332	2.5Vdc	0 to 85°C
X442	X412	X422	X432	2.5Vdc	-20 to 70°C
X143	X113	X123	X133	3.3Vdc	0 to 70°C
X243	X213	X223	X233	3.3Vdc	-40 to 85°C
X343	X313	X323	X333	3.3Vdc	0 to 85°C
X443	X413	X423	X433	3.3Vdc	-20 to 70°C

## Solder Profile

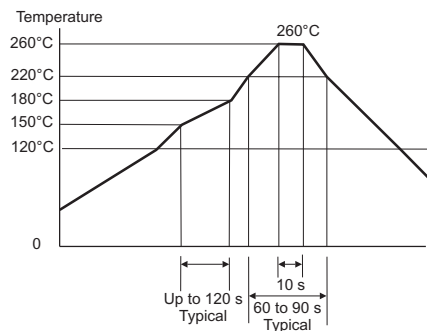

Meets IPC/JEDEC J-STD-020C

## Test Circuit

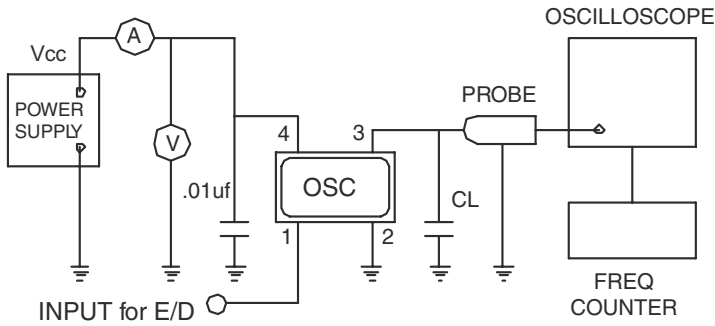

## CMOS Output Waveform

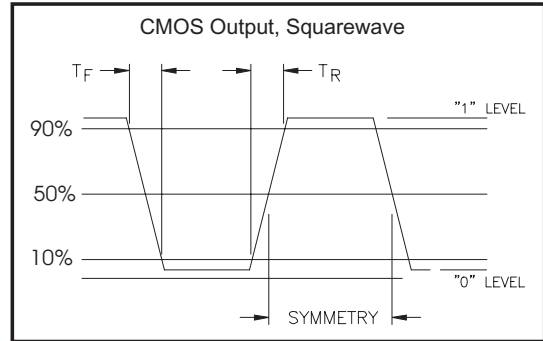

## Typical Phase Noise Plot for Model X213-050.0M

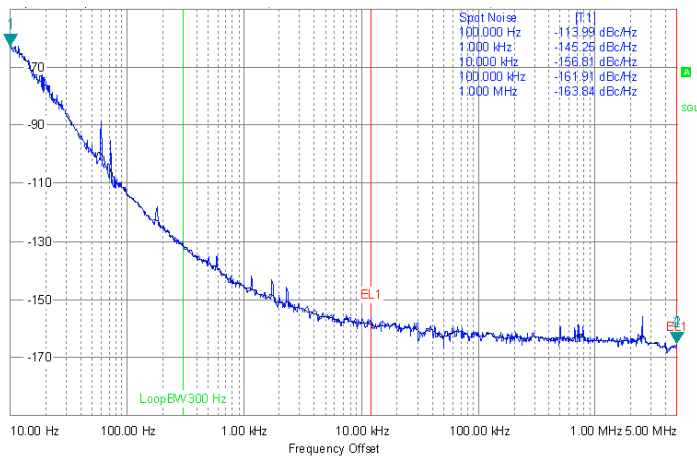

## Typical Phase Noise Plot for Model X123-156.25M

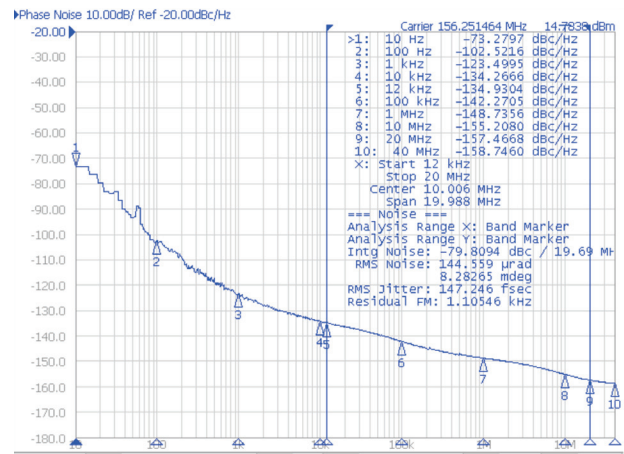

## Tape and Reel Dimensions

