



Chipsmall Limited consists of a professional team with an average of over 10 year of expertise in the distribution of electronic components. Based in Hongkong, we have already established firm and mutual-benefit business relationships with customers from,Europe,America and south Asia,supplying obsolete and hard-to-find components to meet their specific needs.

With the principle of “Quality Parts,Customers Priority,Honest Operation,and Considerate Service”,our business mainly focus on the distribution of electronic components. Line cards we deal with include Microchip,ALPS,ROHM,Xilinx,Pulse,ON,Everlight and Freescale. Main products comprise IC,Modules,Potentiometer,IC Socket,Relay,Connector.Our parts cover such applications as commercial,industrial, and automotives areas.

We are looking forward to setting up business relationship with you and hope to provide you with the best service and solution. Let us make a better world for our industry!



## Contact us

Tel: +86-755-8981 8866 Fax: +86-755-8427 6832

Email & Skype: info@chipsmall.com Web: www.chipsmall.com

Address: A1208, Overseas Decoration Building, #122 Zhenhua RD., Futian, Shenzhen, China



## Features

- 21.0 dB Small Signal Gain
- +22.0 dBm Psat
- +20.0 dBm P1dB
- +30.5 dBm Output IP3
- Variable Gain with Adjustable Bias
- Lead-free 3 mm 16-lead PQFN Package
- 100% RF, DC and Output Power Testing
- RoHS\* Compliant and 260°C Reflow Compatible

## Description

The XB1014-QT is a three stage 37.0-40.0 GHz GaAs MMIC buffer amplifier that has a small signal gain of 21.0 dB and 20.0 dBm P1dB output compression point. The device also provides variable gain regulation with adjustable bias. The device is ideally suited as an LO or RF buffer stage with broadband performance at a very low cost.

The device comes in an RoHS compliant 3x3mm QFN surface mount package offering excellent RF and thermal properties. This device has been designed for use in 38 GHz Point-to-Point Microwave Radio applications.

## Ordering Information

Part Number	Package
XB1014-QT-0G00	bulk quantity
XB1014-QT-0G0T	tape and reel
XB1014-QT-EV1	evaluation board

## Functional Schematic

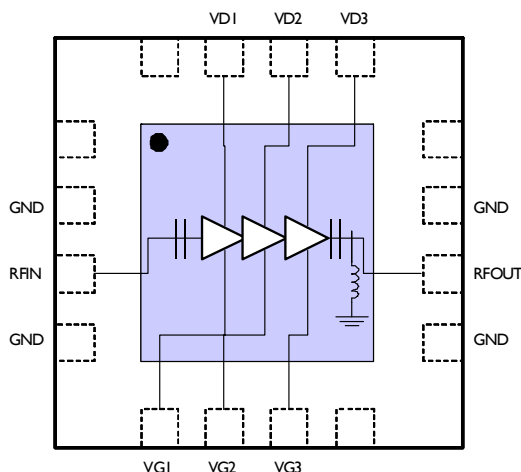

## Pin Configuration<sup>1</sup>

Pin No.	Function	Pin No.	Function
3	RF Input	10	RF Output
5	Gate 1 Bias	13	Drain 3 Bias
6	Gate 2 Bias	14	Drain 2 Bias
7	Gate 3 Bias	15	Drain 1 Bias

1. The exposed pad centered on the package bottom must be connected to RF and DC ground.

\* Restrictions on Hazardous Substances, European Union Directive 2002/95/EC.

**Electrical Specifications: 37-40.15 GHz (Ambient Temperature T = 25°C)**

Parameter	Units	Min.	Typ.	Max.
Input Return Loss (S11)	dB	-	7.0	40.0
Output Return Loss (S22)	dB	-	10.0	-
Small Signal Gain (S21)	dB	17.0	21.0	-
Reverse isolation (S12)	dB	-	40.0	24.5
Output Power for 1dB Compression Point (P1dB)	dBm	-	20.0	-
Saturated Output Power (Psat)	dBm	19.5	22.0	-
Output IP3 (Psci = 4 dBm)	dBm	27.0	30.5	-
Drain Bias Voltage (Vd1,2,3)	V	-	4.0	4.0
Gate Bias Voltage (Vg1,2,3)	V	-1.0	-0.3	-0.1
Supply Current (Id1,2,3)	mA	-	250	300

**Absolute Maximum Ratings** <sup>2,3</sup>

Parameter	Absolute Max.
Supply Voltage (Vd1,2,3)	+4.3 V
Supply Voltage (Vg1,2,3)	-1.5V < Vg < 0V
Input Power (Pin)	+20 dBm
Abs. Max Junction/Channel Temp	MTTF Graph
Max. Operating Junction/Channel Temp	150°C
Continuous Power Dissipation (P <sub>diss</sub> ) at 85°C	1.2 W
Thermal Resistance	47°C/W
Operating Temperature (Ta)	-55°C to MTTF Graph
Storage Temperature (T <sub>stg</sub> )	-65°C to +165°C
Mounting Temperature	See solder reflow profile
ESD Min. - Machine Model (MM)	Class A
ESD Min. - Human Body Model (HBM)	Class 1A
MSL Level	MSL1

- Channel temperature directly affects a device's MTTF. Channel temperature should be kept as low as possible to maximize lifetime.
- For saturated performance it is recommended that the sum of  $(2 \cdot V_{dd} + \text{abs}(V_{gg})) < 9V$

## Typical Performance Curves

**XB1014-QT: Small Signal Gain (S21)**  
Vd = 4V, Id1 = Id2 = 62.5 mA, Id3 = 125 mA

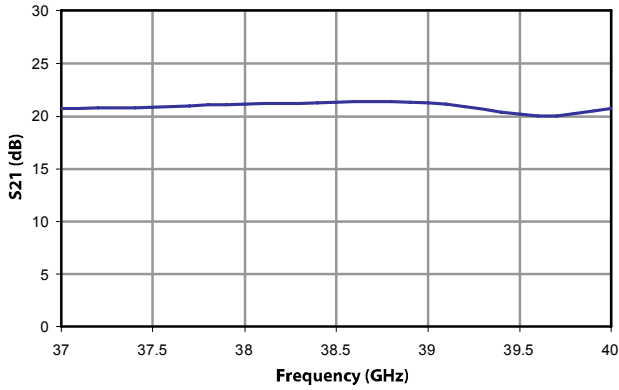

**XB1014-QT: Input Return Loss (S11)**  
Vd = 4V, Id1 = Id2 = 62.5 mA, Id3 = 125 mA

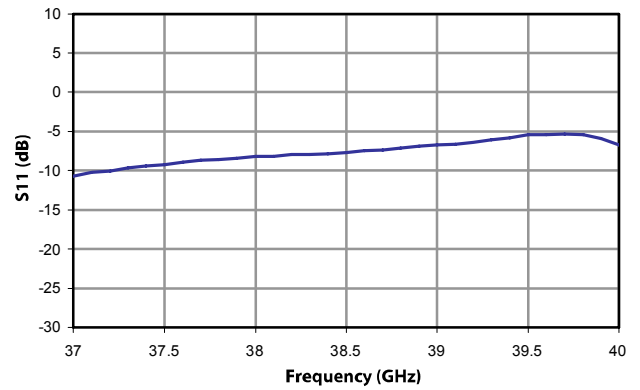

**XB1014-QT: Output Return Loss (S22)**  
Vd = 4V, Id1 = Id2 = 62.5 mA, Id3 = 125 mA

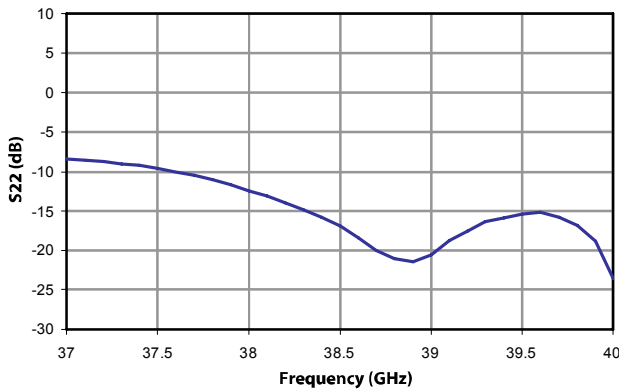

**XB1014-QT: Reverse Isolation (S12)**  
Vd = 4V, Id1 = Id2 = 62.5 mA, Id3 = 125 mA

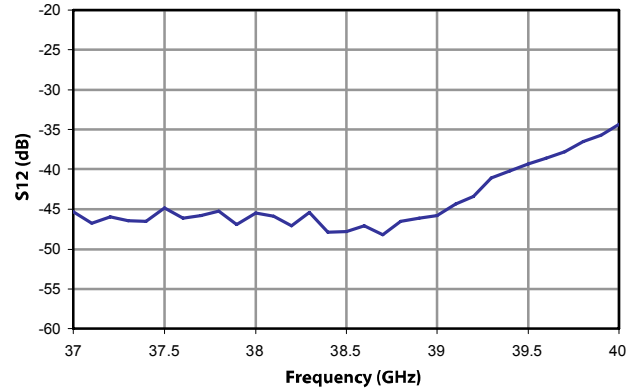

**XB1014-QT: OIP3 vs Freq**  
Psc1 = +5dBm; Vd1,2,3 = 4.0V, Id1 = Id2 = 62.5mA, Id3 = 125mA

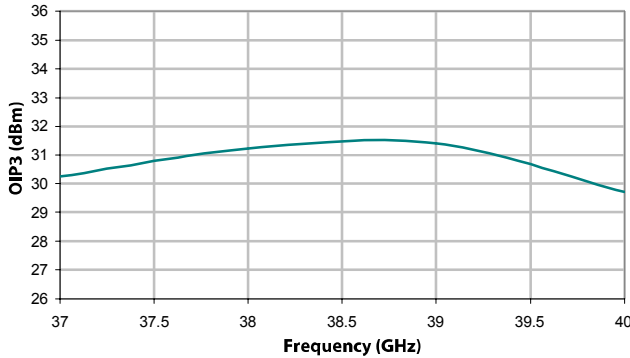

**XB1014-QT: C/I3 vs Freq**  
Psc1 = +5dBm; Vd1,2,3 = 4.0V, Id1 = Id2 = 62.5mA, Id3 = 125mA

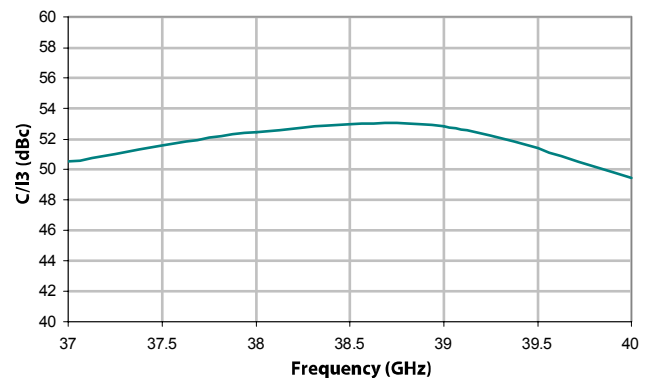

## Typical Performance Curves (cont.)

**XB1014-QT: P1dB vs Freq**  
Vd1,2,3=4.0V, Id1=Id2=62.5mA, Id3=125mA

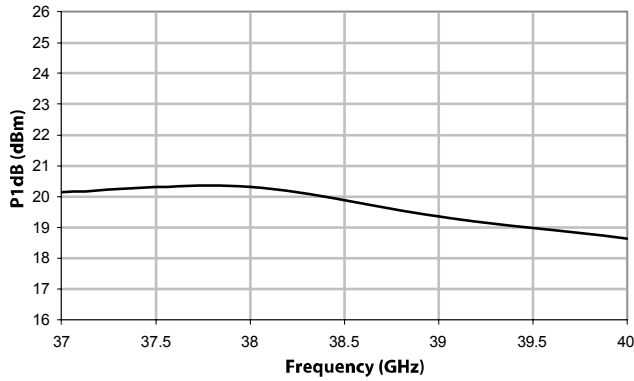

**XB1014-QT: Psat vs Freq**  
Vd1,2,3=4.0V, Id1=Id2=62.5mA, Id3=125mA

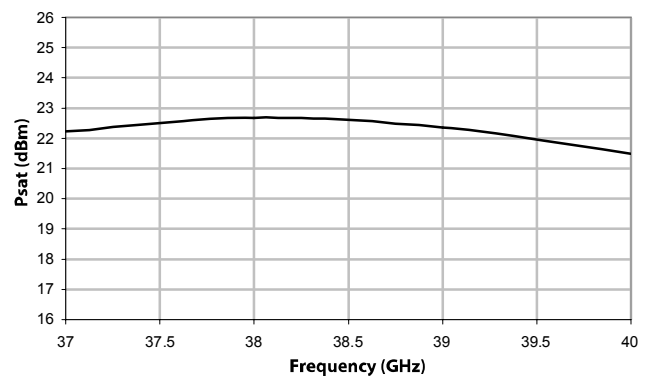

## MTTF

**XB1014-QT: MTTF hours vs. Package Base Temperature**  
Vd1,2,3=4V; Id1=Id2=62.5mA, Id3=125mA

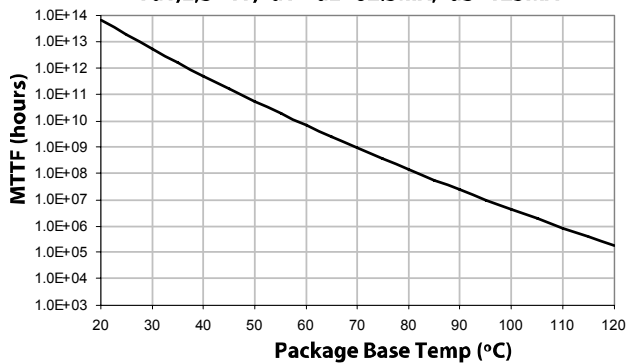

**XB1014-QT: Tch (max) vs. Package Base Temperature**  
Vd1,2,3=4V; Id1=Id2=62.5mA, Id3=125mA

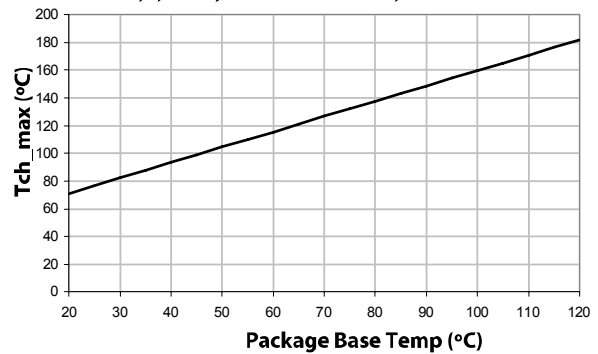

**XB1014-QT: Operating Power De-rating Curve (continuous)**

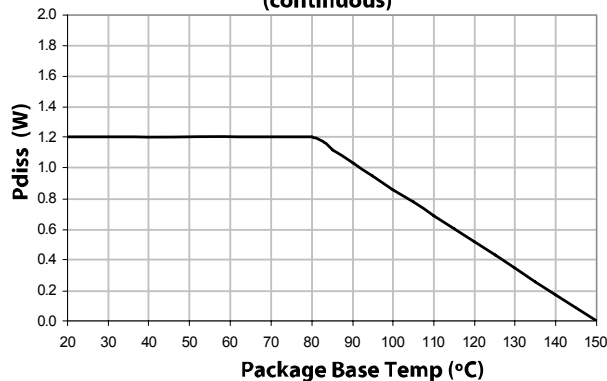

**App Note [1] Biasing** - It is recommended to bias the amplifier with  $V_d=4.0$  V and  $I_{dTOTAL}=250$  mA. It is also recommended to use active biasing to keep the currents constant as the RF power and temperature vary; this gives the most reproducible results. Depending on the supply voltage available and the power dissipation constraints, the bias circuit may be a single transistor or a low power operational amplifier, with a low value resistor in series with the drain supply used to sense the current. The gate of the pHEMT is controlled to maintain correct drain current and thus drain voltage. The typical gate voltage needed to do this is  $-0.3$  V. Typically the gate is protected with Silicon diodes to limit the applied voltage. Also, make sure to sequence the applied voltage to ensure negative gate bias is available before applying the positive drain supply.

**App Note [2] Bias Arrangement** - Each DC pin ( $V_d$  and  $V_g$ ) needs to have DC bypass capacitance (100pF/10nF/1uF) as close to the package as possible.

## Typical Application

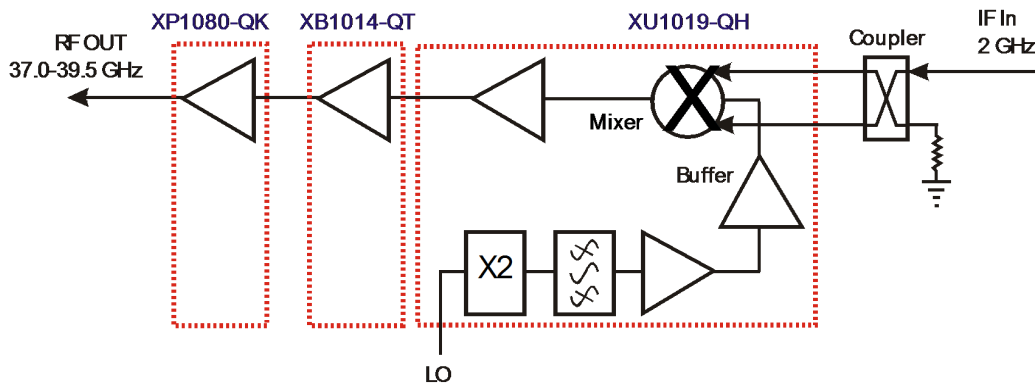

MMIC-based 37.0-40.0 GHz Transmitter Block Diagram

Buffer Amplifier  
37.0 - 40.0 GHz

Rev. V3

Lead-Free 3 mm 16-Lead PQFN<sup>†</sup>

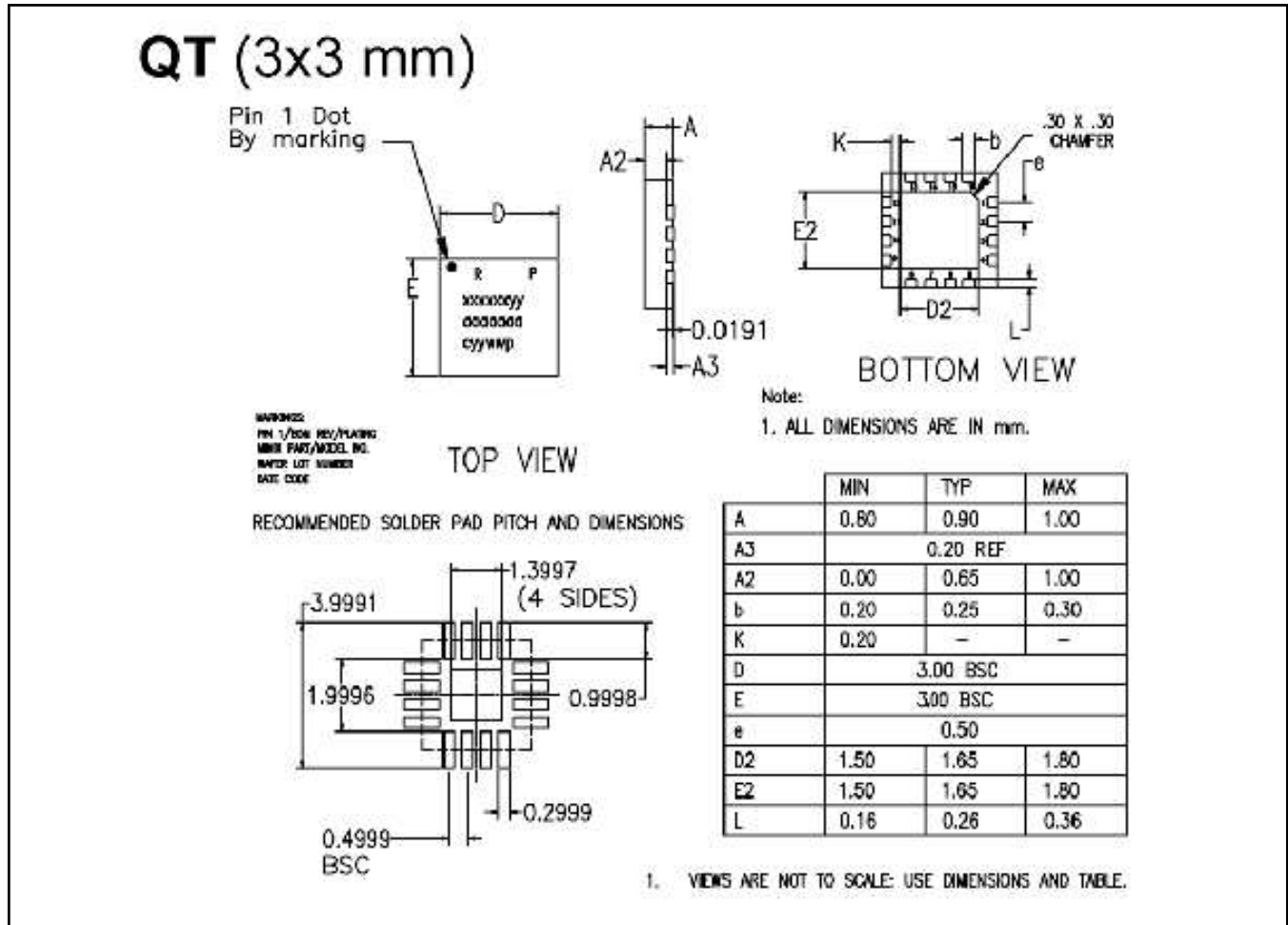

<sup>†</sup> Reference Application Note S2083 for lead-free solder reflow recommendations.  
Plating is 100% matte tin over copper.

## Handling Procedures

Please observe the following precautions to avoid damage:

## Static Sensitivity

Gallium Arsenide Integrated Circuits are sensitive to electrostatic discharge (ESD) and can be damaged by static electricity. Proper ESD control techniques should be used when handling these devices.

M/A-COM Technology Solutions Inc. All rights reserved.

Information in this document is provided in connection with M/A-COM Technology Solutions Inc ("MACOM") products. These materials are provided by MACOM as a service to its customers and may be used for informational purposes only. Except as provided in MACOM's Terms and Conditions of Sale for such products or in any separate agreement related to this document, MACOM assumes no liability whatsoever. MACOM assumes no responsibility for errors or omissions in these materials. MACOM may make changes to specifications and product descriptions at any time, without notice. MACOM makes no commitment to update the information and shall have no responsibility whatsoever for conflicts or incompatibilities arising from future changes to its specifications and product descriptions. No license, express or implied, by estoppel or otherwise, to any intellectual property rights is granted by this document.

THESE MATERIALS ARE PROVIDED "AS IS" WITHOUT WARRANTY OF ANY KIND, EITHER EXPRESS OR IMPLIED, RELATING TO SALE AND/OR USE OF MACOM PRODUCTS INCLUDING LIABILITY OR WARRANTIES RELATING TO FITNESS FOR A PARTICULAR PURPOSE, CONSEQUENTIAL OR INCIDENTAL DAMAGES, MERCHANTABILITY, OR INFRINGEMENT OF ANY PATENT, COPYRIGHT OR OTHER INTELLECTUAL PROPERTY RIGHT. MACOM FURTHER DOES NOT WARRANT THE ACCURACY OR COMPLETENESS OF THE INFORMATION, TEXT, GRAPHICS OR OTHER ITEMS CONTAINED WITHIN THESE MATERIALS. MACOM SHALL NOT BE LIABLE FOR ANY SPECIAL, INDIRECT, INCIDENTAL, OR CONSEQUENTIAL DAMAGES, INCLUDING WITHOUT LIMITATION, LOST REVENUES OR LOST PROFITS, WHICH MAY RESULT FROM THE USE OF THESE MATERIALS.

MACOM products are not intended for use in medical, lifesaving or life sustaining applications. MACOM customers using or selling MACOM products for use in such applications do so at their own risk and agree to fully indemnify MACOM for any damages resulting from such improper use or sale.