



Chipsmall Limited consists of a professional team with an average of over 10 year of expertise in the distribution of electronic components. Based in Hongkong, we have already established firm and mutual-benefit business relationships with customers from,Europe,America and south Asia,supplying obsolete and hard-to-find components to meet their specific needs.

With the principle of “Quality Parts,Customers Priority,Honest Operation,and Considerate Service”,our business mainly focus on the distribution of electronic components. Line cards we deal with include Microchip,ALPS,ROHM,Xilinx,Pulse,ON,Everlight and Freescale. Main products comprise IC,Modules,Potentiometer,IC Socket,Relay,Connector.Our parts cover such applications as commercial,industrial, and automotives areas.

We are looking forward to setting up business relationship with you and hope to provide you with the best service and solution. Let us make a better world for our industry!



## Contact us

Tel: +86-755-8981 8866 Fax: +86-755-8427 6832

Email & Skype: info@chipsmall.com Web: www.chipsmall.com

Address: A1208, Overseas Decoration Building, #122 Zhenhua RD., Futian, Shenzhen, China



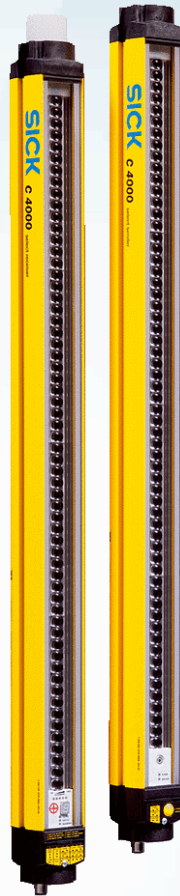

XC40E-0903A0A0CBA0

C4000 Select

SAFETY LIGHT CURTAINS

**SICK**  
Sensor Intelligence.

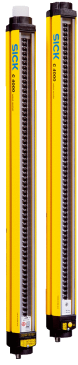

### Ordering information

Type	Part no.
XC40E-0903A0A0CBA0	1204159

Other models and accessories → [www.sick.com/C4000\\_Select](http://www.sick.com/C4000_Select)



### Detailed technical data

#### Features

<b>Protective field height</b>	900 mm
<b>Scanning range</b>	0 m ... 19 m
<b>Resolution</b>	30 mm
<b>Response time</b>	≤ 12 ms <sup>1)</sup>
<b>Synchronization</b>	Optical synchronisation

<sup>1)</sup> Without beam coding, without blanking, no cascaded systems. Other response times see operating instructions.

#### Safety-related parameters

<b>Type</b>	Type 4 (IEC 61496-1)
<b>Safety integrity level</b>	SIL3 (IEC 61508) SILCL3 (EN 62061)
<b>Category</b>	Category 4 (EN ISO 13849)
<b>Performance level</b>	PL e (EN ISO 13849)
<b>PFH<sub>D</sub> (mean probability of a dangerous failure per hour)</b>	3.2 x 10 <sup>-8</sup> (EN ISO 13849)
<b>T<sub>M</sub> (mission time)</b>	20 years (EN ISO 13849)
<b>Safe state in the event of a fault</b>	At least one OSSD is in the OFF state.

#### Functions

	Functions	Delivery status
<b>Beam coding</b>	✓	Uncoded
<b>Configurable scanning range</b>	✓	

#### Interfaces

<b>System connection</b>	Connection type	Male connector M12, 5-pin
--------------------------	-----------------	---------------------------

<sup>1)</sup> Depending on load, power supply and wire cross-section. The technical specifications must be observed.

<sup>2)</sup> For additional information on Flexi Soft -> [www.sick.com/Flexi\\_Soft](http://www.sick.com/Flexi_Soft).

Permitted cable length	≤ 30 m <sup>1)</sup>
<b>Extension connection</b>	
Connection type	Female connector M12, 5-pin
Position of extension connection	At bottom end cap
Permitted cable length	≤ 10 m
<b>Configuration method</b>	DIP switch
<b>Display elements</b>	7-segment display
<b>Fieldbus, industrial network</b>	
Integration via Flexi Soft safety controller	CANopen, DeviceNet™, EtherCAT®, EtherNet/IP™, Modbus TCP, PROFIBUS DP, PROFINET <sup>2)</sup>

<sup>1)</sup> Depending on load, power supply and wire cross-section. The technical specifications must be observed.

<sup>2)</sup> For additional information on Flexi Soft -> [www.sick.com/Flexi\\_Soft](http://www.sick.com/Flexi_Soft).

### Electrical data

<b>Protection class</b>	III (EN 50178)
<b>Power consumption</b>	≤ 8.1 W
<b>Output signal switching devices (OSSDs)</b>	
Type of output	2 PNP semiconductors, short-circuit protected, cross-circuit monitored
ON state, switching voltage HIGH	24 V DC ( $V_S - 2.25 \text{ V DC} \dots V_S$ )
OFF state, switching voltage LOW	2 V DC
Current-carrying capacity per OSSD	≤ 500 mA
Switch off time	≥ 100 ms

### Mechanical data

<b>Housing material</b>	Aluminum alloy ALMGSI 0.5
-------------------------	---------------------------

### Ambient data

<b>Enclosure rating</b>	IP65 (EN 60529)
<b>Ambient operating temperature</b>	0 °C ... +55 °C
<b>Storage temperature</b>	-25 °C ... +70 °C
<b>Air humidity</b>	15 % ... 95 %, Non-condensing
<b>Vibration resistance</b>	5 g, 10 Hz ... 55 Hz (EN 60068-2-6)
<b>Shock resistance</b>	10 g, 16 ms (EN 60068-2-27)

### Classifications

<b>ECl@ss 5.0</b>	27272704
<b>ECl@ss 5.1.4</b>	27272704
<b>ECl@ss 6.0</b>	27272704
<b>ECl@ss 6.2</b>	27272704
<b>ECl@ss 7.0</b>	27272704
<b>ECl@ss 8.0</b>	27272704
<b>ECl@ss 8.1</b>	27272704
<b>ECl@ss 9.0</b>	27272704
<b>ETIM 5.0</b>	EC002549
<b>ETIM 6.0</b>	EC002549
<b>UNSPSC 16.0901</b>	46171620



### Dimensional drawing (Dimensions in mm (inch))



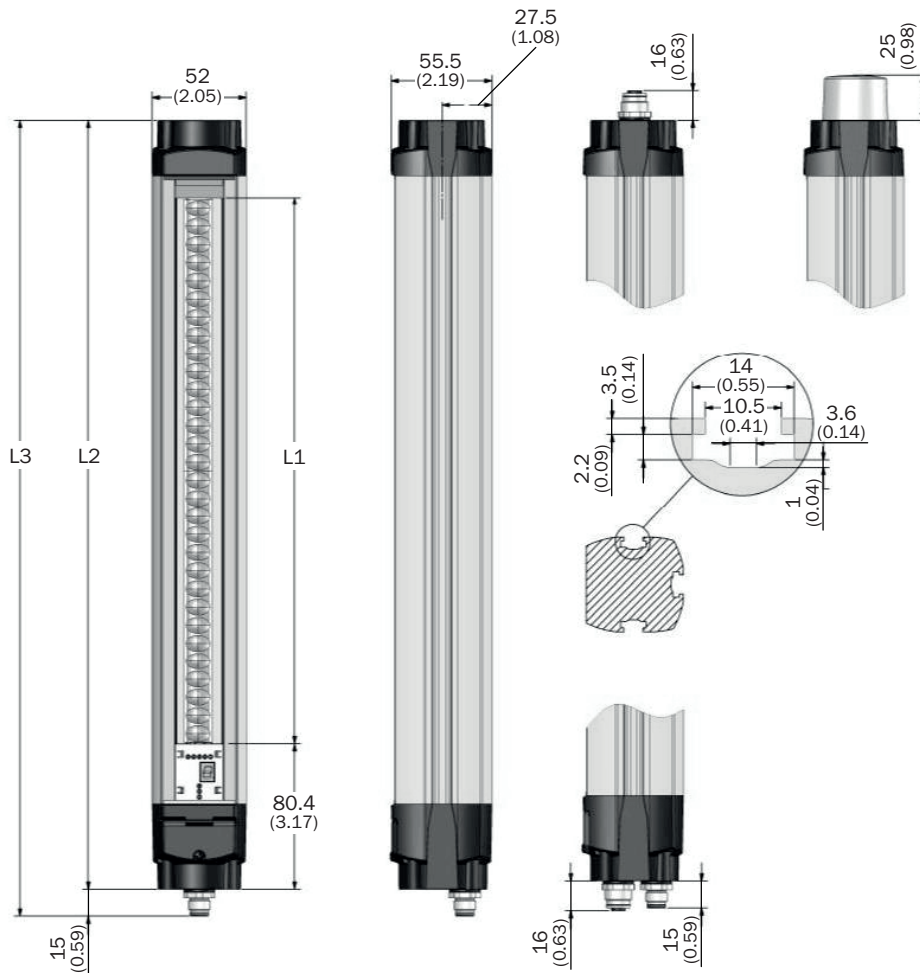

Receiver



Protective field height S	L1	L2	L3
300 (11.81)	302 (11.89)	425 (16.73)	440 (17.32)
450 (17.72)	452 (17.80)	575 (22.64)	590 (23.23)
600 (23.62)	602 (23.70)	725 (28.54)	740 (29.13)
750 (29.53)	752 (29.61)	875 (34.45)	890 (35.04)
900 (35.43)	902 (35.51)	1,025 (40.35)	1,040 (40.94)
1,050 (41.34)	1,052 (41.42)	1,175 (46.26)	1,190 (46.85)
1,200 (47.24)	1,202 (47.32)	1,325 (52.17)	1,340 (52.76)
1,350 (53.15)	1,352 (53.23)	1,475 (58.07)	1,490 (58.66)
1,500 (59.06)	1,502 (59.13)	1,625 (63.98)	1,640 (64.57)
1,650 (64.96)	1,652 (65.04)	1,775 (69.88)	1,790 (70.47)
1,800 (70.87)	1,802 (70.94)	1,925 (75.79)	1,940 (76.38)

**Recommended accessories**

Other models and accessories → [www.sick.com/C4000\\_Select](http://www.sick.com/C4000_Select)

	<b>Brief description</b>	<b>Type</b>	<b>Part no.</b>
<b>Mounting brackets and plates</b>			
	4 pieces, Mounting kit 1, mounting bracket, rigid, L-shaped, including fixing screws and washers	BEF-3WNGBAST4	7021352
<b>Terminal and alignment brackets</b>			
	4 pieces, Mounting kit 6, side bracket, rotatable, Zinc diecast	BEF-1SHABAZN4	2019506
	4 pieces, Mounting kit 12, rotatable, swivel mount	BEF-2SMGEAKU4	2030510
<b>Plug connectors and cables</b>			
	Head A: female connector, M12, 5-pin, straight, A-coded Head B: male connector, M12, 5-pin, straight, A-coded Cable: Sensor/actuator cable, PUR, halogen-free, unshielded, 2 m	YF2A15-020UB5M2A15	2096009
<b>Alignment aids</b>			
	Laser alignment aid for various sensors, laser class 2 (IEC 60825). Do not look into the beam!	AR60	1015741

## SICK AT A GLANCE

SICK is one of the leading manufacturers of intelligent sensors and sensor solutions for industrial applications. A unique range of products and services creates the perfect basis for controlling processes securely and efficiently, protecting individuals from accidents and preventing damage to the environment.

We have extensive experience in a wide range of industries and understand their processes and requirements. With intelligent sensors, we can deliver exactly what our customers need. In application centers in Europe, Asia and North America, system solutions are tested and optimized in accordance with customer specifications. All this makes us a reliable supplier and development partner.

Comprehensive services complete our offering: SICK LifeTime Services provide support throughout the machine life cycle and ensure safety and productivity.

For us, that is “Sensor Intelligence.”

## WORLDWIDE PRESENCE:

Contacts and other locations [www.sick.com](http://www.sick.com)