



Chipsmall Limited consists of a professional team with an average of over 10 year of expertise in the distribution of electronic components. Based in Hongkong, we have already established firm and mutual-benefit business relationships with customers from,Europe,America and south Asia,supplying obsolete and hard-to-find components to meet their specific needs.

With the principle of “Quality Parts,Customers Priority,Honest Operation,and Considerate Service”,our business mainly focus on the distribution of electronic components. Line cards we deal with include Microchip,ALPS,ROHM,Xilinx,Pulse,ON,Everlight and Freescale. Main products comprise IC,Modules,Potentiometer,IC Socket,Relay,Connector.Our parts cover such applications as commercial,industrial, and automotives areas.

We are looking forward to setting up business relationship with you and hope to provide you with the best service and solution. Let us make a better world for our industry!



## Contact us

Tel: +86-755-8981 8866 Fax: +86-755-8427 6832

Email & Skype: info@chipsmall.com Web: www.chipsmall.com

Address: A1208, Overseas Decoration Building, #122 Zhenhua RD., Futian, Shenzhen, China



## General Description

Virtex<sup>®</sup>-6 CXT FPGAs provide designers needing power-optimized 3.75 Gb/s transceiver performance with an optimized ratio of built-in system-level blocks. These include 36 Kb block RAM/FIFOs, up to 15 Mb of block RAM, up to 768 DSP48E1 slices, enhanced mixed-mode clock management blocks, PCI Express<sup>®</sup> (GEN 1) compatible integrated blocks, a tri-mode Ethernet media access controller (MAC), up to 241K logic cells, and strong IP support. Using the third generation ASMBL<sup>™</sup> (Advanced Silicon Modular Block) column-based architecture, the Virtex-6 CXT family also contains SelectIO<sup>™</sup> technology with built-in digitally controlled impedance, ChipSync<sup>™</sup> source-synchronous interface blocks, enhanced mixed-mode clock management blocks, and advanced configuration options. Customers needing higher transceiver speeds, greater I/O performance, additional Ethernet MACs, or greater capacity should instead use the Virtex-6 LXT or SXT families. Built on a 40 nm state-of-the-art copper process technology, Virtex-6 CXT FPGAs are a programmable alternative to custom ASIC technology. Virtex-6 CXT FPGAs are the programmable silicon foundation for Targeted Design Platforms that deliver integrated software and hardware components to enable designers to focus on innovation as soon as their development cycle begins.

## Summary of Virtex-6 CXT FPGA Features

- Advanced, high-performance, FPGA Logic
  - Real 6-input look-up table (LUT) technology
  - Dual LUT5 (5-input LUT) option
  - LUT/dual flip-flop pair for applications requiring rich register mix
  - Improved routing efficiency
  - 64-bit (or 32 x 2-bit) distributed LUT RAM option
  - SRL32/dual SRL16 with registered outputs option
- Powerful mixed-mode clock managers (MMCM)
  - MMCM blocks provide zero-delay buffering, frequency synthesis, clock-phase shifting, input-jitter filtering, and phase-matched clock division
- 36-Kb block RAM/FIFOs
  - Dual-port RAM blocks
  - Programmable
    - Dual-port widths up to 36 bits
    - Simple dual-port widths up to 72 bits
  - Enhanced programmable FIFO logic
  - Built-in optional error-correction circuitry
  - Optionally use each block as two independent 18 Kb blocks
- High-performance parallel SelectIO technology
  - 1.2 to 2.5V I/O operation
  - Source-synchronous interfacing using ChipSync<sup>™</sup> technology
  - Digitally controlled impedance (DCI) active termination
  - Flexible fine-grained I/O banking
  - High-speed memory interface support with integrated write-leveling capability
- Advanced DSP48E1 slices
  - 25 x 18, two's complement multiplier/accumulator
  - Optional pipelining
  - New optional pre-adder to assist filtering applications
  - Optional bitwise logic functionality
  - Dedicated cascade connections
- Flexible configuration options
  - SPI and Parallel Flash interface
  - Multi-bitstream support with dedicated fallback reconfiguration logic
  - Automatic bus width detection
- Integrated interface blocks for PCI Express designs
  - Compliant to the PCI Express Base Specification 2.0
  - Gen1 Endpoint (2.5 Gb/s) support with GTX transceivers
  - x1, x2, x4, or x8 lane support per block
  - One virtual channel, eight traffic classes
- GTX transceivers: 150 Mb/s to 3.75 Gb/s
- Integrated 10/100/1000 Mb/s Ethernet MAC block
  - Supports 100BASE-X PCS/PMA and SGMII using GTX transceivers
  - Supports MII, GMII, and RGMII using SelectIO technology resources
- 40 nm copper CMOS process technology
- 1.0V core voltage
- Two speed grades (-1 and -2)
- Two temperature grades (commercial and industrial)
- High signal-integrity flip-chip packaging available in standard or Pb-free package options
- Compatibility across sub-families: CXT, LXT, and SXT devices are footprint compatible in the same package



## Virtex-6 CXT FPGA Feature Summary

Table 1: Virtex-6 CXT FPGA Feature Summary by Device

Device	Logic Cells	Configurable Logic Blocks (CLBs)		DSP48E1 Slices <sup>(2)</sup>	Block RAM Blocks			MMCMs <sup>(4)</sup>	Interface Blocks for PCI Express	Ethernet MACs <sup>(5)</sup>	Maximum GTX Transceivers	Total I/O Banks <sup>(6)</sup>	Max User I/O <sup>(7)</sup>
		Slices <sup>(1)</sup>	Max Distributed RAM (Kb)		18 Kb <sup>(3)</sup>	36 Kb	Max (Kb)						
XC6VCX75T	74,496	11,640	1,045	288	312	156	5,616	6	1	1	12	9	360
XC6VCX130T	128,000	20,000	1,740	480	528	264	9,504	10	2	1	16	15	600
XC6VCX195T	199,680	31,200	3,040	640	688	344	12,384	10	2	1	16	15	600
XC6VCX240T	241,152	37,680	3,650	768	832	416	14,976	12	2	1	16	18	600

**Notes:**

1. Each Virtex-6 CXT FPGA slice contains four LUTs and eight flip-flops, only some slices can use their LUTs as distributed RAM or SRLs.
2. Each DSP48E1 slice contains a 25 x 18 multiplier, an adder, and an accumulator.
3. Block RAMs are fundamentally 36 Kbits in size. Each block can also be used as two independent 18 Kb blocks.
4. Each CMT contains two mixed-mode clock managers (MMCM).
5. This table lists individual Ethernet MACs per device.
6. Does not include configuration Bank 0.
7. This number does not include GTX transceivers.

## Virtex-6 CXT FPGA Device-Package Combinations and Maximum I/Os

Virtex-6 CXT FPGA package combinations with the maximum available I/Os per package are shown in Table 2.

Table 2: Virtex-6 CXT FPGA Device-Package Combinations and Maximum Available I/Os

Package	FF484 FFG484		FF784 FFG784		FF1156 FFG1156	
	Size (mm)		Size (mm)		Size (mm)	
Device	GTs	I/O	GTs	I/O	GTs	I/O
XC6VCX75T	8 GTXs	240	12 GTXs	360		
XC6VCX130T	8 GTXs	240	12 GTXs	400	16 GTXs	600
XC6VCX195T			12 GTXs	400	16 GTXs	600
XC6VCX240T			12 GTXs	400	16 GTXs	600

**Notes:**

1. Flip-chip packages are also available in Pb-Free versions (FFG).

## Virtex-6 CXT FPGA Ordering Information

The Virtex-6 CXT FPGA ordering information shown in Figure 1 applies to all packages including Pb-Free.

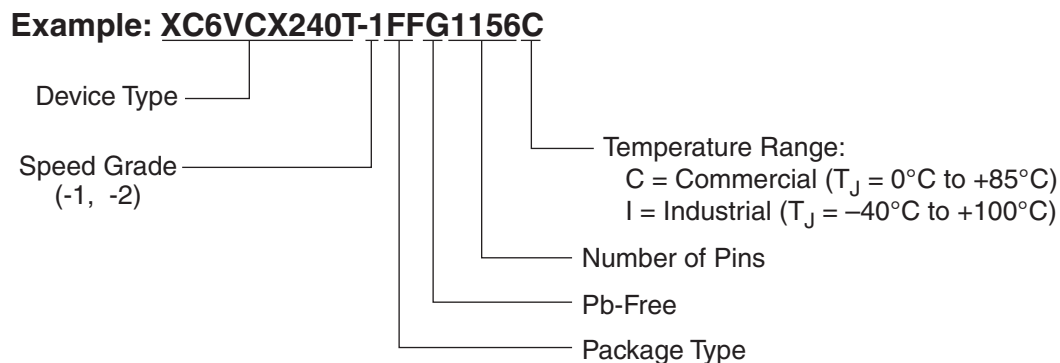

DS153\_01\_062109

Figure 1: Virtex-6 CXT FPGA Ordering Information

## Virtex-6 CXT FPGA Documentation

In addition to the data sheet information found herein, complete and up-to-date documentation of the Virtex-6 family of FPGAs is available on the Xilinx website and available for download:

### ***Virtex-6 FPGA Configuration Guide*** ([UG360](#))

This all-encompassing configuration guide includes chapters on configuration interfaces (serial and parallel), multi-bitstream management, bitstream encryption, boundary-scan and JTAG configuration, and reconfiguration techniques.

### ***Virtex-6 FPGA SelectIO Resources User Guide*** ([UG361](#))

This guide describes the SelectIO™ resources available in all the Virtex-6 CXT devices.

### ***Virtex-6 FPGA Clocking Resources User Guide*** ([UG362](#))

This guide describes the clocking resources available in all the Virtex-6 CXT devices, including the MMCM and clock buffers.

### ***Virtex-6 FPGA Memory Resources User Guide*** ([UG363](#))

This guide describes the Virtex-6 CXT device block RAM and FIFO capabilities.

### ***Virtex-6 FPGA CLB User Guide*** ([UG364](#))

This guide describes the capabilities of the configurable logic blocks (CLB) available in all Virtex-6 CXT devices.

### ***Virtex-6 FPGA DSP48E1 Slice User Guide*** ([UG369](#))

This guide describes the architecture of the DSP48E1 slice in Virtex-6 CXT FPGAs and provides configuration examples.

### ***Virtex-6 FPGA GTX Transceivers User Guide*** ([UG366](#))

This guide describes the GTX transceivers available in all the Virtex-6 CXT FPGAs.

### ***Virtex-6 FPGA Tri-Mode Ethernet MAC User Guide*** ([UG368](#))

This guide describes the dedicated tri-mode Ethernet media access controller (TEMAC) available in all the Virtex-6 CXT FPGAs.

### ***Virtex-6 FPGA Data Sheet: DC and Switching Characteristics*** ([DS152](#))

Reference this data sheet when considering device migration to the Virtex-6 LXT and SXT families. It contains the DC and Switching Characteristic specifications specifically for the Virtex-6 LXT and SXT families.

### ***Virtex-6 FPGA Packaging and Pinout Specifications*** ([UG365](#))

These specifications includes the tables for device/package combinations and maximum I/Os, pin definitions, pinout tables, pinout diagrams, mechanical drawings, and thermal specifications of the Virtex-6 LXT and SXT families. Reference these specifications when considering device migration to the Virtex-6 LXT and SXT families.

## Configuration Bitstream Overview for CXT Devices

This section contains two tables similar to those in the *Virtex-6 FPGA Configuration Guide* only updated for the CXT family. The Virtex-6 CXT FPGA bitstream contains commands to the FPGA configuration logic as well as configuration data. [Table 3](#) gives a typical bitstream length and [Table 4](#) gives the specific device ID codes for the Virtex-6 CXT devices.

**Table 3: Virtex-6 CXT FPGA Bitstream Length**

Device	Total Number of Configuration Bits
XC6VCX75T	26,239,328
XC6VCX130T	43,719,776
XC6VCX195T	61,552,736
XC6VCX240T	73,859,552

**Table 4: Virtex-6 CXT FPGA Device ID Codes**

Device	ID Code (Hex)
XC6VCX75T	0x042C4093
XC6VCX130T	0x042CA093
XC6VCX195T	0x042CC093
XC6VCX240T	0x042D0093

## CLB Overview for CXT Devices

Table 5, updated specifically for the CXT family from a similar table in the *Virtex-6 FPGA CLB User Guide*, shows the available resources in all Virtex-6 CXT FPGA CLBs.

Table 5: Virtex-6 CXT FPGA Logic Resources Available in All CLBs

Device	Total Slices	SLICELs	SLICEMs	Number of 6-Input LUTs	Maximum Distributed RAM (Kb)	Shift Register (Kb)	Number of Flip-Flops
XC6VCX75T	11,640	7,460	4,180	46,560	1045	522.5	93,120
XC6VCX130T	20,000	13,040	6,960	80,000	1740	870	160,000
XC6VCX195T	31,200	19,040	12,160	124,800	3140	1570	249,600
XC6VCX240T	37,680	23,080	14,600	150,720	3770	1885	301,440

## Regional Clock Management for CXT Devices

Table 6, updated from the *Virtex-6 FPGA Clocking Resources User Guide* specifically for the CXT family, shows the number of clock regions in all Virtex-6 CXT FPGA CLBs.

Table 6: Virtex-6 CXT FPGA Clock Regions

Device	Number of Clock Regions
XC6VCX75T	6
XC6VCX130T	10
XC6VCX195T	10
XC6VCX240T	12

## CXT Packaging Specifications

Table 7, updated from the *Virtex-6 FPGA Packaging and Pinout Specifications* specifically for the CXT family, shows the number of GTX transceiver I/O channels. Table 8 shows the number of available I/Os and the number of differential I/O pairs for each Virtex-6 device/package combination.

Table 7: Number of Serial Transceivers (GTs) I/O Channels/Device

I/O Channels	Device			
	CX75T <sup>(1)</sup>	CX130T <sup>(2)</sup>	CX195T <sup>(3)</sup>	CX240T <sup>(4)</sup>
MGTRXP	8 or 12	8, 12, or 16	12 or 16	12 or 16
MGTRXN	8 or 12	8, 12, or 16	12 or 16	12 or 16
MGTTXP	8 or 12	8, 12, or 16	12 or 16	12 or 16
MGTTXN	8 or 12	8, 12, or 16	12 or 16	12 or 16

### Notes:

1. The XC6VCX75T has 8 GTX I/O channels in the FF484/FFG484 package and 12 GTX I/O channels in the FF784/FFG784 package.
2. The XC6VCX130T has 8 GTX I/O channels in the FF484/FFG484 package, 12 GTX I/O channels in the FF784/FFG784 package, and 16 GTX I/O channels in the FF1156/FFG1156 package.
3. The XC6VCX195T has 12 GTX I/O channels in the FF784/FFG784 package and 16 GTX I/O channels in the FF1156/FFG1156 package.
4. The XC6VCX240T has 12 GTX I/O channels in the FF784/FFG784 package and 16 GTX I/O channels in the FF1156/FFG1156 package.

Table 8: Available I/O Pin/Device/Package Combinations

Virtex-6 CXT Device	User I/O Pins	Virtex-6 CXT FPGA Package		
		FF484	FF784	FF1156
XC6VCX75T	Available User I/Os	240	360	–
	Differential I/O Pairs	120	180	–
XC6VCX130T	Available User I/Os	240	400	600
	Differential I/O Pairs	120	200	300
XC6VCX195T	Available User I/Os	–	400	600
	Differential I/O Pairs	–	200	300
XC6VCX240T	Available User I/Os	–	400	600
	Differential I/O Pairs	–	200	300

## GTX Transceivers in CXT Devices

CXT devices have between 8 to 16 gigabit transceiver circuits. Each GTX transceiver is a combined transmitter and receiver capable of operating at a data rate between 480 Mb/s and 3.75 Gb/s. Lower data rates can be achieved using FPGA logic-based oversampling. The transmitter and receiver are independent circuits that use separate PLLs to multiply the reference frequency input by certain programmable numbers between 2 and 25, to become the bit-serial data clock. Each GTX transceiver has a large number of user-definable features and parameters. All of these can be defined during device configuration, and many can also be modified during operation.

## FF484 Package Placement Diagrams

Figure 2 and Figure 3 show the placement diagrams for the GTX transceivers in the FF484 package.

**Note:** Unbonded locations in the FF484 package are:

- CX75T: X0Y8, X0Y9, X0Y10, X0Y11
- CX130T: X0Y0, X0Y1, X0Y2, X0Y3, and X0Y12, X0Y13, X0Y14, X0Y15

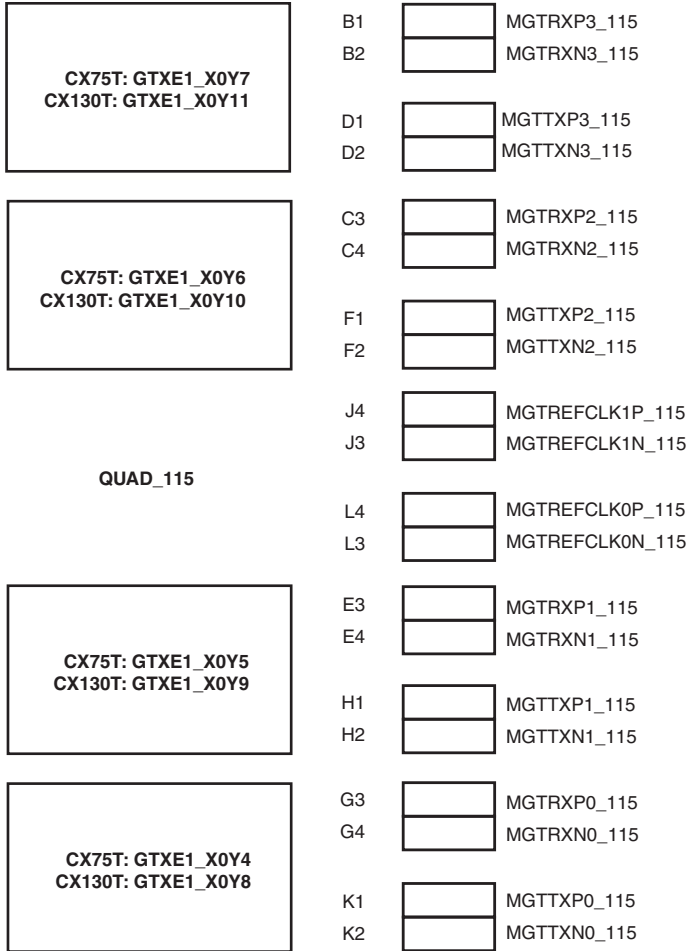

ds153\_02\_041510

Figure 2: Placement Diagram for the FF484 Package (1 of 2)

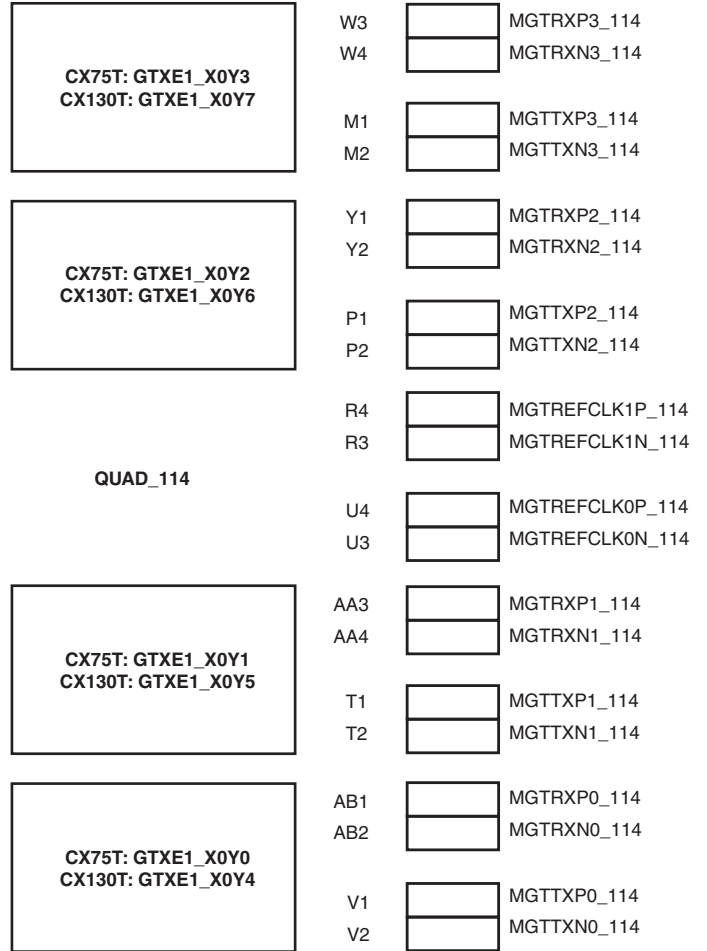

ds153\_03\_041510

Figure 3: Placement Diagram for the FF484 Package (2 of 2)

### FF784 Package Placement Diagrams

Figure 4 through Figure 6 show the placement diagrams for the GTX transceivers in the FF784 package.

**Note:** Unbonded locations in the FF784 package are:

- CX130T: X0Y0, X0Y1, X0Y2, X0Y3
- CX195T: X0Y0, X0Y1, X0Y2, X0Y3
- CX240T: X0Y0, X0Y1, X0Y2, X0Y3

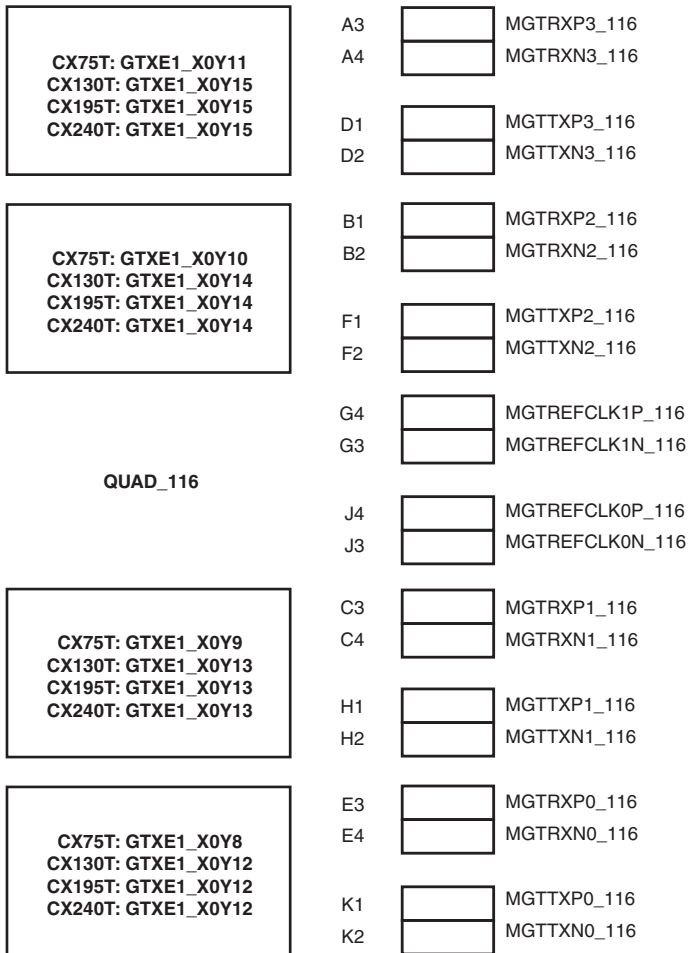

ds153\_04\_041510

Figure 4: Placement Diagram for the FF784 Package (1 of 3)

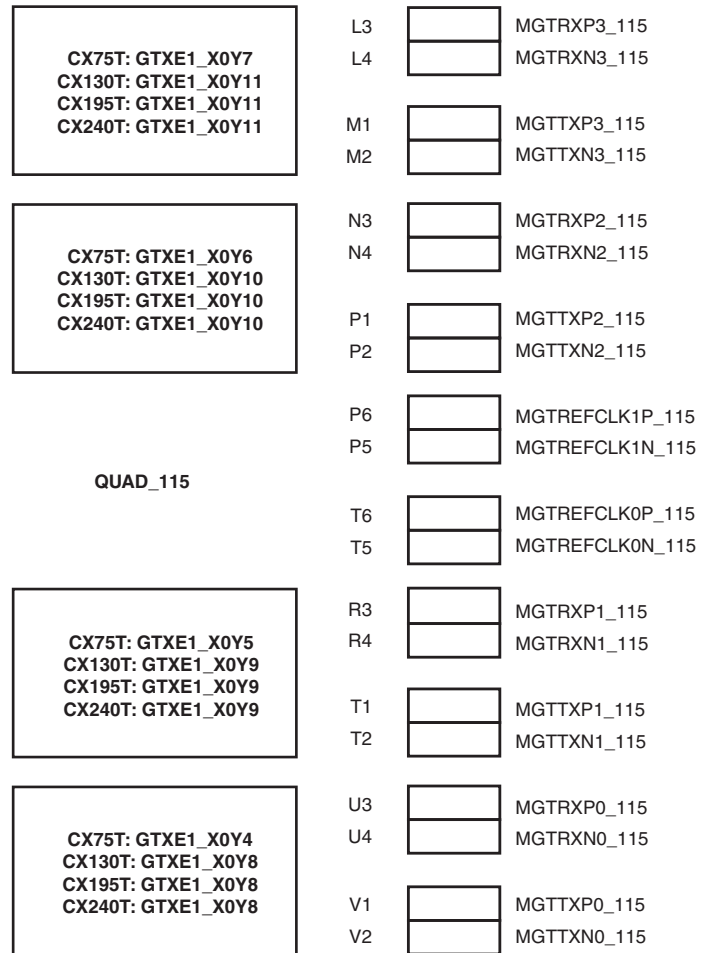

ds153\_05\_041510

Figure 5: Placement Diagram for the FF784 Package (2 of 3)



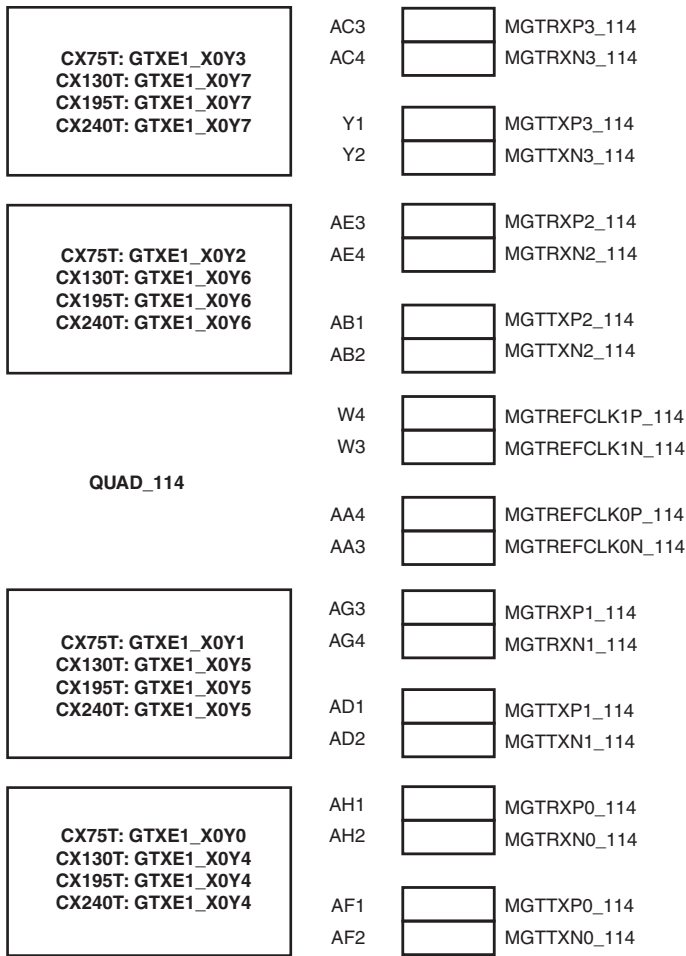

ds153\_06\_041510

Figure 6: Placement Diagram for the FF784 Package  
(3 of 3)

## FF1156 Package Placement Diagrams

Figure 7 through Figure 10 show the placement diagrams for the GTX transceivers in the FF1156 package.

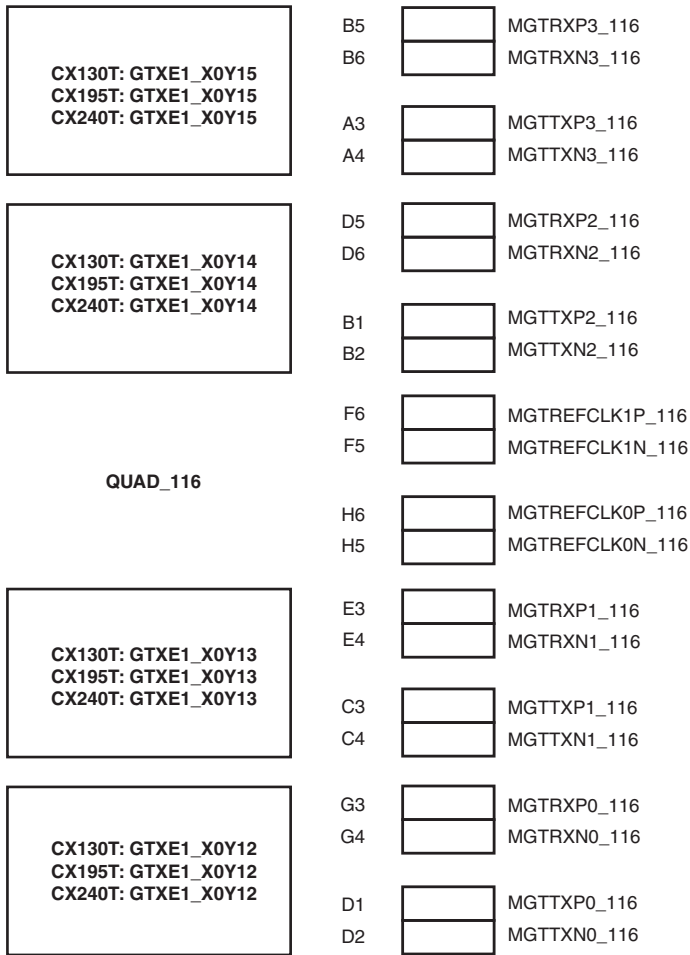

Figure 7: Placement Diagram for the FF1156 Package (1 of 4)

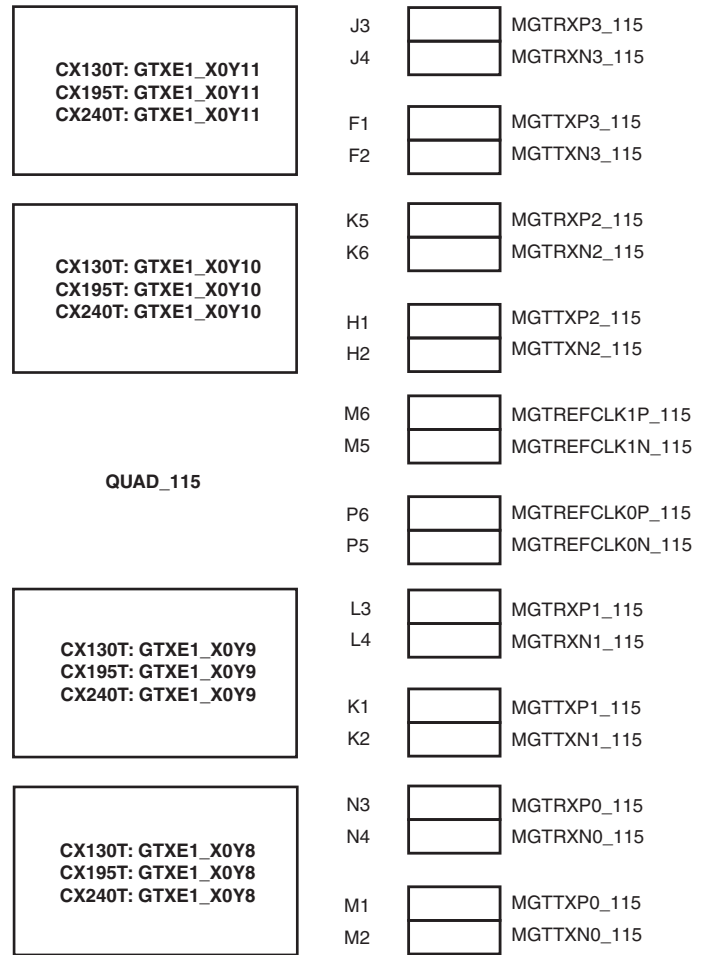

Figure 8: Placement Diagram for the FF1156 Package (2 of 4)

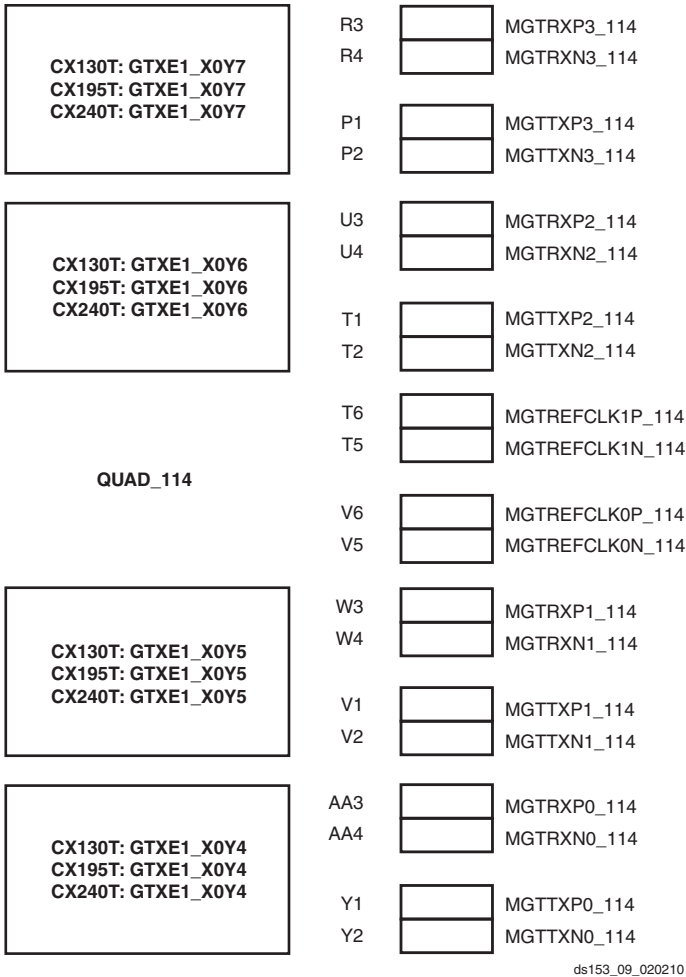

Figure 9: Placement Diagram for the FF1156 Package (3 of 4)

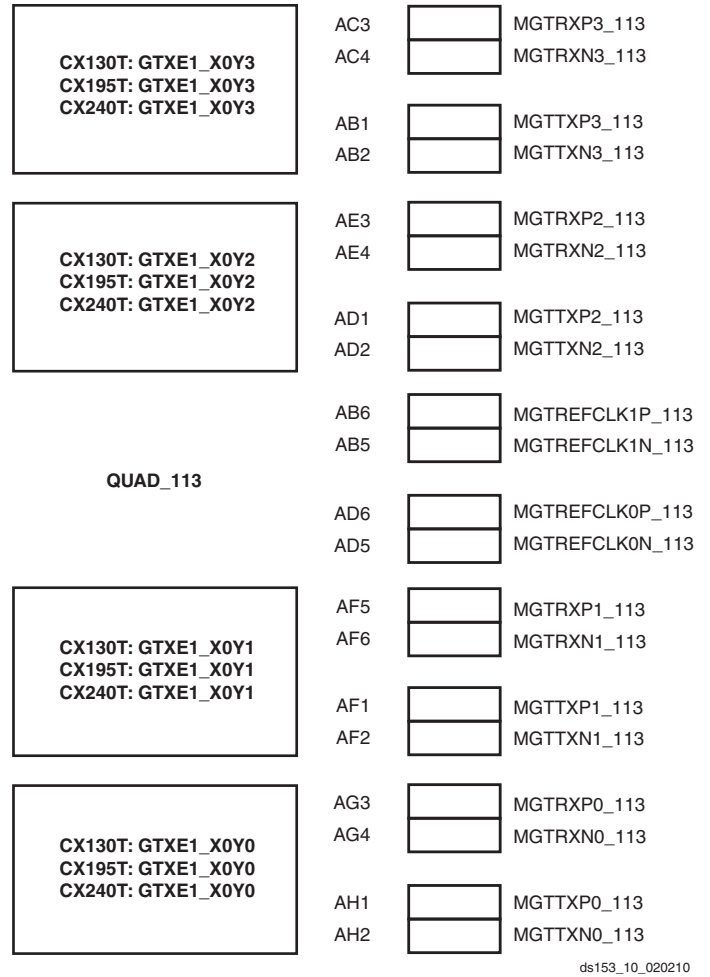

Figure 10: Placement Diagram for the FF1156 Package (4 of 4)

## Virtex-6 CXT FPGA Electrical Characteristics Introduction

Virtex-6 CXT FPGAs are available in -2 and -1 speed grades, with -2 having the highest performance. Virtex-6 CXT FPGA DC and AC characteristics are specified for both commercial and industrial grades. Except the operating temperature range or unless otherwise noted, all the DC and AC electrical parameters are the same for a particular speed grade (that is, the timing characteristics of a -1 speed grade industrial device are the same as for a -1 speed grade commercial device). However, only selected speed grades and/or devices might be available in the industrial range.

All supply voltage and junction temperature specifications are representative of worst-case conditions. The parameters included are common to popular designs and typical applications.

All specifications are subject to change without notice.

## Virtex-6 CXT FPGA DC Characteristics

Table 9: Absolute Maximum Ratings<sup>(1)</sup>

Symbol	Description		Units
V <sub>CCINT</sub>	Internal supply voltage relative to GND	-0.5 to 1.1	V
V <sub>CCAUX</sub>	Auxiliary supply voltage relative to GND	-0.5 to 3.0	V
V <sub>CCO</sub>	Output drivers supply voltage relative to GND	-0.5 to 3.0	V
V <sub>BATT</sub>	Key memory battery backup supply	-0.5 to 3.0	V
V <sub>FS</sub>	External voltage supply for eFUSE programming <sup>(2)</sup>	-0.5 to 3.0	V
V <sub>REF</sub>	Input reference voltage	-0.5 to 3.0	V
V <sub>IN</sub> <sup>(3)</sup>	2.5V or below I/O input voltage relative to GND <sup>(4)</sup> (user and dedicated I/Os)	-0.5 to V <sub>CCO</sub> + 0.5	V
V <sub>TS</sub>	Voltage applied to 3-state 2.5V or below output <sup>(4)</sup> (user and dedicated I/Os)	-0.5 to V <sub>CCO</sub> + 0.5	V
T <sub>STG</sub>	Storage temperature (ambient)	-65 to 150	°C
T <sub>SOL</sub>	Maximum soldering temperature <sup>(5)</sup>	+220	°C
T <sub>j</sub>	Maximum junction temperature <sup>(5)</sup>	+125	°C

### Notes:

1. Stresses beyond those listed under Absolute Maximum Ratings might cause permanent damage to the device. These are stress ratings only, and functional operation of the device at these or any other conditions beyond those listed under Operating Conditions is not implied. Exposure to Absolute Maximum Ratings conditions for extended periods of time might affect device reliability.
2. When not programming eFUSE, connect V<sub>FS</sub> to GND.
3. 2.5V I/O absolute maximum limit applied to DC and AC signals.
4. For I/O operation, refer to the *Virtex-6 FPGA SelectIO Resources User Guide*.
5. For soldering guidelines and thermal considerations, see *Virtex-6 FPGA Packaging and Pinout Specification*.

Table 10: Recommended Operating Conditions

Symbol	Description	Min	Max	Units
V <sub>CCINT</sub>	Internal supply voltage relative to GND, T <sub>j</sub> = 0°C to +85°C	0.95	1.05	V
	Internal supply voltage relative to GND, T <sub>j</sub> = -40°C to +100°C	0.95	1.05	V
V <sub>CCAUX</sub>	Auxiliary supply voltage relative to GND, T <sub>j</sub> = 0°C to +85°C	2.375	2.625	V
	Auxiliary supply voltage relative to GND, T <sub>j</sub> = -40°C to +100°C	2.375	2.625	V
V <sub>CCO</sub> <sup>(1)(2)(3)</sup>	Supply voltage relative to GND, T <sub>j</sub> = 0°C to +85°C	1.14	2.625	V
	Supply voltage relative to GND, T <sub>j</sub> = -40°C to +100°C	1.14	2.625	V
V <sub>IN</sub>	2.5V supply voltage relative to GND, T <sub>j</sub> = 0°C to +85°C	GND - 0.20	2.625	V
	2.5V supply voltage relative to GND, T <sub>j</sub> = -40°C to +100°C	GND - 0.20	2.625	V
	2.5V and below supply voltage relative to GND, T <sub>j</sub> = 0°C to +85°C	GND - 0.20	V <sub>CCO</sub> + 0.2	V
	2.5V and below supply voltage relative to GND, T <sub>j</sub> = -40°C to +100°C	GND - 0.20	V <sub>CCO</sub> + 0.2	V
I <sub>IN</sub> <sup>(4)</sup>	Maximum current through any pin in a powered or unpowered bank when forward biasing the clamp diode.	-	10	mA
V <sub>BATT</sub> <sup>(5)</sup>	Battery voltage relative to GND, T <sub>j</sub> = 0°C to +85°C	1.0	2.5	V
	Battery voltage relative to GND, T <sub>j</sub> = -40°C to +100°C	1.0	2.5	V
V <sub>FS</sub> <sup>(6)</sup>	External voltage supply for eFUSE programming	2.375	2.625	V

**Notes:**

1. Configuration data is retained even if V<sub>CCO</sub> drops to 0V.
2. Includes V<sub>CCO</sub> of 1.2V, 1.5V, 1.8V, and 2.5V.
3. The configuration supply voltage V<sub>CC\_CONFIG</sub> is also known as V<sub>CCO\_0</sub>.
4. A total of 100 mA per bank should not be exceeded.
5. V<sub>BATT</sub> is required only when using bitstream encryption. If battery is not used, connect V<sub>BATT</sub> to either ground or V<sub>CCAUX</sub>.
6. When not programming eFUSE, connect V<sub>FS</sub> to GND.
7. All voltages are relative to ground.

Table 11: DC Characteristics Over Recommended Operating Conditions<sup>(1)(2)</sup>

Symbol	Description	Min	Typ	Max	Units
V <sub>DRINT</sub>	Data retention V <sub>CCINT</sub> voltage (below which configuration data might be lost)	0.75	-	-	V
V <sub>DRI</sub>	Data retention V <sub>CCAUX</sub> voltage (below which configuration data might be lost)	2.0	-	-	V
I <sub>REF</sub>	V <sub>REF</sub> leakage current per pin	-	-	10	μA
I <sub>L</sub>	Input or output leakage current per pin (sample-tested)	-	-	10	μA
C <sub>IN</sub> <sup>(3)</sup>	Die input capacitance at the pad	-	-	8	pF
I <sub>RPU</sub>	Pad pull-up (when selected) @ V <sub>IN</sub> = 0V, V <sub>CCO</sub> = 2.5V	20	-	80	μA
	Pad pull-up (when selected) @ V <sub>IN</sub> = 0V, V <sub>CCO</sub> = 1.8V	8	-	40	μA
	Pad pull-up (when selected) @ V <sub>IN</sub> = 0V, V <sub>CCO</sub> = 1.5V	5	-	30	μA
	Pad pull-up (when selected) @ V <sub>IN</sub> = 0V, V <sub>CCO</sub> = 1.2V	1	-	20	μA
I <sub>RPD</sub>	Pad pull-down (when selected) @ V <sub>IN</sub> = 2.5V	3	-	80	μA
I <sub>BATT</sub>	Battery supply current	-	-	150	nA
n	Temperature diode ideality factor	-	1.0002	-	n
r	Series resistance	-	5	-	Ω

**Notes:**

1. Typical values are specified at nominal voltage, 25°C.
2. Maximum value specified for worst case process at 25°C.
3. This measurement represents the die capacitance at the pad, not including the package.



## Quiescent Supply Current: Important Note

Typical values for quiescent supply current are specified at nominal voltage, 85°C junction temperatures ( $T_j$ ). Xilinx recommends analyzing static power consumption at  $T_j = 85^\circ\text{C}$  because the majority of designs operate near the high end of the commercial temperature range. Quiescent supply current is specified by speed grade for Virtex-6 CXT devices. Use the XPOWER™ Estimator (XPE) spreadsheet tool (download at <http://www.xilinx.com/power>) to calculate static power consumption for conditions other than those specified in Table 12.

Table 12: Typical Quiescent Supply Current

Symbol	Description	Device	Speed and Temperature Grade		Units
			-2 (C & I)	-1 (C & I)	
$I_{CCINTQ}$	Quiescent $V_{CCINT}$ supply current	XC6VCX75T	927	927	mA
		XC6VCX130T	1563	1563	mA
		XC6VCX195T	2059	2059	mA
		XC6VCX240T	2478	2478	mA
$I_{CCOQ}$	Quiescent $V_{CCO}$ supply current	XC6VCX75T	1	1	mA
		XC6VCX130T	1	1	mA
		XC6VCX195T	1	1	mA
		XC6VCX240T	2	2	mA
$I_{CCAUXQ}$	Quiescent $V_{CCAUX}$ supply current	XC6VCX75T	45	45	mA
		XC6VCX130T	75	75	mA
		XC6VCX195T	113	113	mA
		XC6VCX240T	135	135	mA

### Notes:

1. Typical values are specified at nominal voltage, 85°C junction temperatures ( $T_j$ ). Industrial (I) grade devices have the same typical values as commercial (C) grade devices at 85°C, but higher values at 100°C. Use the XPE tool to calculate 100°C values.
2. Typical values are for blank configured devices with no output current loads, no active input pull-up resistors, all I/O pins are 3-state and floating.
3. If DCI or differential signaling is used, more accurate quiescent current estimates can be obtained by using the XPOWER Estimator (XPE) or XPOWER Analyzer (XPA) tools.

## Power-On Power Supply Requirements

Xilinx FPGAs require a certain amount of supply current during power-on to insure proper device initialization. The actual current consumed depends on the power-on ramp rate of the power supply.

Virtex-6 CXT devices require a power-on sequence of  $V_{CCINT}$ ,  $V_{CCAUX}$ , and  $V_{CCO}$ . If the requirement can not be met, then  $V_{CCAUX}$  must always be powered prior to  $V_{CCO}$ .  $V_{CCAUX}$  and  $V_{CCO}$  can be powered by the same supply, therefore, both  $V_{CCAUX}$  and  $V_{CCO}$  are permitted to ramp simultaneously. Similarly, for the power-down sequence,  $V_{CCO}$  must be powered down prior to  $V_{CCAUX}$  or if powered by the same supply,  $V_{CCAUX}$  and  $V_{CCO}$  power-down simultaneously.

Table 13 shows the minimum current, in addition to  $I_{CCOQ}$ , that are required by Virtex-6 CXT devices for proper power-on and configuration. If the current minimums shown in Table 12 and Table 13 are met, the device powers on after all three supplies have passed through their power-on reset threshold voltages. The FPGA must be configured after  $V_{CCINT}$  is applied.

Once initialized and configured, use the XPOWER tools to estimate current drain on these supplies.

Table 13: Power-On Current for Virtex-6 CXT Devices

Device	$I_{CCINTMIN}$	$I_{CCAUXMIN}$	$I_{CCOMIN}$	Units
	Typ <sup>(1)</sup>	Typ <sup>(1)</sup>	Typ <sup>(1)</sup>	
XC6VCX75T	See $I_{CCINTQ}$ in Table 12	$I_{CCAUXQ} + 10$	$I_{CCOQ} + 30$ mA per bank	mA
XC6VCX130T	See $I_{CCINTQ}$ in Table 12	$I_{CCAUXQ} + 10$	$I_{CCOQ} + 30$ mA per bank	mA
XC6VCX195T	See $I_{CCINTQ}$ in Table 12	$I_{CCAUXQ} + 40$	$I_{CCOQ} + 30$ mA per bank	mA
XC6VCX240T	See $I_{CCINTQ}$ in Table 12	$I_{CCAUXQ} + 40$	$I_{CCOQ} + 30$ mA per bank	mA

### Notes:

- Typical values are specified at nominal voltage, 25°C.
- Use the XPOWER™ Estimator (XPE) spreadsheet tool (download at <http://www.xilinx.com/power>) to calculate maximum power-on currents.

Table 14: Power Supply Ramp Time

Symbol	Description	Ramp Time	Units
$V_{CCINT}$	Internal supply voltage relative to GND	0.20 to 50.0	ms
$V_{CCO}$	Output drivers supply voltage relative to GND	0.20 to 50.0	ms
$V_{CCAUX}$	Auxiliary supply voltage relative to GND	0.20 to 50.0	ms

## SelectIO™ DC Input and Output Levels

Values for  $V_{IL}$  and  $V_{IH}$  are recommended input voltages. Values for  $I_{OL}$  and  $I_{OH}$  are guaranteed over the recommended operating conditions at the  $V_{OL}$  and  $V_{OH}$  test points. Only selected standards are tested. These are chosen to ensure that all standards meet their specifications. The selected standards are tested at a minimum  $V_{CCO}$  with the respective  $V_{OL}$  and  $V_{OH}$  voltage levels shown. Other standards are sample tested.

Table 15: SelectIO DC Input and Output Levels

I/O Standard	$V_{IL}$		$V_{IH}$		$V_{OL}$	$V_{OH}$	$I_{OL}$	$I_{OH}$
	V, Min	V, Max	V, Min	V, Max	V, Max	V, Min	mA	mA
LVC MOS25, LVDCI25	-0.3	0.7	1.7	$V_{CCO} + 0.3$	0.4	$V_{CCO} - 0.4$	Note(3)	Note(3)
LVC MOS18, LVDCI18	-0.3	35% $V_{CCO}$	65% $V_{CCO}$	$V_{CCO} + 0.3$	0.45	$V_{CCO} - 0.45$	Note(4)	Note(4)
LVC MOS15, LVDCI15	-0.3	35% $V_{CCO}$	65% $V_{CCO}$	$V_{CCO} + 0.3$	25% $V_{CCO}$	75% $V_{CCO}$	Note(4)	Note(4)
LVC MOS12	-0.3	35% $V_{CCO}$	65% $V_{CCO}$	$V_{CCO} + 0.3$	25% $V_{CCO}$	75% $V_{CCO}$	Note(5)	Note(5)
HSTL I <sub>12</sub>	-0.3	$V_{REF} - 0.1$	$V_{REF} + 0.1$	$V_{CCO} + 0.3$	25% $V_{CCO}$	75% $V_{CCO}$	6.3	6.3
HSTL I <sup>(2)</sup>	-0.3	$V_{REF} - 0.1$	$V_{REF} + 0.1$	$V_{CCO} + 0.3$	0.4	$V_{CCO} - 0.4$	8	-8
HSTL II <sup>(2)</sup>	-0.3	$V_{REF} - 0.1$	$V_{REF} + 0.1$	$V_{CCO} + 0.3$	0.4	$V_{CCO} - 0.4$	16	-16
HSTL III <sup>(2)</sup>	-0.3	$V_{REF} - 0.1$	$V_{REF} + 0.1$	$V_{CCO} + 0.3$	0.4	$V_{CCO} - 0.4$	24	-8
DIFF HSTL I <sup>(2)</sup>	-0.3	50% $V_{CCO} - 0.1$	50% $V_{CCO} + 0.1$	$V_{CCO} + 0.3$	-	-	-	-
DIFF HSTL II <sup>(2)</sup>	-0.3	50% $V_{CCO} - 0.1$	50% $V_{CCO} + 0.1$	$V_{CCO} + 0.3$	-	-	-	-
SSTL2 I	-0.3	$V_{REF} - 0.15$	$V_{REF} + 0.15$	$V_{CCO} + 0.3$	$V_{TT} - 0.61$	$V_{TT} + 0.61$	8.1	-8.1
SSTL2 II	-0.3	$V_{REF} - 0.15$	$V_{REF} + 0.15$	$V_{CCO} + 0.3$	$V_{TT} - 0.81$	$V_{TT} + 0.81$	16.2	-16.2
DIFF SSTL2 I	-0.3	50% $V_{CCO} - 0.15$	50% $V_{CCO} + 0.15$	$V_{CCO} + 0.3$	-	-	-	-
DIFF SSTL2 II	-0.3	50% $V_{CCO} - 0.15$	50% $V_{CCO} + 0.15$	$V_{CCO} + 0.3$	-	-	-	-
SSTL18 I	-0.3	$V_{REF} - 0.125$	$V_{REF} + 0.125$	$V_{CCO} + 0.3$	$V_{TT} - 0.47$	$V_{TT} + 0.47$	6.7	-6.7
SSTL18 II	-0.3	$V_{REF} - 0.125$	$V_{REF} + 0.125$	$V_{CCO} + 0.3$	$V_{TT} - 0.60$	$V_{TT} + 0.60$	13.4	-13.4
DIFF SSTL18 I	-0.3	50% $V_{CCO} - 0.125$	50% $V_{CCO} + 0.125$	$V_{CCO} + 0.3$	-	-	-	-
DIFF SSTL18 II	-0.3	50% $V_{CCO} - 0.125$	50% $V_{CCO} + 0.125$	$V_{CCO} + 0.3$	-	-	-	-
SSTL15	-0.3	$V_{REF} - 0.1$	$V_{REF} + 0.1$	$V_{CCO} + 0.3$	$V_{TT} - 0.175$	$V_{TT} + 0.175$	14.3	14.3

**Notes:**

1. Tested according to relevant specifications.
2. Applies to both 1.5V and 1.8V HSTL.
3. Using drive strengths of 2, 4, 6, 8, 12, 16, or 24 mA.
4. Using drive strengths of 2, 4, 6, 8, 12, or 16 mA.
5. Supported drive strengths of 2, 4, 6, or 8 mA.
6. For detailed interface specific DC voltage levels, see the *Virtex-6 FPGA SelectIO Resources User Guide*.

## HT DC Specifications (HT\_25)

Table 16: HT DC Specifications

Symbol	DC Parameter	Conditions	Min	Typ	Max	Units
V <sub>CCO</sub>	Supply Voltage		2.38	2.5	2.63	V
V <sub>OD</sub>	Differential Output Voltage	R <sub>T</sub> = 100 Ω across Q and $\bar{Q}$ signals	480	600	885	mV
Δ V <sub>OD</sub>	Change in V <sub>OD</sub> Magnitude		-15	-	15	mV
V <sub>OCM</sub>	Output Common Mode Voltage	R <sub>T</sub> = 100 Ω across Q and $\bar{Q}$ signals	480	600	885	mV
Δ V <sub>OCM</sub>	Change in V <sub>OCM</sub> Magnitude		-15	-	15	mV
V <sub>ID</sub>	Input Differential Voltage		200	600	1000	mV
Δ V <sub>ID</sub>	Change in V <sub>ID</sub> Magnitude		-15	-	15	mV
V <sub>ICM</sub>	Input Common Mode Voltage		440	600	780	mV
Δ V <sub>ICM</sub>	Change in V <sub>ICM</sub> Magnitude		-15	-	15	mV

## LVDS DC Specifications (LVDS\_25)

Table 17: LVDS DC Specifications

Symbol	DC Parameter	Conditions	Min	Typ	Max	Units
V <sub>CCO</sub>	Supply Voltage		2.38	2.5	2.63	V
V <sub>OH</sub>	Output High Voltage for Q and $\bar{Q}$	R <sub>T</sub> = 100 Ω across Q and $\bar{Q}$ signals	-	-	1.675	V
V <sub>OL</sub>	Output Low Voltage for Q and $\bar{Q}$	R <sub>T</sub> = 100 Ω across Q and $\bar{Q}$ signals	0.825	-	-	V
V <sub>ODIFF</sub>	Differential Output Voltage (Q - $\bar{Q}$ ), Q = High ( $\bar{Q}$ - Q), $\bar{Q}$ = High	R <sub>T</sub> = 100 Ω across Q and $\bar{Q}$ signals	247	350	600	mV
V <sub>OCM</sub>	Output Common-Mode Voltage	R <sub>T</sub> = 100 Ω across Q and $\bar{Q}$ signals	1.075	1.250	1.425	V
V <sub>IDIFF</sub>	Differential Input Voltage (Q - $\bar{Q}$ ), Q = High ( $\bar{Q}$ - Q), $\bar{Q}$ = High		100	350	600	mV
V <sub>ICM</sub>	Input Common-Mode Voltage		0.3	1.2	2.2	V

## Extended LVDS DC Specifications (LVDSEXT\_25)

Table 18: Extended LVDS DC Specifications

Symbol	DC Parameter	Conditions	Min	Typ	Max	Units
V <sub>CCO</sub>	Supply Voltage		2.38	2.5	2.63	V
V <sub>OH</sub>	Output High Voltage for Q and $\bar{Q}$	R <sub>T</sub> = 100 Ω across Q and $\bar{Q}$ signals	-	-	1.785	V
V <sub>OL</sub>	Output Low Voltage for Q and $\bar{Q}$	R <sub>T</sub> = 100 Ω across Q and $\bar{Q}$ signals	0.715	-	-	V
V <sub>ODIFF</sub>	Differential Output Voltage (Q - $\bar{Q}$ ), Q = High ( $\bar{Q}$ - Q), $\bar{Q}$ = High	R <sub>T</sub> = 100 Ω across Q and $\bar{Q}$ signals	350	-	840	mV
V <sub>OCM</sub>	Output Common-Mode Voltage	R <sub>T</sub> = 100 Ω across Q and $\bar{Q}$ signals	1.075	1.250	1.425	V
V <sub>IDIFF</sub>	Differential Input Voltage (Q - $\bar{Q}$ ), Q = High ( $\bar{Q}$ - Q), $\bar{Q}$ = High	Common-mode input voltage = 1.25V	100	-	1000	mV
V <sub>ICM</sub>	Input Common-Mode Voltage	Differential input voltage = ±350 mV	0.3	1.2	2.2	V

## LVPECL DC Specifications (LVPECL\_25)

These values are valid when driving a 100Ω differential load only, i.e., a 100Ω resistor between the two receiver pins. The  $V_{OH}$  levels are 200 mV below standard LVPECL levels and are compatible with devices tolerant of lower common-mode ranges. Table 19 summarizes the DC output specifications of LVPECL. For more information on using LVPECL, see the *Virtex-6 FPGA SelectIO Resources User Guide*.

Table 19: LVPECL DC Specifications

Symbol	DC Parameter	Min	Typ	Max	Units
$V_{OH}$	Output High Voltage	$V_{CC} - 1.025$	1.545	$V_{CC} - 0.88$	V
$V_{OL}$	Output Low Voltage	$V_{CC} - 1.81$	0.795	$V_{CC} - 1.62$	V
$V_{ICM}$	Input Common-Mode Voltage	0.6	–	2.2	V
$V_{IDIFF}$	Differential Input Voltage <sup>(1)(2)</sup>	0.100	–	1.5	V

**Notes:**

1. Recommended input maximum voltage not to exceed  $V_{CCAUX} + 0.2V$ .
2. Recommended input minimum voltage not to go below  $-0.5V$ .

## eFUSE Read Endurance

Table 20 lists the maximum number of read cycle operations expected. For more information, see the *Virtex-6 FPGA Configuration User Guide*.

Table 20: eFUSE Read Endurance

Symbol	Description	Speed Grade				Units
		-3	-2	-1	-1L	
DNA_CYCLES	Number of DNA_PORT READ operations or JTAG ISC_DNA read command operations. Unaffected by SHIFT operations.	30,000,000				Read Cycles
AES_CYCLES	Number of JTAG FUSE_KEY or FUSE_CNTL read command operations. Unaffected by SHIFT operations.	30,000,000				Read Cycles

## GTX Transceiver Specifications

### GTX Transceiver DC Characteristics

Table 21: Absolute Maximum Ratings for GTX Transceivers<sup>(1)</sup>

Symbol	Description	Min	Max	Units
MGTA VCC	Analog supply voltage for the GTX transmitter and receiver circuits relative to GND	-0.5	1.1	V
MGTA VTT	Analog supply voltage for the GTX transmitter and receiver termination circuits relative to GND	-0.5	1.32	V
MGTA VTRCAL	Analog supply voltage for the resistor calibration circuit of the GTX transceiver column	-0.5	1.32	V
$V_{IN}$	Receiver (RXP/RXN) and Transmitter (TXP/TXN) absolute input voltage	-0.5	1.32	V
$V_{MGTR EFLK}$	Reference clock absolute input voltage	-0.5	1.32	V

**Notes:**

1. Stresses beyond those listed under Absolute Maximum Ratings might cause permanent damage to the device. These are stress ratings only, and functional operation of the device at these or any other conditions beyond those listed under Operating Conditions is not implied. Exposure to Absolute Maximum Ratings conditions for extended periods of time might affect device reliability.



Table 22: Recommended Operating Conditions for GTX Transceivers<sup>(1)(2)</sup>

Symbol	Description	Min	Typ	Max	Units
MGTA VCC	Analog supply voltage for the GTX transmitter and receiver circuits relative to GND	0.95	1.0	1.06	V
MGTA VTT	Analog supply voltage for the GTX transmitter and receiver termination circuits relative to GND	1.14	1.2	1.26	V
MGTA VTT RCAL	Analog supply voltage for the resistor calibration circuit of the GTX transceiver column	1.14	1.2	1.26	V

**Notes:**

1. Each voltage listed requires the filter circuit described in *Virtex-6 FPGA GTX Transceivers User Guide*.
2. Voltages are specified for the temperature range of  $T_j = -40^{\circ}\text{C}$  to  $+100^{\circ}\text{C}$ .

Table 23: GTX Transceiver Supply Current (per Lane) <sup>(1)(2)</sup>

Symbol	Description	Typ	Max	Units
$I_{\text{MGTA VTT}}$	MGTA VTT supply current for one GTX transceiver	55.9	Note 2	mA
$I_{\text{MGTA VCC}}$	MGTA VCC supply current for one GTX transceiver	56.1		mA
$\text{MGTR}_{\text{REF}}$	Precision reference resistor for internal calibration termination	100.0 $\pm$ 1% tolerance		$\Omega$

**Notes:**

1. Typical values are specified at nominal voltage, 25°C, with a 3.125 Gb/s line rate.
2. Values for currents other than the values specified in this table can be obtained by using the XPOWER Estimator (XPE) or XPOWER Analyzer (XPA) tools.

Table 24: GTX Transceiver Quiescent Supply Current (per Lane)<sup>(1)(2)(3)</sup>

Symbol	Description	Typ <sup>(4)</sup>	Max	Units
$I_{\text{MGTA VTTQ}}$	Quiescent MGTA VTT supply current for one GTX transceiver	0.9	Note 2	mA
$I_{\text{MGTA VCCQ}}$	Quiescent MGTA VCC supply current for one GTX transceiver	3.5		mA

**Notes:**

1. Device powered and unconfigured.
2. Currents for conditions other than values specified in this table can be obtained by using the XPOWER Estimator (XPE) or XPOWER Analyzer (XPA) tools.
3. GTX transceiver quiescent supply current for an entire device can be calculated by multiplying the values in this table by the number of available GTX transceivers.
4. Typical values are specified at nominal voltage, 25°C.

## GTX Transceiver DC Input and Output Levels

Table 25 summarizes the DC output specifications of the GTX transceivers in Virtex-6 CXT FPGAs. Consult the *Virtex-6 FPGA GTX Transceivers User Guide* for further details.

Table 25: GTX Transceiver DC Specifications

Symbol	DC Parameter	Conditions	Min	Typ	Max	Units
DV <sub>PPIN</sub>	Differential peak-to-peak input voltage	External AC coupled	125	–	2000	mV
V <sub>IN</sub>	Absolute input voltage	DC coupled MGTAVTT = 1.2V	–400	–	MGTAVTT	mV
V <sub>CMIN</sub>	Common mode input voltage	DC coupled MGTAVTT = 1.2V	–	2/3 MGTAVTT	–	mV
DV <sub>PPOUT</sub>	Differential peak-to-peak output voltage <sup>(1)</sup>	Transmitter output swing is set to maximum setting	–	–	1000	mV
V <sub>CMOUTDC</sub>	DC common mode output voltage	Equation based	MGTAVTT – DV <sub>PPOUT</sub> /4			mV
R <sub>IN</sub>	Differential input resistance		80	100	130	Ω
R <sub>OUT</sub>	Differential output resistance		80	100	120	Ω
T <sub>OSKEW</sub>	Transmitter output pair (TXP and TXN) intra-pair skew		–	2	8	ps
C <sub>EXT</sub>	Recommended external AC coupling capacitor <sup>(2)</sup>		–	100	–	nF

**Notes:**

1. The output swing and preemphasis levels are programmable using the attributes discussed in *Virtex-6 FPGA GTX Transceivers User Guide* and can result in values lower than reported in this table.
2. Other values can be used as appropriate to conform to specific protocols and standards.

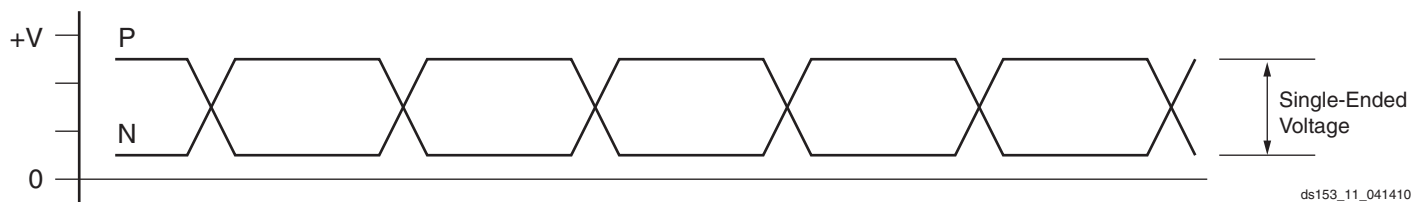

Figure 11: Single-Ended Peak-to-Peak Voltage

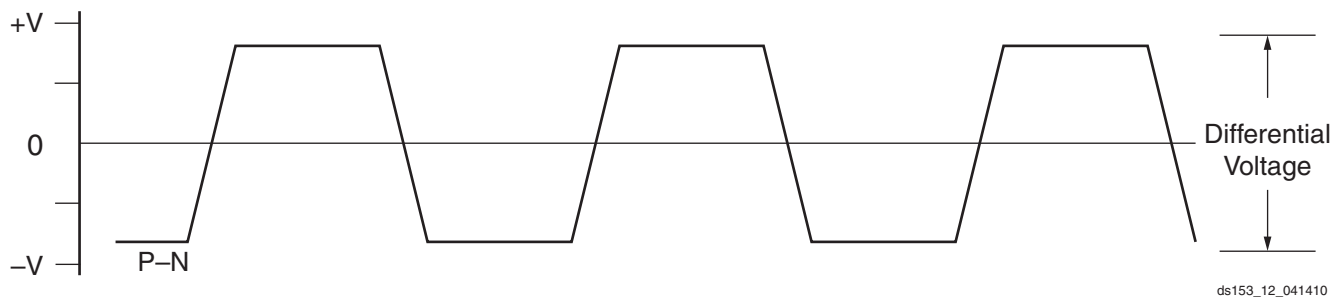

Figure 12: Differential Peak-to-Peak Voltage

Table 26 summarizes the DC specifications of the clock input of the GTX transceiver. Consult the *Virtex-6 FPGA GTX Transceivers User Guide* for further details.

Table 26: GTX Transceiver Clock DC Input Level Specification

Symbol	DC Parameter	Conditions	Min	Typ	Max	Units
V <sub>IDIFF</sub>	Differential peak-to-peak input voltage		210	800	2000	mV
R <sub>IN</sub>	Differential input resistance		90	100	130	Ω
C <sub>EXT</sub>	Required external AC coupling capacitor		–	100	–	nF

### GTX Transceiver Switching Characteristics

Consult *Virtex-6 FPGA GTX Transceivers User Guide* for further information.

Table 27: GTX Transceiver Performance

Symbol	Description	Speed Grade		Units
		-2	-1	
F <sub>GTXMAX</sub>	Maximum GTX transceiver data rate	3.75	3.75	Gb/s
F <sub>GPLLMAX</sub>	Maximum PLL frequency	2.5	2.5	GHz
F <sub>GPLLMIN</sub>	Minimum PLL frequency	1.2	1.2	GHz

Table 28: GTX Transceiver Dynamic Reconfiguration Port (DRP) Switching Characteristics

Symbol	Description	Speed Grade		Units
		-2	-1	
F <sub>GTXDRPCLK</sub>	GTXDRPCLK maximum frequency	100	100	MHz

Table 29: GTX Transceiver Reference Clock Switching Characteristics

Symbol	Description	Conditions	All Speed Grades			Units
			Min	Typ	Max	
F <sub>GCLK</sub>	Reference clock frequency range		67.5	–	375	MHz
T <sub>RCLK</sub>	Reference clock rise time	20% – 80%	–	200	–	ps
T <sub>FCLK</sub>	Reference clock fall time	80% – 20%	–	200	–	ps
T <sub>DCREF</sub>	Reference clock duty cycle	Transceiver PLL only	45	50	55	%
T <sub>LOCK</sub>	Clock recovery frequency acquisition time	Initial PLL lock	–	–	1	ms
T <sub>PHASE</sub>	Clock recovery phase acquisition time	Lock to data after PLL has locked to the reference clock	–	–	200	μs

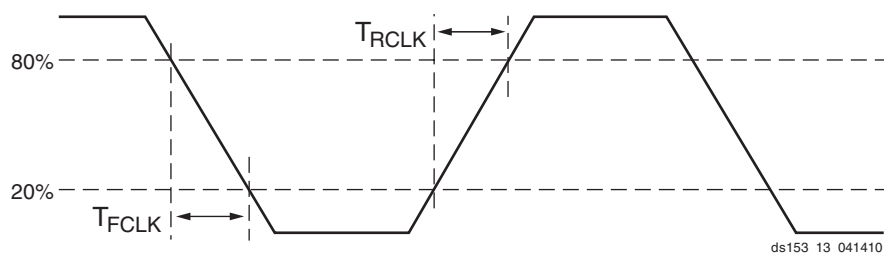

Figure 13: Reference Clock Timing Parameters

Table 30: GTX Transceiver User Clock Switching Characteristics<sup>(1)</sup>

Symbol	Description	Conditions	Speed Grade		Units
			-2	-1	
F <sub>TXOUT</sub>	TXOUTCLK maximum frequency	Internal 20-bit data path	187.5	187.5	MHz
		Internal 16-bit data path	234.38	234.38	MHz
F <sub>RXREC</sub>	RXRECCLK maximum frequency	Internal 20-bit data path	187.5	187.5	MHz
		Internal 16-bit data path	234.38	234.38	MHz
T <sub>RX</sub>	RXUSRCLK maximum frequency		234.38	234.38	MHz
T <sub>RX2</sub>	RXUSRCLK2 maximum frequency	1 byte interface	376	312.5	MHz
		2 byte interface	234.38	234.38	MHz
		4 byte interface	117.19	117.19	MHz
T <sub>TX</sub>	TXUSRCLK maximum frequency		234.38	234.38	MHz
T <sub>TX2</sub>	TXUSRCLK2 maximum frequency	1 byte interface	376	312.5	MHz
		2 byte interface	234.38	234.38	MHz
		4 byte interface	117.19	117.19	MHz

**Notes:**

1. Clocking must be implemented as described in *Virtex-6 FPGA GTX Transceivers User Guide*.

Table 31: GTX Transceiver Transmitter Switching Characteristics

Symbol	Description	Condition	Min	Typ	Max	Units
F <sub>GTXTX</sub>	Serial data rate range		0.480	–	F <sub>GTXMAX</sub>	Gb/s
T <sub>RTX</sub>	TX Rise time	20%–80%	–	120	–	ps
T <sub>FTX</sub>	TX Fall time	80%–20%	–	120	–	ps
T <sub>LLSKEW</sub>	TX lane-to-lane skew <sup>(1)</sup>		–	–	350	ps
V <sub>TXOOBVDDPP</sub>	Electrical idle amplitude		–	–	15	mV
T <sub>TXOOBTRANSITION</sub>	Electrical idle transition time		–	–	75	ns
T <sub>J3.75</sub>	Total Jitter <sup>(2)(3)</sup>	3.75 Gb/s	–	–	0.34	UI
D <sub>J3.75</sub>	Deterministic Jitter <sup>(2)(3)</sup>		–	–	0.16	UI
T <sub>J3.125</sub>	Total Jitter <sup>(2)(3)</sup>	3.125 Gb/s	–	–	0.2	UI
D <sub>J3.125</sub>	Deterministic Jitter <sup>(2)(3)</sup>		–	–	0.1	UI
T <sub>J3.125L</sub>	Total Jitter <sup>(2)(3)</sup>	3.125 Gb/s <sup>(4)</sup>	–	–	0.35	UI
D <sub>J3.125L</sub>	Deterministic Jitter <sup>(2)(3)</sup>		–	–	0.16	UI
T <sub>J2.5</sub>	Total Jitter <sup>(2)(3)</sup>	2.5 Gb/s <sup>(5)</sup>	–	–	0.20	UI
D <sub>J2.5</sub>	Deterministic Jitter <sup>(2)(3)</sup>		–	–	0.08	UI
T <sub>J1.25</sub>	Total Jitter <sup>(2)(3)</sup>	1.25 Gb/s <sup>(6)</sup>	–	–	0.15	UI
D <sub>J1.25</sub>	Deterministic Jitter <sup>(2)(3)</sup>		–	–	0.06	UI
T <sub>J600</sub>	Total Jitter <sup>(2)(3)</sup>	600 Mb/s	–	–	0.1	UI
D <sub>J600</sub>	Deterministic Jitter <sup>(2)(3)</sup>		–	–	0.03	UI

Table 31: GTX Transceiver Transmitter Switching Characteristics (Cont'd)

Symbol	Description	Condition	Min	Typ	Max	Units
T <sub>J480</sub>	Total Jitter <sup>(2)(3)</sup>	480 Mb/s	–	–	0.1	UI
D <sub>J480</sub>	Deterministic Jitter <sup>(2)(3)</sup>		–	–	0.03	UI

**Notes:**

- Using same REFCLK input with TXENPMAPHASEALIGN enabled for up to four consecutive GTX transceiver sites.
- Using PLL\_DIVSEL\_FB = 2, 20-bit internal data width. These values are NOT intended for protocol specific compliance determinations.
- All jitter values are based on a bit-error ratio of 1e<sup>-12</sup>.
- PLL frequency at 1.5625 GHz and OUTDIV = 1.
- PLL frequency at 2.5 GHz and OUTDIV = 2.
- PLL frequency at 2.5 GHz and OUTDIV = 4.

Table 32: GTX Transceiver Receiver Switching Characteristics

Symbol	Description		Min	Typ	Max	Units
F <sub>GTXRX</sub>	Serial data rate	RX oversampler not enabled	0.600	–	F <sub>GTXMAX</sub>	Gb/s
		RX oversampler enabled	0.480	–	0.600	Gb/s
T <sub>RXELECIDLE</sub>	Time for RXELECIDLE to respond to loss or restoration of data		–	75	–	ns
R <sub>XOOBVDPP</sub>	OOB detect threshold peak-to-peak		60	–	150	mV
R <sub>XSSST</sub>	Receiver spread-spectrum tracking <sup>(1)</sup>	Modulated @ 33 KHz	–5000	–	0	ppm
R <sub>XRL</sub>	Run length (CID)	Internal AC capacitor bypassed	–	–	512	UI
R <sub>XPPMTOL</sub>	Data/REFCLK PPM offset tolerance	CDR 2 <sup>nd</sup> -order loop disabled	–200	–	200	ppm
		CDR 2 <sup>nd</sup> -order loop enabled	–2000	–	2000	ppm
<b>SJ Jitter Tolerance<sup>(2)</sup></b>						
JT_SJ <sub>3.75</sub>	Sinusoidal Jitter <sup>(3)</sup>	3.75 Gb/s	0.44	–	–	UI
JT_SJ <sub>3.125</sub>	Sinusoidal Jitter <sup>(3)</sup>	3.125 Gb/s	0.45	–	–	UI
JT_SJ <sub>3.125L</sub>	Sinusoidal Jitter <sup>(3)</sup>	3.125 Gb/s <sup>(4)</sup>	0.45	–	–	UI
JT_SJ <sub>2.5</sub>	Sinusoidal Jitter <sup>(3)</sup>	2.5 Gb/s <sup>(5)</sup>	0.5	–	–	UI
JT_SJ <sub>1.25</sub>	Sinusoidal Jitter <sup>(3)</sup>	1.25 Gb/s <sup>(6)</sup>	0.5	–	–	UI
JT_SJ <sub>675</sub>	Sinusoidal Jitter <sup>(3)</sup>	675 Mb/s	0.4	–	–	UI
JT_SJ <sub>480</sub>	Sinusoidal Jitter <sup>(3)</sup>	480 Mb/s	0.4	–	–	UI
<b>SJ Jitter Tolerance with Stressed Eye<sup>(2)</sup></b>						
JT_TJSE <sub>3.125</sub>	Total Jitter with Stressed Eye <sup>(7)</sup>	3.125 Gb/s	0.70	–	–	UI
JT_SJSE <sub>3.125</sub>	Sinusoidal Jitter with Stressed Eye <sup>(7)</sup>	3.125 Gb/s	0.1	–	–	UI

**Notes:**

- Using PLL\_RXDIVSEL\_OUT = 1, 2, and 4.
- All jitter values are based on a bit-error ratio of 1e<sup>-12</sup>.
- The frequency of the injected sinusoidal jitter is 80 MHz.
- PLL frequency at 1.5625 GHz and OUTDIV = 1.
- PLL frequency at 2.5 GHz and OUTDIV = 2.
- PLL frequency at 2.5 GHz and OUTDIV = 4.
- Composite jitter with RX equalizer enabled. DFE disabled.



## Ethernet MAC Switching Characteristics

Consult *Virtex-6 FPGA Embedded Tri-mode Ethernet MAC User Guide* for further information.

Table 33: Maximum Ethernet MAC Performance

Symbol	Description	Conditions	Speed Grade		Units
			-2	-1	
F <sub>TEMACCLIENT</sub>	Client interface maximum frequency	10 Mb/s – 8-bit width	2.5 <sup>(1)</sup>	2.5 <sup>(1)</sup>	MHz
		100 Mb/s – 8-bit width	25 <sup>(2)</sup>	25 <sup>(2)</sup>	MHz
		1000 Mb/s – 8-bit width	125	125	MHz
		1000 Mb/s – 16-bit width	62.5	62.5	MHz
F <sub>TEMACPHY</sub>	Physical interface maximum frequency	10 Mb/s – 4-bit width	2.5	2.5	MHz
		100 Mb/s – 4-bit width	25	25	MHz
		1000 Mb/s – 8-bit width	125	125	MHz

### Notes:

1. When not using clock enable, the F<sub>MAX</sub> is lowered to 1.25 MHz.
2. When not using clock enable, the F<sub>MAX</sub> is lowered to 12.5 MHz.

## Integrated Interface Block for PCI Express Designs Switching Characteristics

More information and documentation on solutions for PCI Express designs can be found at:

<http://www.xilinx.com/technology/protocols/pciexpress.htm>

Table 34: Maximum Performance for PCI Express Designs

Symbol	Description	Speed Grade		Units
		-2	-1	
F <sub>PIPECLK</sub>	Pipe clock maximum frequency	125	125	MHz
F <sub>USERCLK</sub>	User clock maximum frequency	250	250	MHz
F <sub>DRPCLK</sub>	DRP clock maximum frequency	250	250	MHz

## Performance Characteristics

This section provides the performance characteristics of some common functions and designs implemented in Virtex-6 CXT devices. The numbers reported here are worst-case values; they have all been fully characterized. These values are subject to the same guidelines as the [Switching Characteristics, page 25](#).

Table 35: Interface Performances

Description	Speed Grade	
	-2	-1
<b>Networking Applications</b>		
SDR LVDS transmitter (using OSERDES; DATA_WIDTH = 4 to 8)	650 Mb/s	625 Mb/s
DDR LVDS transmitter (using OSERDES; DATA_WIDTH = 4 to 10)	1.25 Gb/s	1.0 Gb/s
SDR LVDS receiver (SFI-4.1) <sup>(1)</sup>	650 Mb/s	625 Mb/s
DDR LVDS receiver (SFI-4.2) <sup>(1)</sup>	1.0 Gb/s	0.9 Gb/s
<b>Maximum Physical Interface (PHY) Rate for Memory Interfaces<sup>(2)(3)</sup></b>		
DDR2	666 Mb/s	666 Mb/s
DDR3	800 Mb/s	666 Mb/s
QDR II + SRAM	250 MHz	250 MHz

### Notes:

1. LVDS receivers are typically bounded with certain applications where specific DPA algorithms dominate deterministic performance.
2. Based on Xilinx memory characterization platforms designed according to the guidelines in the *Virtex-6 FPGA Memory Interface Solutions User Guide*.
3. Consult the *Virtex-6 FPGA Memory Interface Solutions Data Sheet* for performance and feature information on memory interface cores (controller plus PHY).

## Switching Characteristics

All values represented in this data sheet are based on the speed specification (version 1.08). Switching characteristics are specified on a per-speed-grade basis and can be designated as Advance, Preliminary, or Production. Each designation is defined as follows:

### Advance

These specifications are based on simulations only and are typically available soon after device design specifications are frozen. Although speed grades with this designation are considered relatively stable and conservative, some under-reporting might still occur.

### Preliminary

These specifications are based on complete ES (engineering sample) silicon characterization. Devices and speed grades with this designation are intended to give a better indication of the expected performance of production silicon. The probability of under-reporting delays is greatly reduced as compared to Advance data.

## Testing of Switching Characteristics

All devices are 100% functionally tested. Internal timing parameters are derived from measuring internal test patterns. Listed below are representative values.

## Production Silicon and ISE Software Status

In some cases, a particular family member (and speed grade) is released to production before a speed specification is released with the correct label (Advance, Preliminary, Production). Any labeling discrepancies are corrected in subsequent speed specification releases. [Table 37](#) lists the production released Virtex-6 family member, speed grade, and the minimum corresponding supported speed specification version and ISE software revisions. The ISE® software and speed specifications listed are the minimum releases required for production. All subsequent releases of software and speed specifications are valid.

## Production

These specifications are released once enough production silicon of a particular device family member has been characterized to provide full correlation between specifications and devices over numerous production lots. There is no under-reporting of delays, and customers receive formal notification of any subsequent changes. Typically, the slowest speed grades transition to Production before faster speed grades.

All specifications are always representative of worst-case supply voltage and junction temperature conditions.

Since individual family members are produced at different times, the migration from one category to another depends completely on the status of the fabrication process for each device.

[Table 36](#) correlates the current status of each Virtex-6 CXT device on a per speed grade basis.

**Table 36: Virtex-6 CXT Device/Speed Grade Designations**

Device	Speed Grade Designations		
	Advance	Preliminary	Production
XC6VCX75T			-2, -1
XC6VCX130T			-2, -1
XC6VCX195T			-2, -1
XC6VCX240T			-2, -1

For more specific, more precise, and worst-case guaranteed data, use the values reported by the static timing analyzer and back-annotate to the simulation net list. Unless otherwise noted, values apply to all Virtex-6 CXT devices.

**Table 37: Virtex-6 CXT Device/Production Software and Speed Specification Release**

Device	Speed Grade Designations	
	-2	-1
XC6VCX75T	ISE 12.2 (with speed file patch) v1.06	
XC6VCX130T	ISE 12.1 v1.04	
XC6VCX195T	ISE 12.2 (with speed file patch) v1.06	
XC6VCX240T	ISE 12.1 v1.04	

### Notes:

- Blank entries indicate a device and/or speed grade in advance or preliminary status.