



Chipsmall Limited consists of a professional team with an average of over 10 year of expertise in the distribution of electronic components. Based in Hongkong, we have already established firm and mutual-benefit business relationships with customers from,Europe,America and south Asia,supplying obsolete and hard-to-find components to meet their specific needs.

With the principle of “Quality Parts,Customers Priority,Honest Operation,and Considerate Service”,our business mainly focus on the distribution of electronic components. Line cards we deal with include Microchip,ALPS,ROHM,Xilinx,Pulse,ON,Everlight and Freescale. Main products comprise IC,Modules,Potentiometer,IC Socket,Relay,Connector.Our parts cover such applications as commercial,industrial, and automotives areas.

We are looking forward to setting up business relationship with you and hope to provide you with the best service and solution. Let us make a better world for our industry!



Contact us

Tel: +86-755-8981 8866 Fax: +86-755-8427 6832

Email & Skype: info@chipsmall.com Web: www.chipsmall.com

Address: A1208, Overseas Decoration Building, #122 Zhenhua RD., Futian, Shenzhen, China



Step-Up Synchronous PFM DC/DC Converter

GENERAL DESCRIPTION

☆ GreenOperation Compatible

The XC9140 series are step-up synchronous DC/DC converters that support ceramic capacitors and have an internal 0.6Ω (TYP.) Nch driver transistor and an internal 0.65Ω (TYP.) Pch synchronous rectifier switch transistor. PFM control enables a low quiescent current, making these products ideal for portable devices that require high efficiency.

When the output voltage is 3.3V and the load current is 1mA (XC9140Axx1 type and XC9140Cxx1 type), startup from an input voltage of $V_{IN} = 0.9V$ is possible which means that these products can be used in applications that start using a single alkaline or nickel-metal hydride battery. The output voltage can be set from 1.8V to 5.0V ($\pm 2.0\%$) in steps of 0.1V.

The XC9140 features a load disconnect function to break continuity between the input and output at shutdown (XC9140A), and also a bypass mode function to maintain continuity between the input and output (XC9140C).

A version with a UVLO (Under Voltage Lock-out) function is also available. This function enables the prevention of battery leakage by stopping IC's operation when the input voltage is low. The standard product has a UVLO release voltage of 2.15V ($\pm 3.0\%$), and a custom version with a release voltage selectable from between 1.65V to 2.2V, in steps of 0.05V, is also available.

APPLICATIONS

- Mouses, Keyboards
- Bluetooths
- Household use Medical equipments
- Remote controls
- Game consoles
- Devices with 1~3 Alkaline, 1~3 Nickel Hydride, 1 Lithium and 1 Li-ion

FEATURES

Input Voltage Range	: 0.9V~5.5V
Output Voltage Setting	: 1.8V~5.0V ($\pm 2.0\%$) 0.1V increments
Output Current	: 100mA@ $V_{OUT}=3.3V$, $V_{BAT}=1.8V$ (TYP.)
Driver Transistor	: 0.6Ω Nch driver transistor 0.65Ω Pch synchronous rectifier switch transistor
Supply Current	: 6.3 μA ($V_{BAT}=V_{OUT}+0.5V$)
Control Method	: PFM Control
High speed transient response	: 50mV@ $V_{OUT}=3.3V$, $V_{BAT}=1.8V$, $I_{OUT}=1 \rightarrow 50mA$
PFM Switching Current	: 350mA
Functions	: Load Disconnection Function or Bypass Mode Function UVLO Function Ceramic Capacitor
Operating Ambient Temperature	: $-40^{\circ}C \sim +85^{\circ}C$
Packages	: SOT-25, USP-6EL
Environmentally Friendly	: EU RoHS Compliant, Pb Free

TYPICAL APPLICATION CIRCUIT

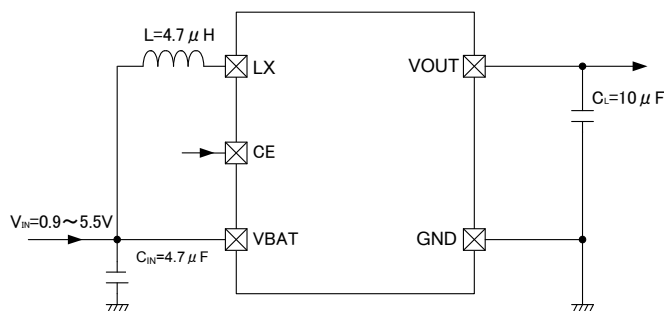

TYPICAL PERFORMANCE CHARACTERISTICS

● Efficiency vs. Output Current

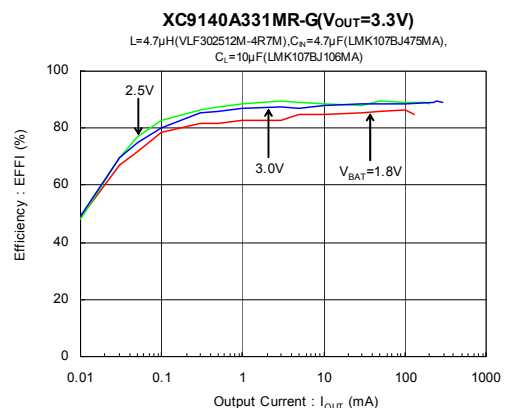

■ BLOCK DIAGRAM

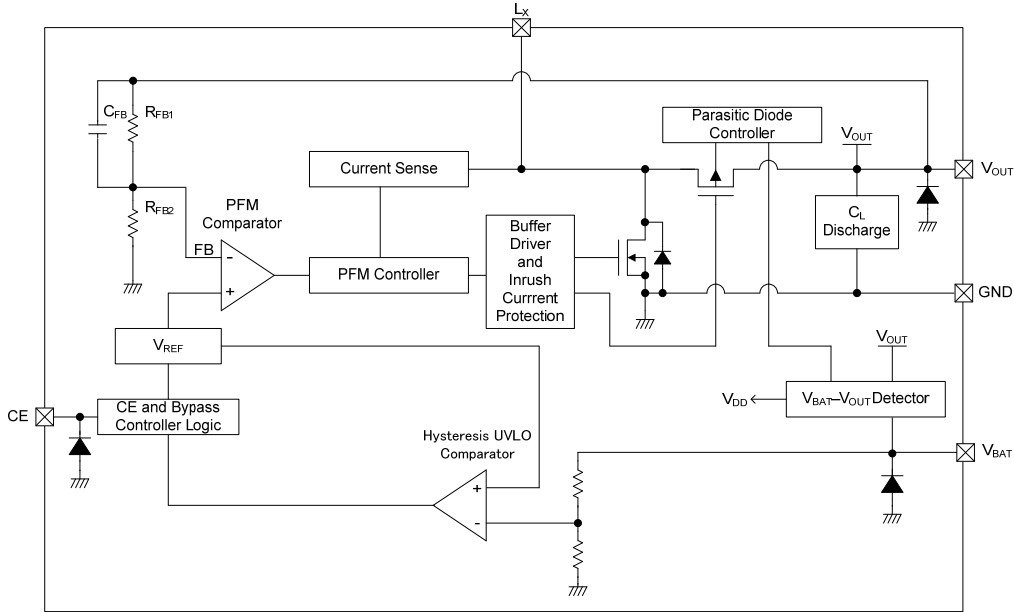

* Diodes inside the circuits are ESD protection diodes and parasitic diodes.
 The XC9140A/XC9140C series do not have the C_L discharge function.
 The XC9140Axx1/XC9140Cxx1 series do not have the UVLO function.

■ PRODUCT CLASSIFICATION

● Ordering Information

XC9140①②③④⑤⑥-⑦

DESIGNATOR	ITEM	SYMBOL	DESCRIPTION
① ⁽¹⁾	Product Type	A	Load Disconnection Without C_L Auto Discharge
		C	V_{BAT} Bypass Without C_L Auto Discharge
②③ ⁽²⁾	Output Voltage	18~50	Output Voltage e.g. $V_{OUT}=3.3V \Rightarrow$ ②=3, ③=3
④ ⁽³⁾	UVLO Function	1	No UVLO
		2	UVLO Function $V_{UVLO_R}=2.15V$
⑤⑥-⑦ ⁽⁴⁾	Packages (Order Unit)	4R-G	USP-6EL (3,000/Reel)
		MR-G	SOT-25 (3,000/Reel)

⁽¹⁾ The product with the C_L discharge function is a semi-custom product.

⁽²⁾ $V_{OUT}=3.3V$ is standard.

⁽³⁾ The standard product has a UVLO release voltage of 2.15V. For other voltages, consult our sales department.

⁽⁴⁾ The "-G" suffix denotes Halogen and Antimony free as well as being fully EU RoHS compliant.

■ PIN CONFIGURATION

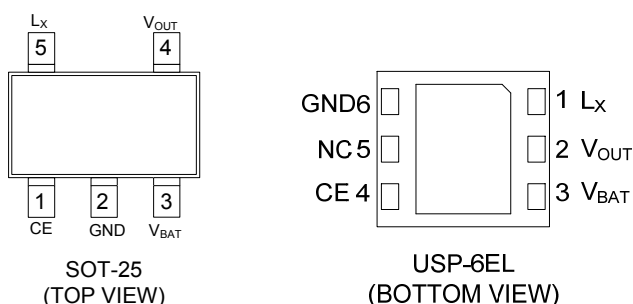

* The dissipation pad for the USP-6EL package should be solder-plated in recommended mount pattern and metal masking so as to enhance mounting strength and heat release.
The mount pattern should be connected to GND pin (No.6).

■ PIN ASSIGNMENT

PIN NUMBER		PIN NAME	FUNCTIONS
USP-6EL	SOT-25		
1	5	L _X	Switching
2	4	V _{OUT}	Output Voltage
3	3	V _{BAT}	Power Input
4	1	CE	Chip Enable
5	-	NC	No Connection
6	2	GND	Ground

■ CE PIN FUNCTION

PIN NAME	SIGNAL	STATUS
CE	H	Active (All Series)
	L	Stand-by (XC9140A Series) or Bypass Mode (XC9140C Series)

* Please do not leave the CE pin open.

■ ABSOLUTE MAXIMUM RATINGS

PARAMETER	SYMBOL	RATINGS	UNITS
BAT Pin Voltage	V _{BAT}	-0.3 ~ +7.0	V
L _X Pin Voltage	V _{LX}	-0.3 ~ V _{OUT} +0.3 or +7.0 ^(*)	V
V _{OUT} Pin Voltage	V _{OUT}	-0.3 ~ +7.0	V
CE Pin Voltage	V _{CE}	-0.3 ~ +7.0	V
L _X Pin Current	I _{LX}	700	mA
Power Dissipation	SOT-25	250	mW
	USP-6EL	120	
Operating Ambient Temperature	T _{opr}	-40 ~ +85	°C
Storage Temperature	T _{stg}	-55 ~ +125	°C

* All voltages are described based on the GND.

^(*) The maximum value should be either V_{OUT}+0.3 or +7.0 or in the lowest.

ELECTRICAL CHARACTERISTICS

●XC9140Axx1 Type, without UVLO function, without C_L discharge function

T_a=25°C

PARAMETER	SYMBOL	CONDITIONS	MIN.	TYP.	MAX.	UNITS	CIRCUIT
Input Voltage	V _{BAT}	-	-	-	5.5	V	-
Output Voltage	V _{OUT(E)} ⁽²⁾	V _{PULL} =1.5V, Voltage to start oscillation while V _{OUT} is decreasing	E1			V	①
Operation Start Voltage	V _{ST1}	I _{OUT} =1mA	-	-	0.9	V	②
Operation Hold Voltage	V _{HLD}	R _L =1kΩ	-	0.7	-	V	②
Supply Current	I _q	Oscillation stops, V _{OUT} =V _{OUT(T)} +0.5V ⁽¹⁾	E2			μA	③
Input Pin Current	I _{BAT}	V _{OUT} =V _{OUT(T)} +0.5V ⁽¹⁾	-	0.25	1.0	μA	③
Stand-by Current	I _{STB}	V _{BAT} =V _{LX} =V _{OUT(T)} ⁽¹⁾ , V _{OUT} =V _{CE} =0V	-	0.1	1.0	μA	④
L _X Leak Current	I _{LXL}	V _{BAT} =V _{LX} =V _{OUT(T)} ⁽¹⁾ , V _{OUT} =V _{CE} =0V	-	0.1	1.0	μA	⑤
PFM Switching Current	I _{PFM}	I _{OUT} =3mA	295	350	405	mA	②
Maximum ON Time	t _{ONMAX}	V _{PULL} =1.5V, V _{OUT} =V _{OUT(T)} ×0.98V ⁽¹⁾	3.1	4.6	6.0	μs	①
Efficiency ⁽³⁾	EFFI	V _{BAT} =V _{CE} =1.8V, V _{OUT(T)} ⁽¹⁾ =2.5V, I _{OUT} =30mA	-	81	-	%	②
Efficiency ⁽³⁾	EFFI	V _{BAT} =V _{CE} =1.8V, V _{OUT(T)} ⁽¹⁾ =3.3V, I _{OUT} =30mA	-	85	-	%	②
Efficiency ⁽³⁾	EFFI	V _{BAT} =V _{CE} =1.8V, V _{OUT(T)} ⁽¹⁾ =5.0V, I _{OUT} =30mA	-	86	-	%	②
LX SW "Pch" ON Resistance ⁽⁴⁾	R _{LXP}	V _{BAT} =V _{LX} =V _{CE} =V _{OUT(T)} +0.5V ⁽¹⁾ , I _{OUT} =200mA	E3			Ω	⑦
LX SW "Nch" ON Resistance ⁽⁵⁾	R _{LXN}	V _{BAT} =V _{CE} =3.3V, V _{OUT} =1.7V	-	0.6	-	Ω	⑧
CE "High" Voltage	V _{CEH}	V _{BAT} =V _{PULL} =1.5V, V _{OUT} =V _{OUT(T)} ×0.98V ⁽¹⁾ While V _{CE} =0.3→0.75V, Voltage to start oscillation	0.75	-	5.5	V	①
CE "Low" Voltage	V _{CEL}	V _{BAT} =V _{PULL} =1.5V, V _{OUT} =V _{OUT(T)} ×0.98V ⁽¹⁾ While V _{CE} =0.75→0.3V, Voltage to stop oscillation	GND	-	0.3	V	①
CE "High" Current	I _{CEH}	V _{BAT} =V _{CE} =V _{LX} =V _{OUT} =5.5V	-0.1	-	0.1	μA	①
CE "Low" Current	I _{CEL}	V _{BAT} =V _{LX} =V _{OUT} =5.5V, V _{CE} =0V	-0.1	-	0.1	μA	①

Unless otherwise stated, V_{BAT}=V_{CE}=1.5V

⁽¹⁾V_{OUT(T)}=Nominal Output Voltage

⁽²⁾V_{OUT(E)}=Effective Output Voltage

The actual output voltage value V_{OUT(E)} is the PFM comparator threshold voltage in the IC.

Therefore, the DC/DC circuit output voltage, including the peripheral components, is boosted by the ripple voltage average value.

Please refer to the characteristic example.

⁽³⁾ EFFI=[{(Output Voltage)×(Output Current)} / {(Input Voltage)×(Input Current)}]×100

⁽⁴⁾ LX SW "Pch" ON resistance=(V_{LX}-V_{OUT} pin measurement voltage) / 200mA

⁽⁵⁾ The LX SW "Nch" ON resistance measurement method is shown in the measurement circuit diagram.

■ ELECTRICAL CHARACTERISTICS (Continued)

●XC9140Cxx1 Type, without UVLO function, without C_L discharge function

T_a=25°C

PARAMETER	SYMBOL	CONDITIONS	MIN.	TYP.	MAX.	UNITS	CIRCUIT
Input Voltage	V _{BAT}		-	-	5.5	V	-
Output Voltage	V _{OUT(E)} ⁽²⁾	V _{PULL} =1.5V, Voltage to start oscillation while V _{OUT} is decreasing	E1			V	①
Operation Start Voltage	V _{ST1}	I _{OUT} =1mA	-	-	0.9	V	②
Operation Hold Voltage	V _{HLD}	R _L =1kΩ	-	0.7	-	V	②
Supply Current	I _q	Oscillation stops, V _{OUT} =V _{OUT(T)} +0.5V ⁽¹⁾	E2			μA	③
Input Pin Current	I _{BAT}	V _{OUT} =V _{OUT(T)} +0.5V ⁽¹⁾	-	0.25	1.0	μA	③
Bypass Mode Current	I _{BYP}	V _{BAT} =V _{LX} =5.5V, V _{CE} =0V	-	3.5	6.1	μA	⑥
PFM Switching Current	I _{PFM}	I _{OUT} =3mA	295	350	405	mA	②
Maximum ON Time	t _{ONMAX}	V _{PULL} =1.5V, V _{OUT} =V _{OUT(T)} ×0.98V ⁽¹⁾	3.1	4.6	6.0	μs	①
Efficiency ⁽³⁾	EFFI	V _{BAT} =V _{CE} =1.8V, V _{OUT(T)} ⁽¹⁾ =2.5V, I _{OUT} =30mA	-	81	-	%	②
Efficiency ⁽³⁾	EFFI	V _{BAT} =V _{CE} =1.8V, V _{OUT(T)} ⁽¹⁾ =3.3V, I _{OUT} =30mA	-	85	-	%	②
Efficiency ⁽³⁾	EFFI	V _{BAT} =V _{CE} =1.8V, V _{OUT(T)} ⁽¹⁾ =5.0V, I _{OUT} =30mA	-	86	-	%	②
LX SW "Pch" ON Resistance ⁽⁴⁾	R _{LXP}	V _{BAT} =V _{LX} =V _{CE} =V _{OUT(T)} +0.5V ⁽¹⁾ , I _{OUT} =200mA	E3			Ω	⑦
LX SW "Nch" ON Resistance ⁽⁵⁾	R _{LXN}	V _{BAT} =V _{CE} =3.3V, V _{OUT} =1.7V	-	0.6	-	Ω	⑧
CE "High" Voltage	V _{CEH}	V _{BAT} =V _{PULL} =1.5V, V _{OUT} =V _{OUT(T)} ×0.98V ⁽¹⁾ While V _{CE} =0.3→0.75V, Voltage to start oscillation	0.75	-	5.5	V	①
CE "Low" Voltage	V _{CEL}	V _{BAT} =V _{PULL} =1.5V, V _{OUT} =V _{OUT(T)} ×0.98V ⁽¹⁾ While V _{CE} =0.75→0.3V, Voltage to stop oscillation	GND	-	0.3	V	①
CE "High" Current	I _{CEH}	V _{BAT} =V _{CE} =V _{LX} =V _{OUT} =5.5V	-0.1	-	0.1	μA	①
CE "Low" Current	I _{CEL}	V _{BAT} =V _{LX} =V _{OUT} =5.5V, V _{CE} =0V	-0.1	-	0.1	μA	①

Unless otherwise stated, V_{BAT}=V_{CE}=1.5V

⁽¹⁾V_{OUT(T)}=Nominal Output Voltage

⁽²⁾V_{OUT(E)}=Effective Output Voltage

The actual output voltage value V_{OUT(E)} is the PFM comparator threshold voltage in the IC.

Therefore, the DC/DC circuit output voltage, including the peripheral components, is boosted by the ripple voltage average value.

Please refer to the characteristic example.

⁽³⁾EFFI=[{(Output Voltage)×(Output Current)} / {(Input Voltage)×(Input Current)}]×100

⁽⁴⁾LX SW "Pch" ON resistance=(V_{LX}-V_{OUT} pin measurement voltage) / 200mA

⁽⁵⁾The LX SW "Nch" ON resistance measurement method is shown in the measurement circuit diagram.

ELECTRICAL CHARACTERISTICS (Continued)

●XC9140Axxx types (types other than XC9140Axx1), with UVLO function, without C_L discharge function

T_a=25°C

PARAMETER	SYMBOL	CONDITIONS	MIN.	TYP.	MAX.	UNITS	CIRCUIT
Input Voltage	V _{BAT}	-	-	-	5.5	V	
Output Voltage	V _{OUT(E)} ⁽²⁾	V _{PULL} =1.5V, Voltage to start oscillation while V _{OUT} is decreasing	E1			V	①
Operation Start Voltage	V _{ST1}	I _{OUT} =1mA	-	-	V _{RELEASE(E)} ⁽⁷⁾	V	②
Operation Hold Voltage	V _{HLD}	R _L =1kΩ	V _{DETECT(E)} ⁽⁸⁾	-	-	V	②
Supply Current ₂	I _q	Oscillation stops, V _{OUT} =V _{OUT(T)} +0.5V ⁽¹⁾	E4			μA	③
Input Pin Current ₂	I _{BAT}	V _{OUT} =V _{OUT(T)} +0.5V ⁽¹⁾	E5			μA	③
Stand-by Current	I _{STB}	V _{BAT} =V _{LX} =V _{OUT(T)} ⁽¹⁾ , V _{OUT} =V _{CE} =0V	-	0.1	1.0	μA	④
L _X Leak Current	I _{LXL}	V _{BAT} =V _{LX} =V _{OUT(T)} ⁽¹⁾ , V _{OUT} =V _{CE} =0V	-	0.1	1.0	μA	⑤
PFM Switching Current	I _{PFM}	I _{OUT} =3mA	295	350	405	mA	②
Maximum ON Time	t _{ONMAX}	V _{PULL} =V _{RELEASE(T)} +0.1V ⁽⁶⁾ , V _{OUT} =V _{OUT(T)} ×0.98V ⁽¹⁾	3.1	4.6	6.0	μs	①
Efficiency ⁽³⁾	EFFI	V _{OUT(T)} ⁽¹⁾ =2.5V, I _{OUT} =30mA	-	81	-	%	②
Efficiency ⁽³⁾	EFFI	V _{OUT(T)} ⁽¹⁾ =3.3V, I _{OUT} =30mA	-	85	-	%	②
Efficiency ⁽³⁾	EFFI	V _{OUT(T)} ⁽¹⁾ =5.0V, I _{OUT} =30mA	-	86	-	%	②
LX SW "Pch" ON Resistance ⁽⁴⁾	R _{LXP}	V _{BAT} =V _{LX} =V _{CE} =V _{OUT(T)} +0.5V ⁽¹⁾ , I _{OUT} =200mA	E3			Ω	⑦
LX SW "Nch" ON Resistance ⁽⁵⁾	R _{LXN}	V _{BAT} =V _{CE} =3.3V, V _{OUT} =1.7V	-	0.6	-	Ω	⑧
CE "High" Voltage	V _{CEH}	V _{BAT} =V _{PULL} =V _{RELEASE(T)} +0.1V ⁽⁶⁾ , V _{OUT} =V _{OUT(T)} ×0.98V ⁽¹⁾ While V _{CE} =0.3→0.75V, Voltage to start oscillation	0.75	-	5.5	V	①
CE "Low" Voltage	V _{CEL}	V _{BAT} =V _{PULL} =V _{RELEASE(T)} +0.1V ⁽⁶⁾ , V _{OUT} =V _{OUT(T)} ×0.98V ⁽¹⁾ While V _{CE} =0.75→0.3V, Voltage to stop oscillation	GND	-	0.3	V	①
CE "High" Current	I _{CEH}	V _{BAT} =V _{CE} =V _{LX} =V _{OUT} =5.5V	-0.1	-	0.1	μA	①
CE "Low" Current	I _{CEL}	V _{BAT} =V _{LX} =V _{OUT} =5.5V, V _{CE} =0V	-0.1	-	0.1	μA	①
UVLO Current	I _{DQ}	V _{BAT} =V _{CE} =V _{DETECT(E)} -0.1V ⁽⁸⁾ , I _{OUT} =0mA	E6			μA	②
UVLO Release Voltage	V _{RELEASE(E)} ⁽⁷⁾	V _{PULL} =V _{OUT} =V _{OUT(T)} ×0.98V ⁽¹⁾ , V _{BAT} =V _{CE} Voltage to start oscillation while V _{BAT} is increasing	E7			V	①
UVLO Hysteresis Voltage	V _{HYS(E)} ⁽⁹⁾	V _{PULL} =V _{OUT} =V _{OUT(T)} ×0.98V ⁽¹⁾ , V _{BAT} =V _{CE} V _{RELEASE(E)} - Voltage to stop oscillation while V _{BAT} is decreasing ⁽⁷⁾	0.1	0.15	0.2	V	①

Unless otherwise stated, V_{BAT}=V_{CE}=V_{RELEASE(T)}+0.1V⁽⁶⁾

⁽¹⁾V_{OUT(T)}= Nominal Output Voltage

⁽²⁾V_{OUT(E)}= Effective Output Voltage

The actual output voltage value V_{OUT(E)} is the PFM comparator threshold voltage in the IC. Therefore, the DC/DC circuit output voltage, including the peripheral components, is boosted by the ripple voltage average value. Please refer to the characteristic example.

⁽³⁾ EFFI=[{(Output Voltage)×(Output Current)} / {(Input Voltage)×(Input Current)}]×100

⁽⁴⁾ LX SW "Pch" ON resistance=(V_{LX}-V_{OUT} pin measurement voltage) / 200mA

⁽⁵⁾ The LX SW "Nch" ON resistance measurement method is shown in the measurement circuit diagram.

⁽⁶⁾ V_{RELEASE(T)}= Nominal UVLO release voltage

⁽⁷⁾ V_{RELEASE(E)}= Actual UVLO release voltage

⁽⁸⁾ V_{DETECT(E)}=V_{RELEASE(E)}-V_{HYS(E)}= Actual UVLO detect voltage

⁽⁹⁾ V_{HYS(E)}= Actual UVLO hysteresis voltage

■ ELECTRICAL CHARACTERISTICS (Continued)

●XC9140Cxxx type (types other than XC9140Cxx1), with UVLO function, without C_L discharge function

Ta=25°C

PARAMETER	SYMBOL	CONDITIONS	MIN.	TYP.	MAX.	UNITS	CIRCUIT
Input Voltage	V _{BAT}		-	-	5.5	V	
Output Voltage	V _{OUT(E)} ⁽²⁾	V _{PULL} =1.5V, Voltage to start oscillation while V _{OUT} is decreasing	E1			V	①
Operation Start Voltage	V _{ST1}	I _{OUT} =1mA	-	-	V _{RELEASE(E)} ⁽⁷⁾	V	②
Operation Hold Voltage	V _{HLD}	R _L =1kΩ	V _{DETECT(E)} ⁽⁸⁾	-	-	V	②
Supply Current2	I _q	Oscillation stops, V _{OUT} =V _{OUT(T)} +0.5V ⁽¹⁾	E4			μA	③
Input Pin Current2	I _{BAT}	V _{OUT} =V _{OUT(T)} +0.5V ⁽¹⁾	E5			μA	③
Bypass Mode Current	I _{BYP}	V _{BAT} =V _{LX} =V _{RELEASE(T)} +0.1V ⁽⁶⁾ , V _{CE} =0V	-	5.5	8.1	μA	⑥
PFM Switching Current	I _{PFM}	I _{OUT} =3mA	295	350	405	mA	②
Maximum ON Time	t _{ONMAX}	V _{PULL} =V _{RELEASE(T)} +0.1V ⁽⁶⁾ , V _{OUT} =V _{OUT(T)} ×0.98V ⁽¹⁾	3.1	4.6	6.0	μs	①
Efficiency ⁽³⁾	EFFI	V _{OUT(T)} ⁽¹⁾ =2.5V, I _{OUT} =30mA	-	81	-	%	②
Efficiency ⁽³⁾	EFFI	V _{OUT(T)} ⁽¹⁾ =3.3V, I _{OUT} =30mA	-	85	-	%	②
Efficiency ⁽³⁾	EFFI	V _{OUT(T)} ⁽¹⁾ =5.0V, I _{OUT} =30mA	-	86	-	%	②
LX SW "Pch" ON Resistance ⁽⁴⁾	R _{LXP}	V _{BAT} =V _{LX} =V _{CE} =V _{OUT(T)} +0.5V ⁽¹⁾ , I _{OUT} =200mA	E3			Ω	⑦
LX SW "Nch" ON Resistance ⁽⁵⁾	R _{LXN}	V _{BAT} =V _{CE} =3.3V, V _{OUT} =1.7V	-	0.6	-	Ω	⑧
CE "High" Voltage	V _{CEH}	V _{BAT} =V _{PULL} =V _{RELEASE(T)} +0.1V ⁽⁶⁾ , V _{OUT} =V _{OUT(T)} ×0.98V ⁽¹⁾ While V _{CE} =0.3→0.75V, Voltage to start oscillation	0.75	-	5.5	V	①
CE "Low" Voltage	V _{CEL}	V _{BAT} =V _{PULL} =V _{RELEASE(T)} +0.1V ⁽⁶⁾ , V _{OUT} =V _{OUT(T)} ×0.98V ⁽¹⁾ While V _{CE} =0.75→0.3V, Voltage to stop oscillation	GND	-	0.3	V	①
CE "High" Current	I _{CEH}	V _{BAT} =V _{CE} =V _{LX} =V _{OUT} =5.5V	-0.1	-	0.1	μA	①
CE "Low" Current	I _{CEL}	V _{BAT} =V _{LX} =V _{OUT} =5.5V, V _{CE} =0V	-0.1	-	0.1	μA	①
UVLO Current	I _{DQ}	V _{BAT} =V _{CE} =V _{DETECT(E)} -0.1V ⁽⁸⁾ , I _{OUT} =0mA	E6			μA	②
UVLO Bypass Current	I _{DBYP}	V _{BAT} =V _{LX} =V _{DETECT(E)} -0.1V ⁽⁸⁾ , V _{CE} =0V	E8			μA	⑥
UVLO Release Voltage	V _{RELEASE(E)} ⁽⁷⁾	V _{PULL} =V _{OUT} =V _{OUT(T)} ×0.98V ⁽¹⁾ , V _{BAT} =V _{CE} Voltage to start oscillation while V _{BAT} is increasing	E7			V	①
UVLO Hysteresis Voltage	V _{HYS(E)} ⁽⁹⁾	V _{PULL} =V _{OUT} =V _{OUT(T)} ×0.98V ⁽¹⁾ , V _{BAT} =V _{CE} V _{RELEASE(E)} - Voltage to stop oscillation while V _{BAT} is decreasing ⁽⁷⁾	0.1	0.15	0.2	V	①

Unless otherwise stated, V_{BAT}=V_{CE}=V_{RELEASE(T)}+0.1V⁽⁶⁾

⁽¹⁾V_{OUT(T)}=Nominal Output Voltage

⁽²⁾V_{OUT(E)}=Effective Output Voltage

The actual output voltage value V_{OUT(E)} is the PFM comparator threshold voltage in the IC. Therefore, the DC/DC circuit output voltage, including the peripheral components, is boosted by the ripple voltage average value. Please refer to the characteristic example.

⁽³⁾ EFFI=[{(Output Voltage)×(Output Current)} / {(Input Voltage)×(Input Current)}]×100

⁽⁴⁾ LX SW "Pch" ON resistance=(V_{LX}-V_{OUT} pin measurement voltage) / 200mA

⁽⁵⁾ The LX SW "Nch" ON resistance measurement method is shown in the measurement circuit diagram.

⁽⁶⁾ V_{RELEASE(T)}= Nominal UVLO release voltage

⁽⁷⁾ V_{RELEASE(E)}= Actual UVLO release voltage

⁽⁸⁾ V_{DETECT(E)}= V_{RELEASE(E)}-V_{HYS(E)}= Actual UVLO detect voltage

⁽⁹⁾ V_{HYS(E)}= Actual UVLO hysteresis voltage

ELECTRICAL CHARACTERISTICS (Continued)

XC9140 Voltage Chart 1

SYMBOL	E1		E2		E3		E4	
PARAMETER	Output Voltage		Supply Current		LX SW "Pch" ON RESISTANCE		Supply Current ²	
UNITS: V	UNITS: V		UNITS: μA		UNITS: Ω		UNITS: μA	
OUTPUT VOLTAGE	MIN.	MAX.	TYP.	MAX.	TYP.	MAX.	TYP.	MAX.
1.8	1.764	1.836	6.1	9.4	0.84	1.08	6.8	9.7
1.9	1.862	1.938						
2.0	1.960	2.040						
2.1	2.058	2.142						
2.2	2.156	2.244						
2.3	2.254	2.346	6.2	9.7	0.75	0.97	6.9	9.8
2.4	2.352	2.448						
2.5	2.450	2.550						
2.6	2.548	2.652						
2.7	2.646	2.754						
2.8	2.744	2.856	6.3	10.0	0.65	0.85	7.0	10.0
2.9	2.842	2.958						
3.0	2.940	3.060						
3.1	3.038	3.162						
3.2	3.136	3.264						
3.3	3.234	3.366	6.4	10.2	0.61	0.78	7.1	10.1
3.4	3.332	3.468						
3.5	3.430	3.570						
3.6	3.528	3.672						
3.7	3.626	3.774						
3.8	3.724	3.876	6.5	10.4	0.57	0.74	7.2	10.2
3.9	3.822	3.978						
4.0	3.920	4.080						
4.1	4.018	4.182						
4.2	4.116	4.284						
4.3	4.214	4.386	6.7	10.7	0.53	0.72	7.3	10.3
4.4	4.312	4.488						
4.5	4.410	4.590						
4.6	4.508	4.692						
4.7	4.606	4.794						
4.8	4.704	4.896	4.9	4.998	4.900	5.100		
4.9	4.802	4.998						
5.0	4.900	5.100						

■ ELECTRICAL CHARACTERISTICS (Continued)

XC9140 Voltage Chart 2

SYMBOL	E5		E6		E7		E8	
PARAMETER	Input Pin Current ²		UVLO Current		UVLO RELEASE VOLTAGE		UVLO Bypass Current	
UNITS: V	UNITS: μ A		UNITS: μ A		UNITS: V		UNITS: μ A	
UVLO Release Voltage	TYP.	MAX.	TYP.	MAX.	MIN.	MAX.	TYP.	MAX.
1.65	0.71	1.50	3.25	6.00	1.601	1.699	2.15	4.10
1.70					1.649	1.751		
1.75	0.73	1.60	3.27	6.10	1.698	1.802	2.20	4.20
1.80					1.746	1.854		
1.85	0.75	1.60	3.29	6.20	1.795	1.905	2.30	4.20
1.90					1.843	1.957		
1.95	0.77	1.60	3.31	6.20	1.892	2.008	2.35	4.30
2.00					1.940	2.060		
2.05	0.79	1.70	3.33	6.30	1.989	2.111	2.40	4.30
2.10					2.037	2.163		
2.15	0.82	1.70	3.35	6.30	2.086	2.214	2.45	4.40
2.20					2.134	2.266		

TEST CIRCUITS

< Test Circuit No.① >

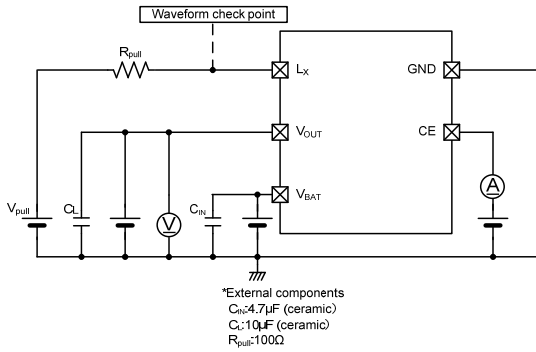

< Test Circuit No.⑤ >

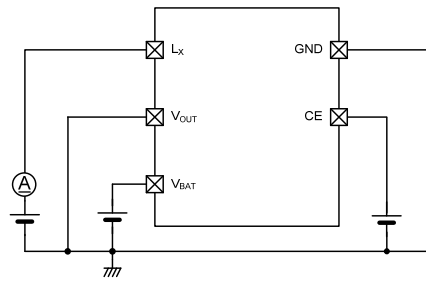

< Test Circuit No.② >

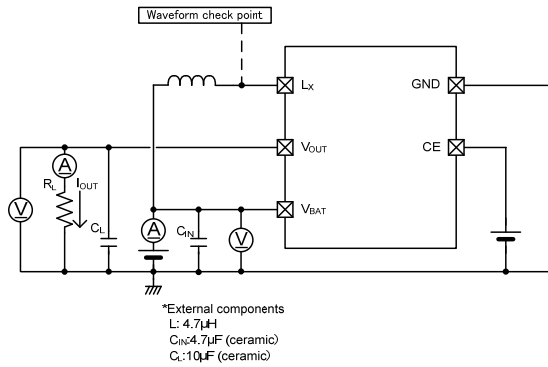

< Test Circuit No.⑥ >

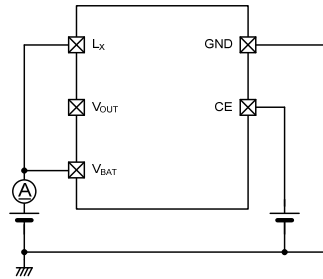

< Test Circuit No.③ >

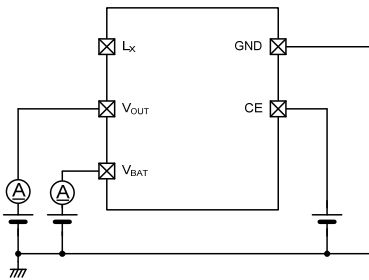

< Test Circuit No.⑦ >

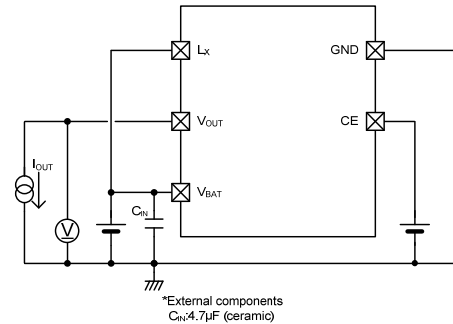

< Test Circuit No.④ >

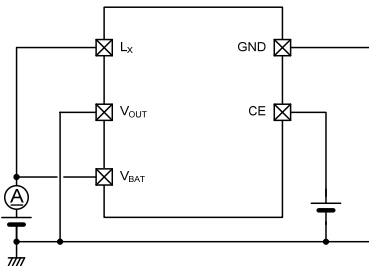

< Test Circuit No.⑧ >

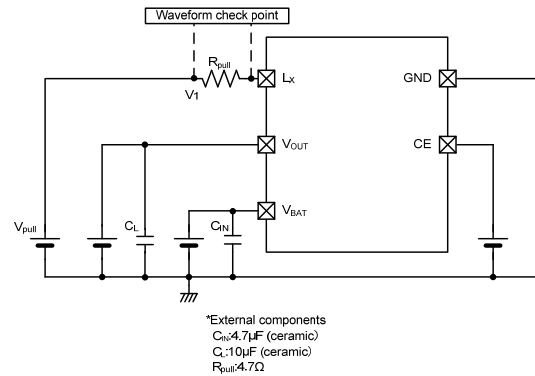

<L_x SW "Nch" ON Resistance Measurement Method>

Use Test Circuit No.8 to adjust V_{pull} so that the L_x pin voltage becomes 100mV when the Nch drive Tr is ON and then the voltage at both ends of R_{pull} is measured to find the L_x SW "Nch" ON resistance.

$$R_{LxN} = 0.1 / \{(V1 - 0.1) / 4.7\}$$

Note that V1 is the R_{pull} previous voltage when the Nch driver Tr is ON. Use an oscilloscope or other instrument to measure the L_x pin voltage and V1.

■ TYPICAL APPLICATION CIRCUIT

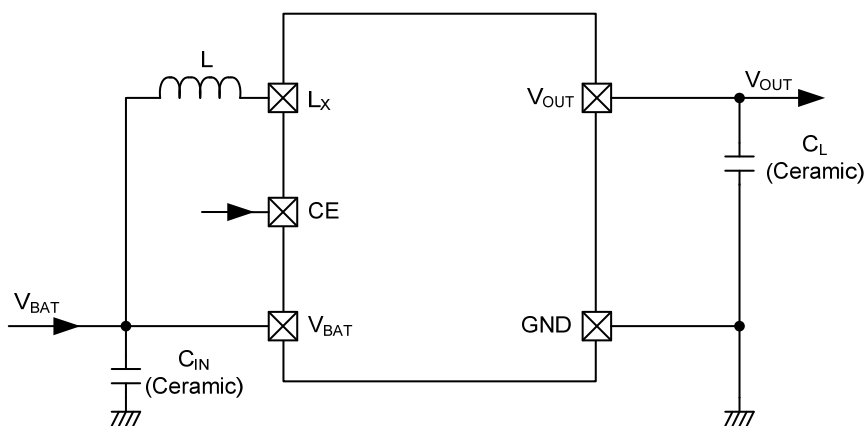

【Reference External Components】

	MANUFACTURE	PRODUCT NUMBER	VALUE
L	TDK	VLF302512M-4R7	4.7 μ H
C _{IN}	TAIYO YUDEN	LMK107BJ475MA	4.7 μ F/10V
C _L	TAIYO YUDEN	LMK107BJ106MA	10 μ F/10V

- * When selecting components, take into consideration capacitance reduction, voltage, etc.
- * The characteristics are dependent on the variation in the coil inductance value, so check these carefully in the actual product.
- * A coil inductance value of 4.7 to 10.0 μ H can be used, but using 4.7 μ H is recommended.
- * The ripple voltage will increase if tantalum or electrolytic capacitors are used for the load capacitor C_L. The operation could also become unstable, so carefully check this in the actual product.

OPERATIONAL EXPLANATION

The XC9140 Series consists of a standard voltage source, a PFM comparator, a Nch driver Tr, a Pch synchronous rectifier switch Tr, a current sense circuit, a PFM control circuit and a CE control circuit, etc. (refer to the block diagram below.)

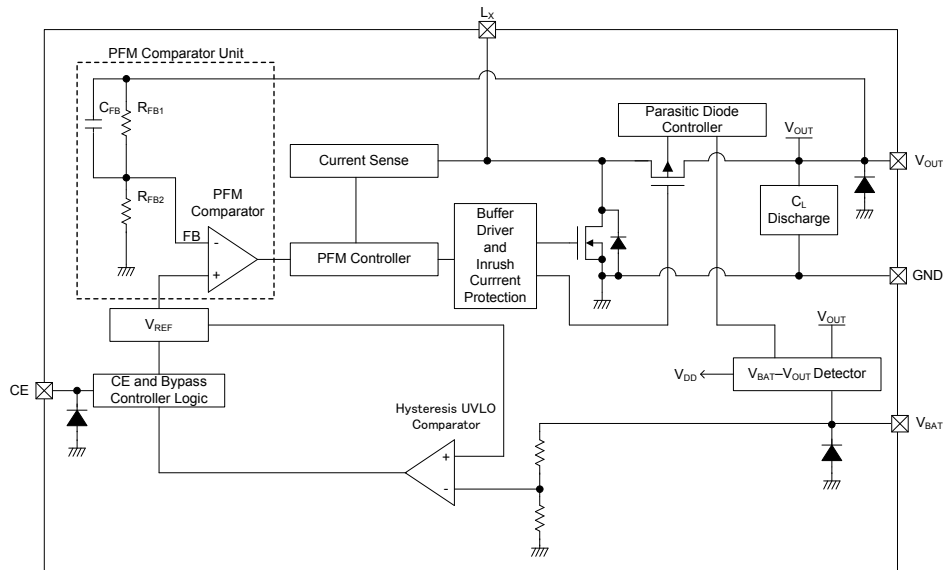

Current limit PFM control is used for the control method to make it difficult for the output voltage ripple to increase even when the switching current is superimposed, so the product can be used within a wide voltage and current range. Further, because PFM control is used, it has excellent transient response to support low capacity ceramic capacitors to realize a compact, high-performance boost DC/DC converter. The synchronous driver and rectifier switch Tr efficiently sends the coil energy to the capacitor connected to the V_{OUT} pin to achieve highly efficient operation from low to high loads.

The electrical characteristics actual output voltage V_{OUT(E)} is the PFM comparator threshold voltage shown in the block diagram. Therefore, the booster circuit output voltage average value, including the peripheral components, depends on the ripple voltage, so this must be carefully evaluated before being used in the actual product.

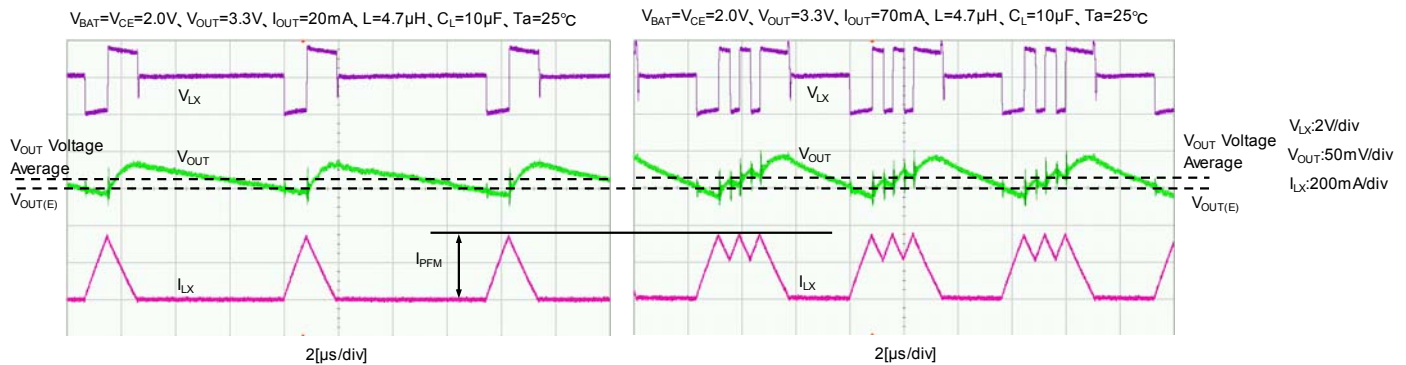

< Reference Voltage Source (V_{REF}) >

The reference voltage source (V_{REF} voltage) provides the reference voltage to ensure stable output voltage of the DC/DC converter.

< PFM Control >

① The voltage from the output voltage divided by the division resistors R_{FB1} and R_{FB2} in the IC is used as feedback voltage (FB voltage), and the PFM comparator is compared with the FB voltage and V_{REF}. If the FB voltage is lower than V_{REF}, the signal is sent to the buffer driver via the PFM control circuit and the Nch driver Tr is turned ON. If the FB voltage is higher than V_{REF}, the PFM comparator sends a signal that does not turn ON the Nch driver Tr.

② The current sense circuit monitors the current flowing in the Nch driver Tr connected to the Lx pin when the Nch driver Tr is ON. When the prescribed PFM switching current (I_{PFM}) is reached, the signal is sent to the buffer driver via the PFM control circuit to turn OFF the Nch driver Tr and turn ON the Pch synchronous rectifier switch Tr.

③ The Pch synchronous rectifier switch Tr ON time (off time) is dynamically optimized internally. After the off time has passed, when the PFM comparator confirms the V_{OUT} voltage has exceeded the set voltage, a signal that does not allow the Nch driver Tr to be turned on is sent from the PFM comparator to the PFM control circuit, but if the V_{OUT} voltage remains lower than the set voltage, then Nch driver Tr ON is started.

The intervals of the above ①②③ linked operations are continuously adjusted in response to the load current to ensure the output voltage is kept stable from low to high loads and that it is done with good efficiency.

■ OPERATIONAL EXPLANATION (Continued)

<PFM Switching Current>

The PFM switching current unit monitors the current flowing in the Nch driver Tr and functions to limit the current flowing in the Nch driver Tr, but if the load current becomes much larger than the PFM switching energy, the V_{OUT} voltage becomes lower and prevents the coil current in the Nch driver Tr OFF period from lowering, which affects the internal circuit delay time and results in an excessive current that is larger than the PFM switching current flowing in the Nch driver Tr and Pch synchronous rectifier switch Tr.

<Load Disconnection Function, Bypass Mode>

When a "L" voltage is input to the CE pin, the XC9140A type enters into standby mode and the XC9140C type enters into bypass mode to stop the circuit required for the boost operation.

In the standby mode the load cut-off function operates and both the Nch driver Tr and Pch synchronous rectifier switch Tr are turned OFF, which cuts off the current to the L_X pin and V_{OUT} pin and the parasitic diode control circuit connects the parasitic diode cathode of the Pch synchronous rectifier switch Tr to the L_X pin ①. In the bypass mode the Nch driver Tr is OFF, the Pch synchronous rectifier switch Tr is ON when $V_{LX} > V_{OUT}$, and the parasitic diode control circuit connects the parasitic diode cathode of the Pch synchronous rectifier switch Tr to the V_{OUT} pin ②. Also, when $V_{LX} < V_{OUT}$, the Pch synchronous rectifier switch Tr is turned OFF and the parasitic diode cathode is connected to the V_{OUT} pin ②.

Note: Except for the moment when the V_{BAT} voltage is input.

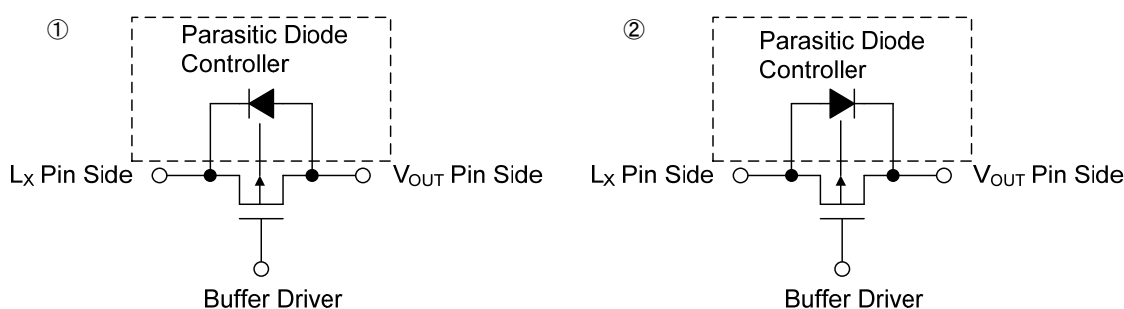

< V_{BAT} - V_{OUT} Voltage Detection Circuit >

The V_{BAT} - V_{OUT} voltage detection circuit compares the V_{BAT} pin voltage with the V_{OUT} pin voltage, and whichever is the highest is operated to become the IC power supply (V_{DD}).

In addition, if, during normal operation, the input voltage becomes higher than the output voltage, the Nch driver Tr is turned OFF and the Pch synchronous rectifier switch Tr is kept ON so that the input voltage pass through to the output voltage (through mode). When the input voltage becomes lower than the output voltage, the circuit automatically returns to the normal boost operation. This detection circuit does not operate when in the standby mode.

<Inrush Current Protection Function>

When the V_{BAT} or V_{CE} power supply is input, C_L is charged via the stable current that results from the inrush current protection function (refer to graphs below). Therefore, this function minimizes potential over current from the V_{BAT} pin to the V_{OUT} pin. Also, this current value depends on the V_{BAT} voltage. After C_L is charged by the aforementioned stable current and V_{OUT} reaches around the V_{BAT} voltage level, the inrush current protection function will be released after several hundred μs ~ several ms and the IC will then move to step-up mode, by pass mode or through mode.

Inrush Current Protection Characteristics

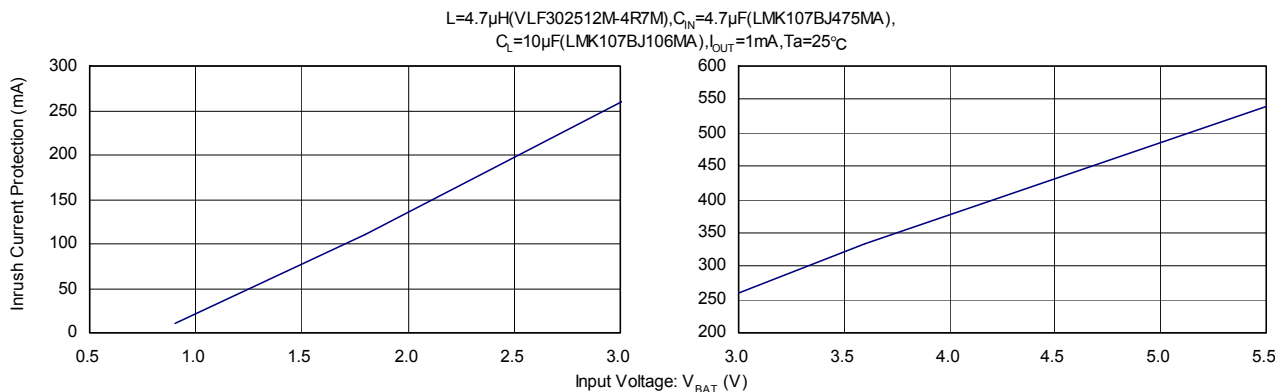

OPERATIONAL EXPLANATION (Continued)

<UVLO Function >

The UVLO function is selectable on the XC9140 series as an option. When the V_{BAT} pin voltage falls below the UVLO detect voltage, the IC stops switching or BYPASS operation and cuts off the current to the L_X pin and V_{OUT} pin (UVLO mode). In addition, when the V_{BAT} pin voltage recovers to above the UVLO release voltage, the IC begins operating again.

< C_L Discharge Function>

With the XC9140 Series an optional C_L discharge function (under development) can be selected. This function uses the Nch Tr connected between V_{OUT} and GND to discharge, at high speed, the load capacity C_L charge when the "L" voltage is input to the CE pin (when in the IC standby mode). This is done to prevent malfunction of the application caused by a residual charge in C_L when the IC is stopped. The discharge time is determined by the C_L discharge resistance R_{DCHG} , including the Nch Tr, and C_L . The constant $\tau = C_L \times R_{DCHG}$ is determined at this time, and the following formula is used to find the output voltage discharge time. However, the C_L discharge resistance R_{DCHG} varies depending on the V_{BAT} or V_{OUT} voltage, so the discharge time cannot be determined easily. Therefore, carefully check this in the actual product.

$$V = V_{OUT} \times e^{-t/\tau} \text{ or } t = \tau \ln(V_{OUT} / V)$$

V: Output voltage after discharge

V_{OUT} : Output voltage

t: Discharge time

τ : $C_L \times R_{DCHG}$

C_L : Capacity value of the load capacitor (C_L)

R_{DCHG} : Low resistance value of the C_L discharge resistance.

However, this changes depending on the voltage.

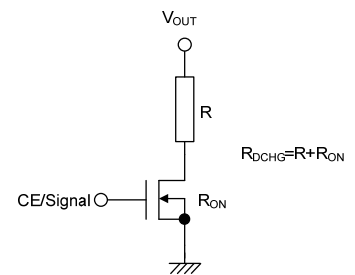

The XC9140A/ XC9140C series do not have a C_L discharge function as standard.

NOTE ON USE

1. Be careful not to exceed the absolute maximum ratings for externally connected components and this IC.
2. The DC/DC converter characteristics greatly depend not only on the characteristics of this IC but also on those of externally connected components, so refer to the specifications of each component and be careful when selecting the components. Be especially careful of the characteristics of the capacitor used for the load capacity C_L and use a capacitor with B characteristics (JIS Standard) or an X7R/X5R (EIA Standard) ceramic capacitor.
3. Use a ground wire of sufficient strength. Ground potential fluctuation caused by the ground current during switching could cause the IC operation to become unstable, so reinforce the area around the GND pin of the IC in particular.
4. Mount the externally connected components in the vicinity of the IC. Also use short, thick wires to reduce the wire impedance.
5. An excessive current that is larger than the PFM switching current flowing in the Nch driver T_r and Pch synchronous rectifier switch T_r , which could destroy the IC.
6. When in the bypass mode, the internal Pch synchronous rectifier switch T_r turns ON to allow current to flow to the Lx pin and V_{OUT} pin. When an excessive current comes from the V_{OUT} pin when this bypass operates, it could destroy the Pch synchronous rectifier switch T_r .
7. The CE pin does not have an internal pull-up or pull-down, etc. Apply the prescribed voltage to the CE pin.
8. The coil inductance value applicable range is $4.7\ \mu\text{H}$ to $10\ \mu\text{H}$, but $4.7\ \mu\text{H}$ is recommended because at this value the coil size and DC/DC performance are optimized. If you want to use another inductance value other than $4.7\ \mu\text{H}$ but which is in the above applicable range, be sure to carefully evaluate it first before use.
9. At high temperatures, the product performance could vary causing the efficiency to decline. Evaluate this carefully before use if the product will be used at high temperatures.
10. Please note that the leak current of the Pch synchronous rectifier switch T_r during high-temperature standby operation could cause the output voltage to increase.
11. The output voltage ripple effect from the load current causes the output voltage average value to fluctuate, so carefully evaluate this in the actual product before use.
12. When the booster circuit is activated by a low input voltage, during the time until the output voltage reaches about 1.7V, the PFM switching current function might not operate causing the coil current to be superimposed. (See the figure below.)

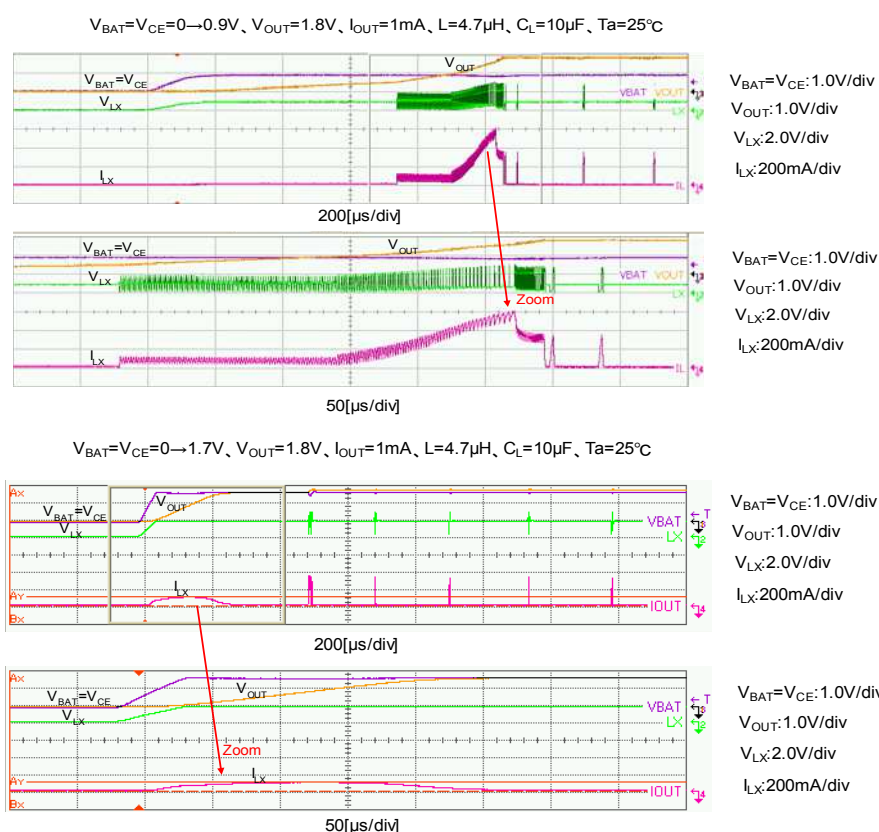

NOTE ON USE (Continued)

13. If the C_L capacity or load current becomes excessively large, the output voltage start-up time, when the power is turned on, will increase, so the coil current might be superimposed during the time it takes for the output voltage to become sufficiently higher than the V_{BAT} voltage.
14. If the input voltage is higher than the output voltage, then the circuit automatically enters the through mode. When the input voltage becomes close to the output voltage, there could be repeated switching between the boost mode and through mode causing the ripple voltage to fluctuate. (Refer to the graphic below)

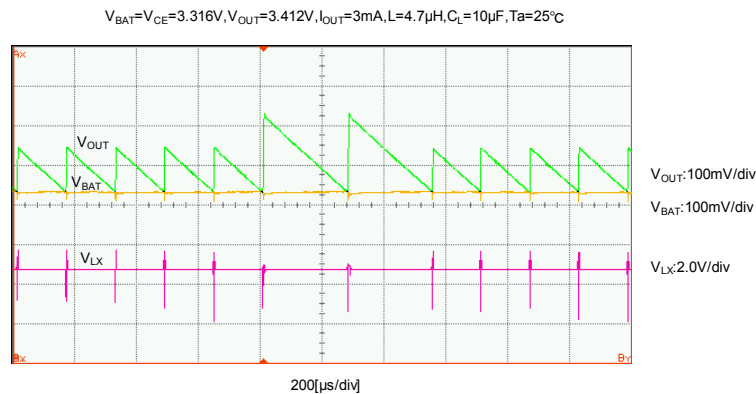

15. If a different power supply is connected from an external source to the XC9140A/XC9140C, the IC could be destroyed.
16. For temporary, transitional voltage drop or voltage rising phenomenon, the IC is liable to malfunction should the ratings be exceeded.
17. Torex places an importance on improving our products and their reliability.
We request that users incorporate fail-safe designs and post-aging protection treatment when using Torex products in their systems.
18. With the XC9140A, when the V_{BAT} or V_{CE} power supply is input, if the V_{OUT} pin voltage does not exceed $V_{BAT} - 0.35V$, which can happen due to the load current being more than the inrush protection current, step-up mode or through mode operations won't function correctly.
19. With the XC9140C, when the V_{BAT} power supply is input, if the V_{OUT} pin voltage does not exceed $V_{BAT} - 0.35V$, which can happen due to the load current being more than the inrush protection current, by pass mode operations won't function correctly.
20. In the case of products with the UVLO function that do not have C_L discharge, the output voltage may occasionally rise due to leakage current from the Pch synchronous switch T_r when high-temperature UVLO mode operates.

■ NOTE ON USE (Continued)

● Instructions of pattern layouts

1. In order to stabilize V_{BAT} voltage level, we recommend that a by-pass capacitor (C_{IN}) be connected as close as possible to the V_{BAT} and ground pins.
2. Please mount each external component as close to the IC as possible.
3. Wire external components as close to the IC as possible and use thick, short connecting traces to reduce the circuit impedance.
4. Make sure that the ground traces are as thick as possible, as variations in ground potential caused by high ground currents at the time of switching may result in instability of the IC.
5. Internal driver transistors bring on heat because of the transistor current and ON resistance of the driver transistors.

● Recommended Pattern Layout (SOT-25)

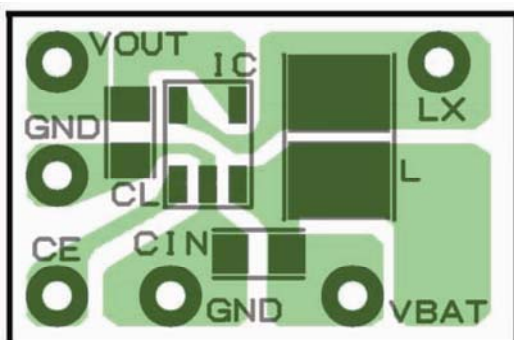

FRONT

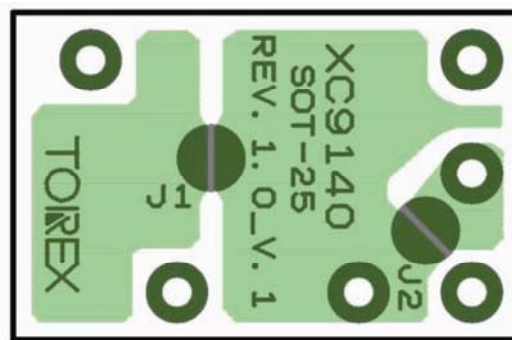

BACK

● Recommended Pattern Layout (USP-6EL)

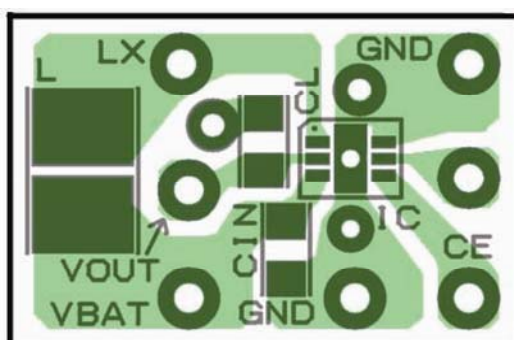

FRONT

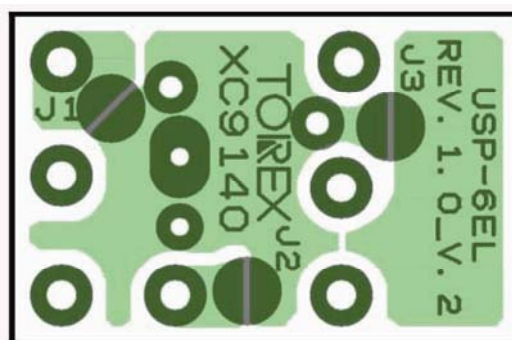

BACK

TYPICAL PERFORMANCE CHARACTERISTICS

(1) Efficiency vs. Output Current

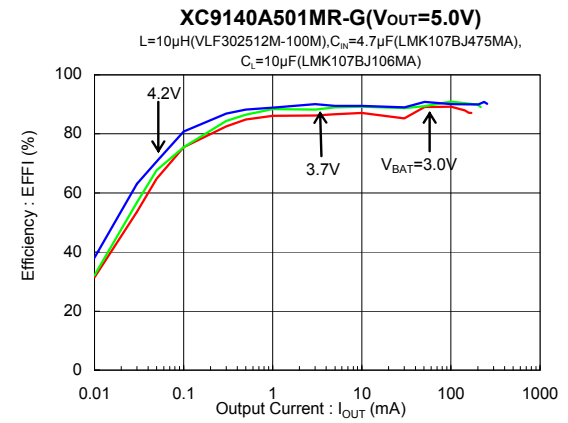
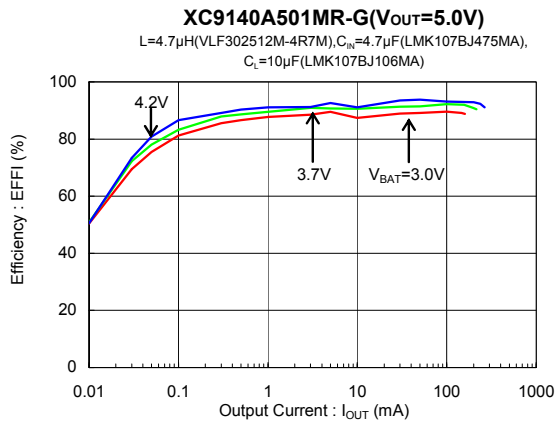
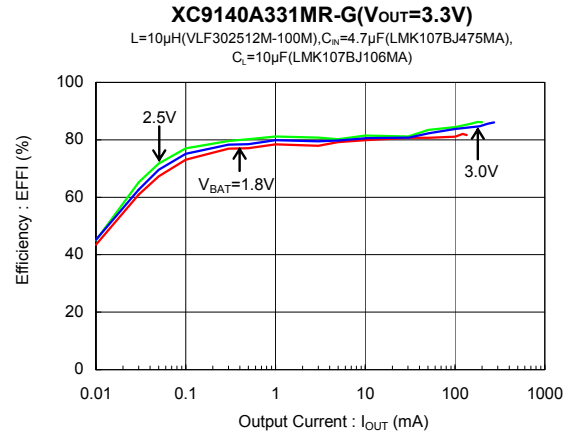
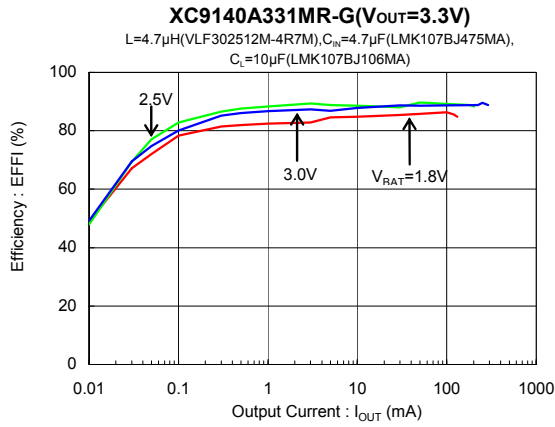

(2) Output Voltage vs. Output Current

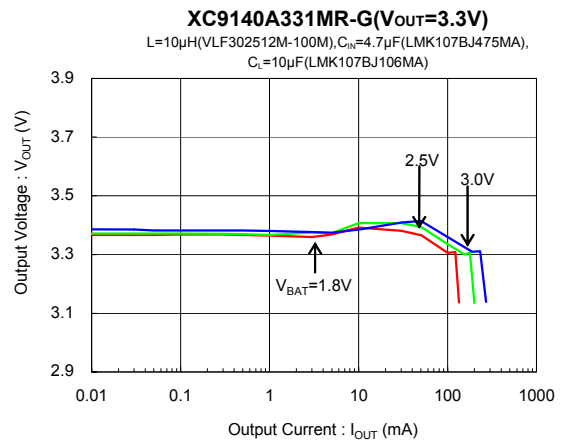
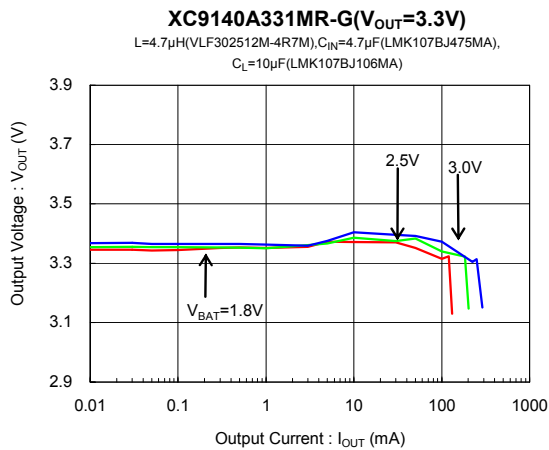

■ TYPICAL PERFORMANCE CHARACTERISTICS (Continued)

(2) Output Voltage vs. Output Current (Continued)

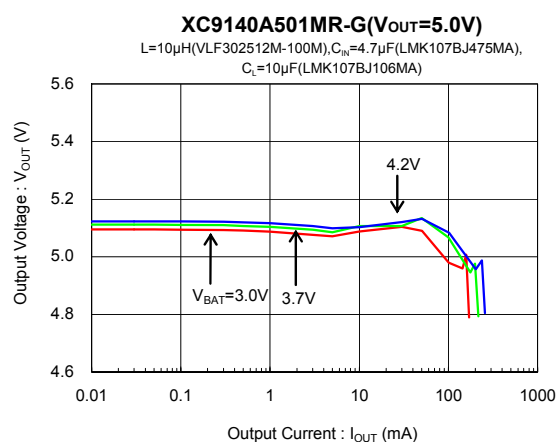
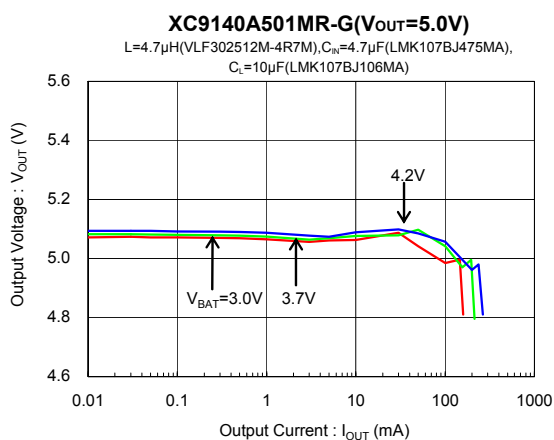

(3) Ripple Voltage vs. Output Current

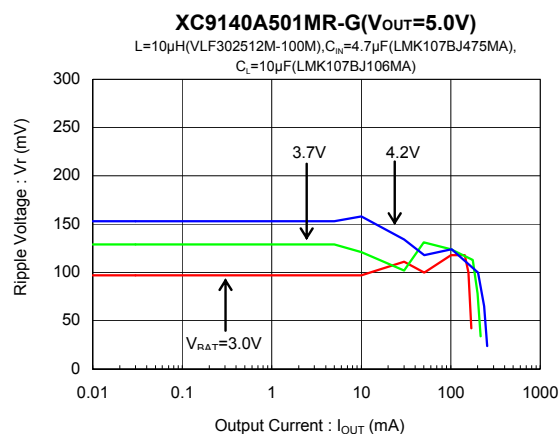
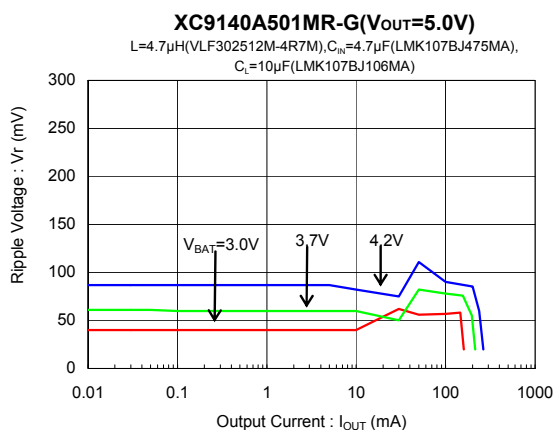
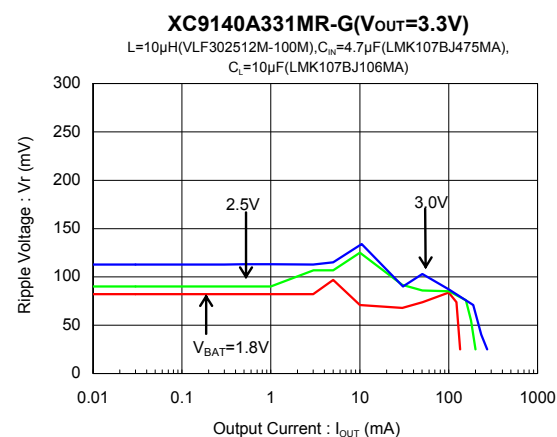
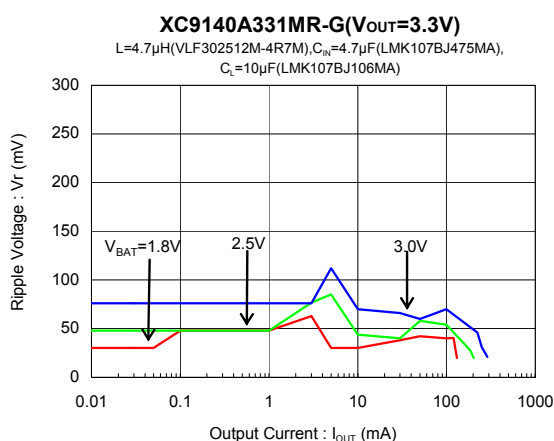

TYPICAL PERFORMANCE CHARACTERISTICS (Continued)

(4) Output Voltage vs. Ambient Temperature

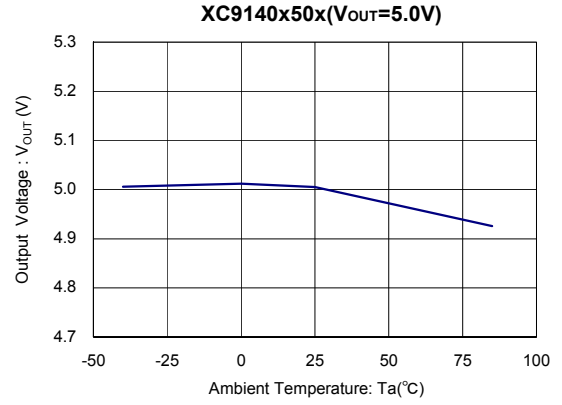
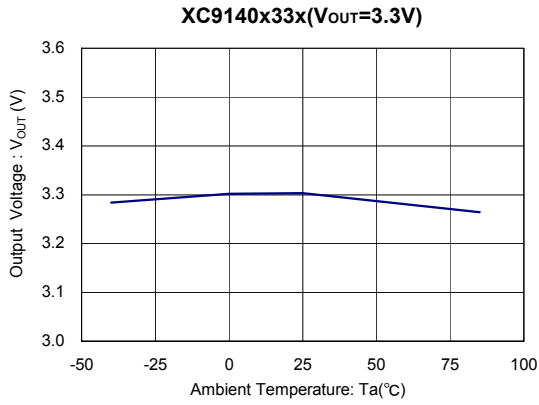

(5) Supply Current vs. Ambient Temperature

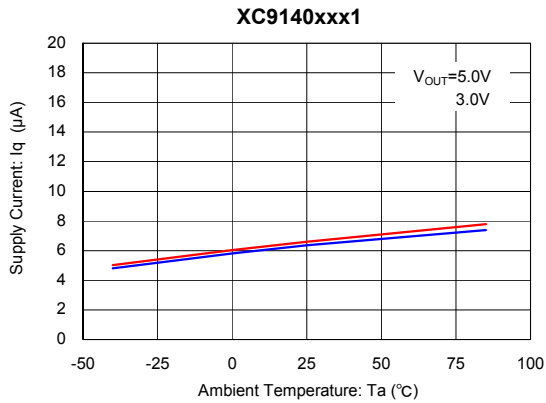

(6) Input Pin Current vs. Ambient Temperature

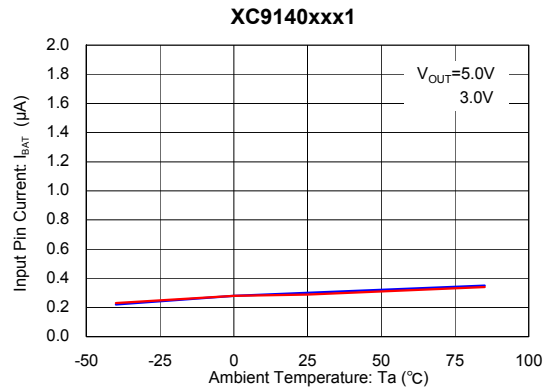

(7) Stand-by Current vs. Ambient Temperature

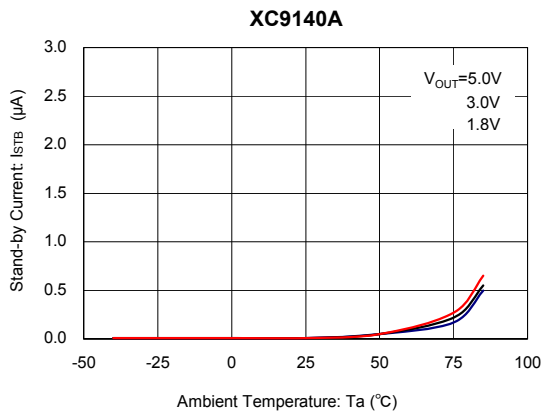

■ TYPICAL PERFORMANCE CHARACTERISTICS (Continued)

(8) PFM Switching Current vs. Ambient Temperature

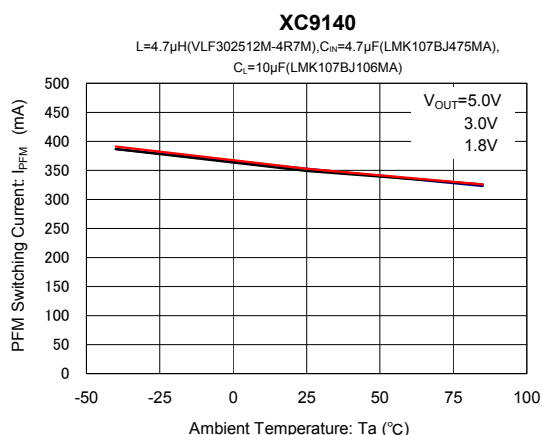

(9) PFM Switching Current vs. Input Voltage

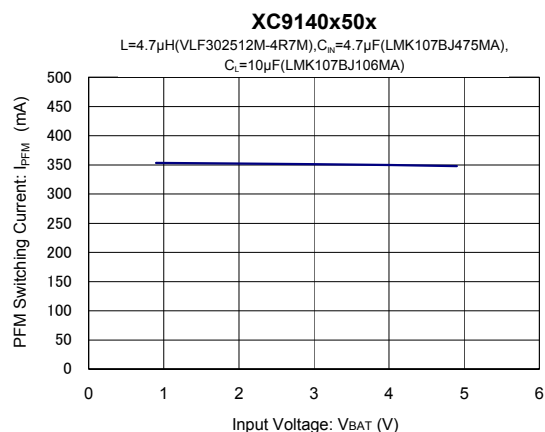

(10) MAX. ON Time vs. Ambient Temperature

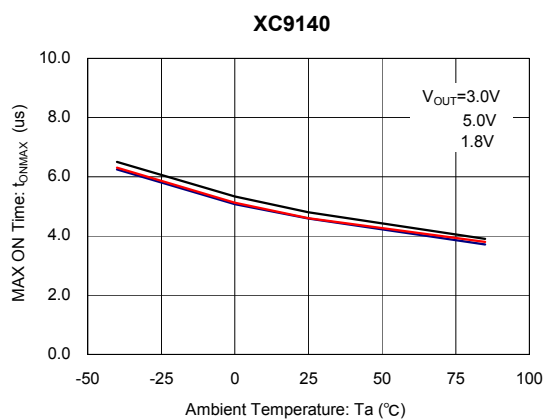

(11) Lx SW "Nch" ON Resistance vs. Output Voltage

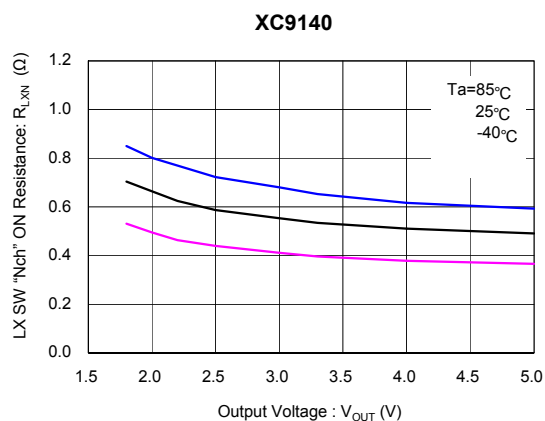

(12) Lx SW "Pch" ON Resistance vs. Output Voltage

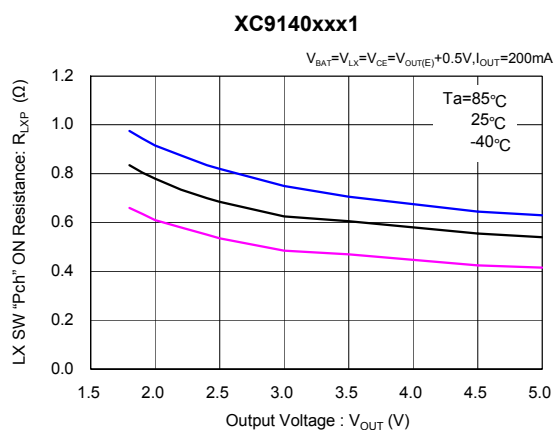

(13) Lx Leak Current vs. Ambient Temperature

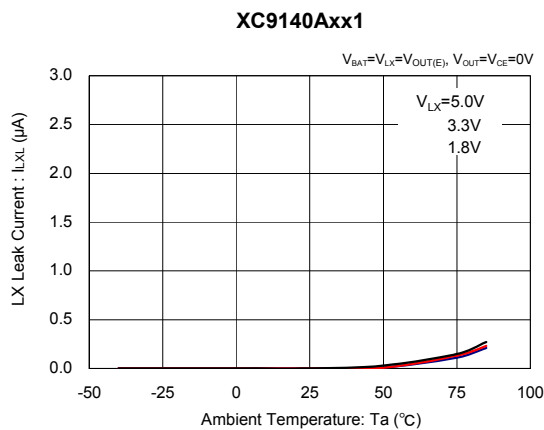

TYPICAL PERFORMANCE CHARACTERISTICS (Continued)

(14) CE "High" Voltage vs. Output Voltage

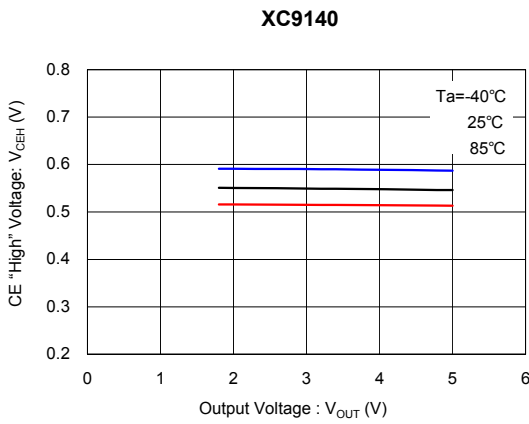

(15) CE "Low" Voltage vs. Output Voltage

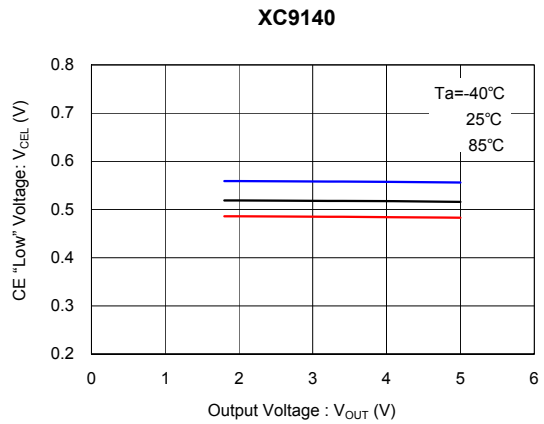

(16) Operation Start Voltage vs. Ambient Temperature

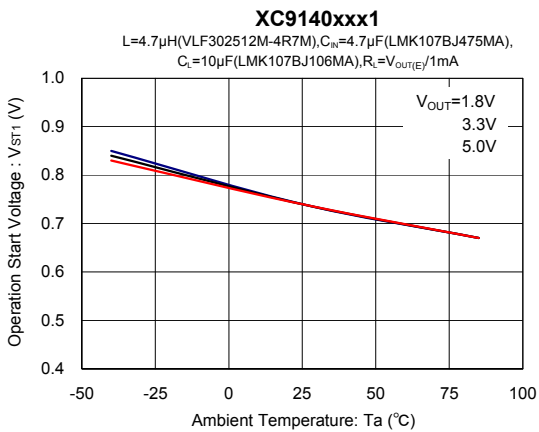

(17) Operation Hold Voltage vs. Ambient Temperature

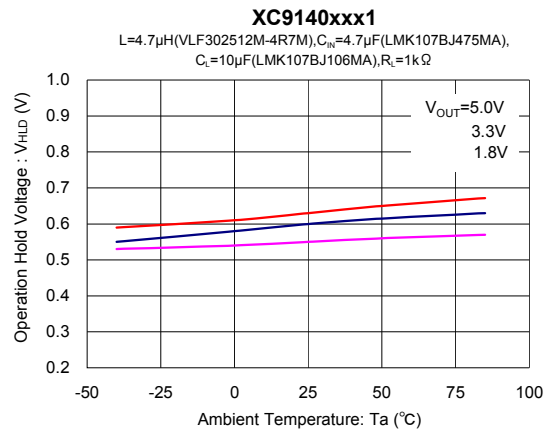

(18) UVLO Release Voltage vs. Ambient Temperature

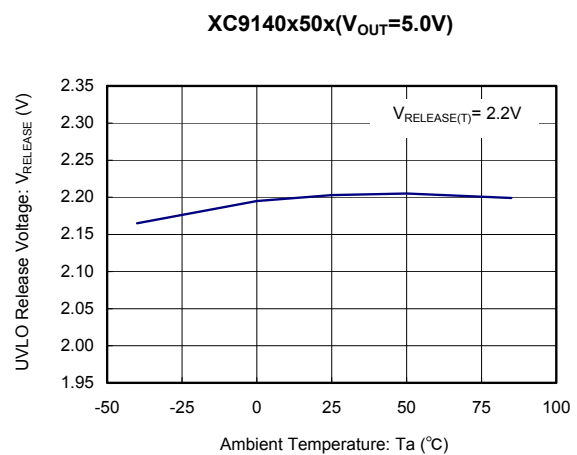
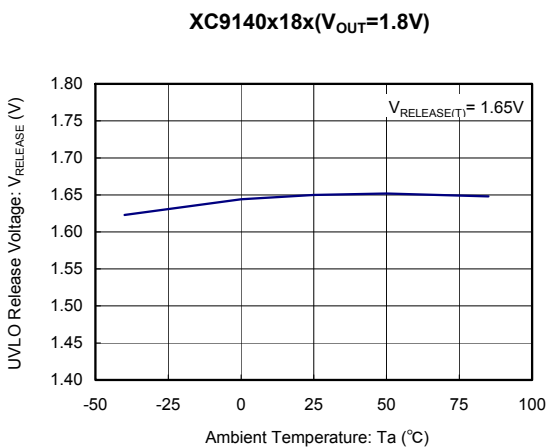

■ TYPICAL PERFORMANCE CHARACTERISTICS (Continued)

(19) UVLO Detect Voltage vs. Ambient Temperature

XC9140x18x(V_{OUT}=1.8V)

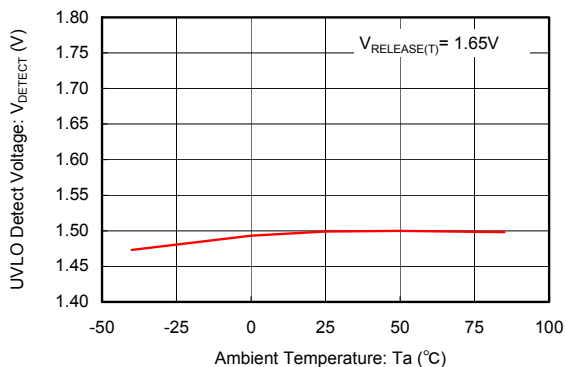

XC9140x50x(V_{OUT}=5.0V)

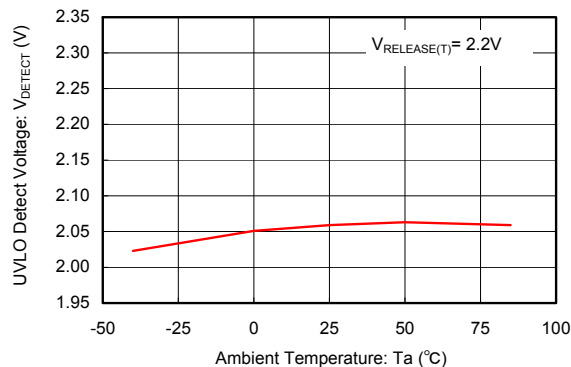

(20) UVLO Hysteresis Voltage vs. Ambient Temperature

XC9140x18x(V_{OUT}=1.8V)

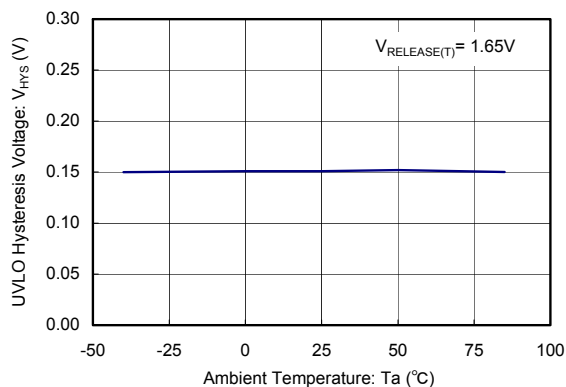

XC9140x50x(V_{OUT}=5.0V)

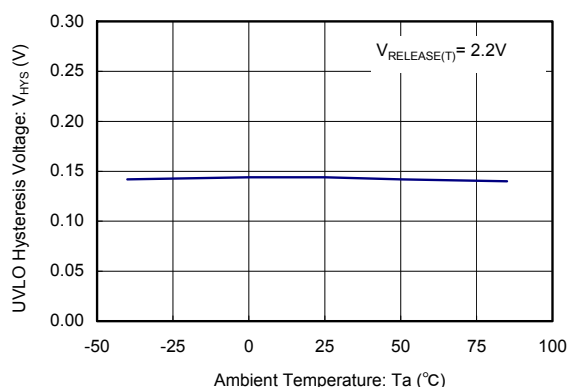

(21) No Load Input Current vs. Input Voltage

XC9140x18x(V_{OUT}=1.8V)

L=4.7μH(VLF302512M-4R7M),CIN=4.7μF(LMK107BJ475MA),
CL=10μF(LMK107BJ106MA),V_{BAT}=V_{CE,IOUT}=0mA

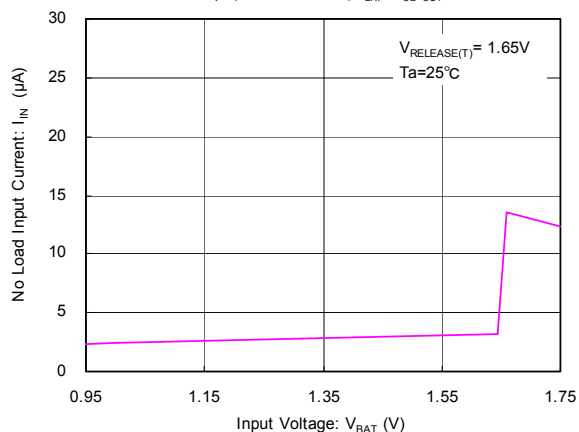

XC9140x50x(V_{OUT}=5.0V)

L=4.7μH(VLF302512M-4R7M),CIN=4.7μF(LMK107BJ475MA),
CL=10μF(LMK107BJ106MA),V_{BAT}=V_{CE,IOUT}=0mA

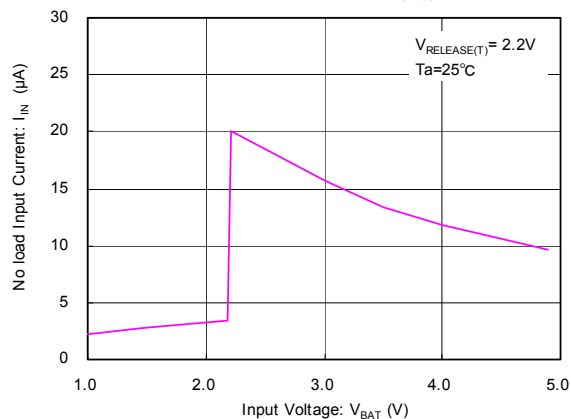

TYPICAL PERFORMANCE CHARACTERISTICS (Continued)

(22) UVLO Bypass Current vs. Input Voltage

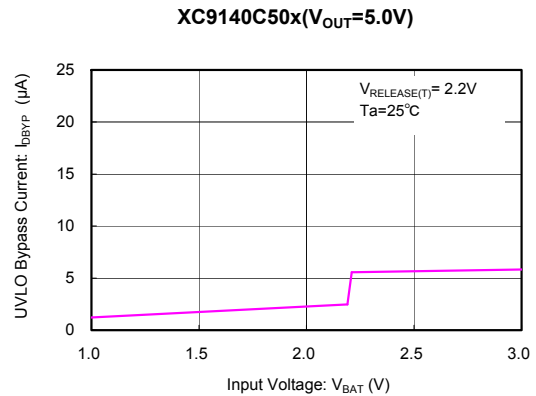
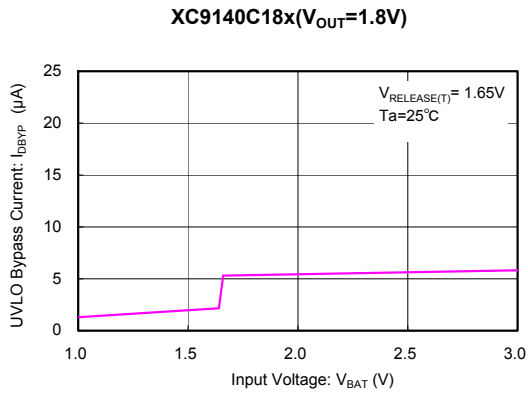

(23) Rising Output Voltage

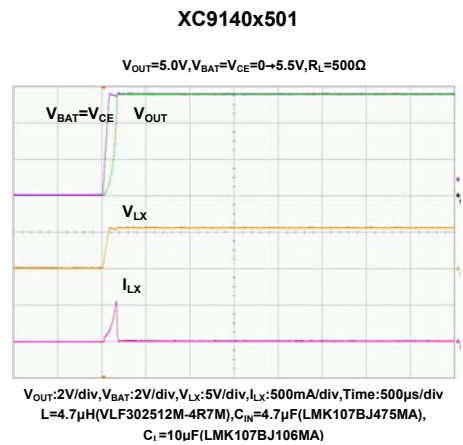
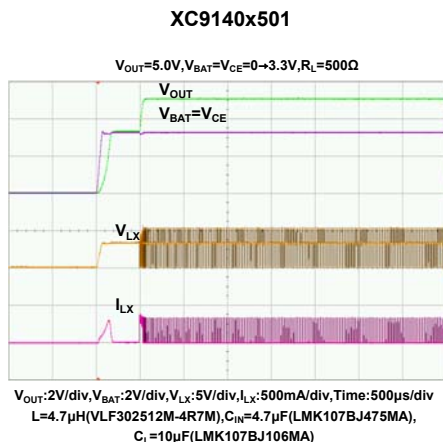
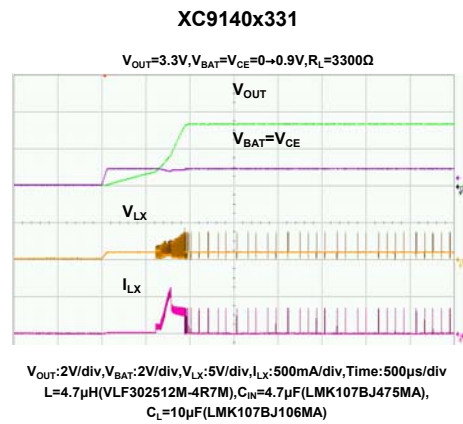
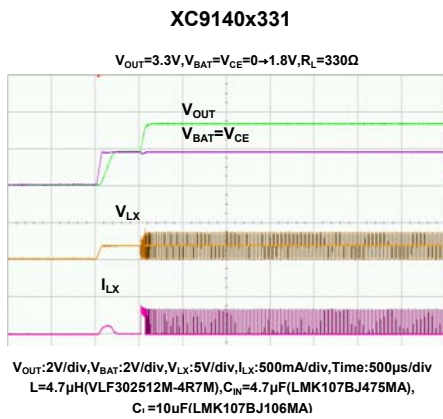

■ TYPICAL PERFORMANCE CHARACTERISTICS (Continued)

(24) Load Transient Response

XC9140x181

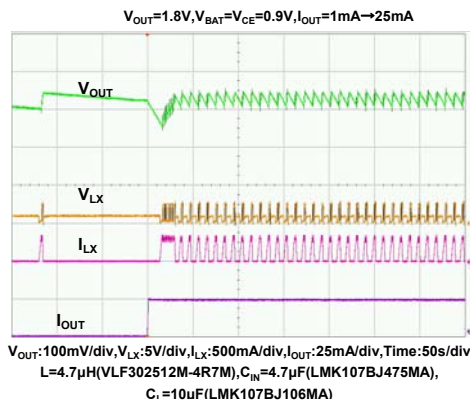

XC9140x181

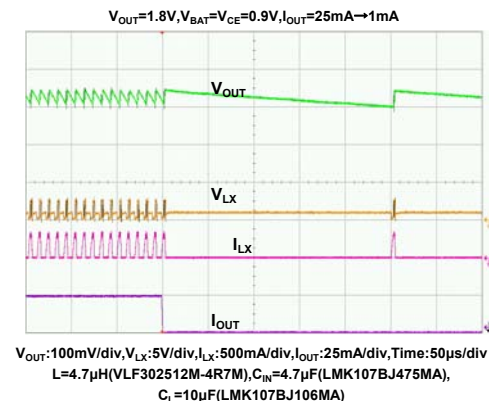

XC9140x331

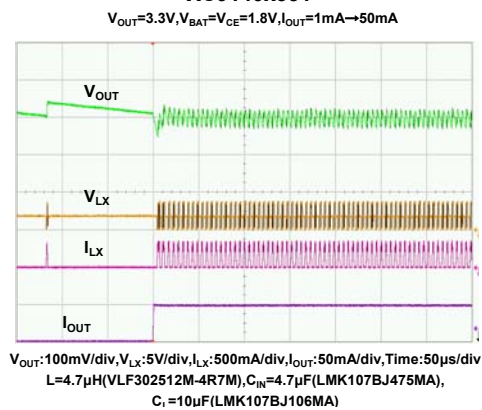

XC9140x331

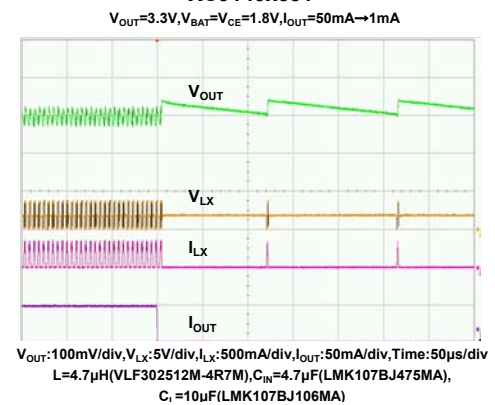

XC9140x501

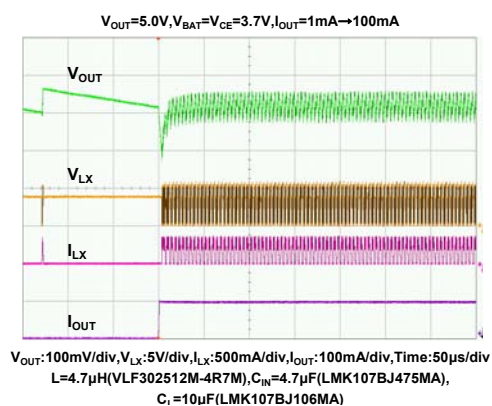

XC9140x501

