



Chipsmall Limited consists of a professional team with an average of over 10 year of expertise in the distribution of electronic components. Based in Hongkong, we have already established firm and mutual-benefit business relationships with customers from,Europe,America and south Asia,supplying obsolete and hard-to-find components to meet their specific needs.

With the principle of “Quality Parts,Customers Priority,Honest Operation,and Considerate Service”,our business mainly focus on the distribution of electronic components. Line cards we deal with include Microchip,ALPS,ROHM,Xilinx,Pulse,ON,Everlight and Freescale. Main products comprise IC,Modules,Potentiometer,IC Socket,Relay,Connector.Our parts cover such applications as commercial,industrial, and automotives areas.

We are looking forward to setting up business relationship with you and hope to provide you with the best service and solution. Let us make a better world for our industry!



Contact us

Tel: +86-755-8981 8866 Fax: +86-755-8427 6832

Email & Skype: info@chipsmall.com Web: www.chipsmall.com

Address: A1208, Overseas Decoration Building, #122 Zhenhua RD., Futian, Shenzhen, China



DC-6.0 GHz 1.0W Packaged HFET

Features

- ✕ 46.5 dBm OIP3 @ 5.8 GHz
- ✕ 15.5 dB Gain @ 2 GHz
- ✕ 10.0 dB Gain @ 6 GHz
- ✕ 30.0 dBm P1dB
- ✕ SOT-89 Package

General Description

The XF1001-SC is a high linearity Hetrojunction Field Effect Transistor (HFET) housed in an industry standard SOT-89 package. Optimum performance is achieved when the device is biased at a drain voltage of 8V and drain current of 300mA. At this bias point, the device is capable of more than 30 dBm of P1dB and OIP3 of more than 46 dBm. The XF1001-SC is suitable for applications up to 6 GHz where it has 10 dB of gain.

Typical Performance: 8V, 25 °C

Parameter	Typical		Units
Frequency (F)	1900	5800	MHz
Gain (S21)	15.5	10.1	dB
Output IP3 (OIP3)	46.5	46.5	dBm
Output P1dB	30.0	30.0	dBm
Quiescent Current (Idq)	300	300	mA
Input Return Loss (S11)	-12.5	-22.5	dB
Output Return Loss (S22)	-7.5	-7.5	dB
Noise Figure (NF)	4.5	5.0	dB

P1dB at 5900 MHz can be improved to over 30 dBm at the expense of gain.

Functional Block Diagram

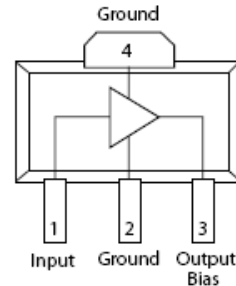

Absolute Maximum Ratings

Device Voltage (Vcc)	+9.0 V
Current (Icc)	450 mA
Power Dissipation (PDC)	4.5W
RF Input Power (RFIn)	+24 dBm
Junction Temperature	175 °C
Thermal Resistance	30 °C/W
Storage Temperature (Tstg)	-55 °C to +150 °C
Operating Temperature	-40 °C to +85 °C
ESD (HBM)	Class 1A
Moisture Sensitivity Level (MSL)	MSL 1

Operation of this device beyond any of these parameters may cause permanent damage.

Electrical Characteristics (T=25°C, Vd=8V)

Unless otherwise specified, the following specifications are guaranteed at room temperature in a Mimix test fixture.

Parameter	Condition	Units	Min	Typ	Max
Frequency Range (F)		MHz	DC		6000
Test Frequency		MHz		1900	
Small Signal Gain (S21)	Externally matched	dB	13.5	15.5	
Output Intercept Point (OIP3)	Pout/Tone=13 dBm, Spacing=5 MHz	dBm	+44.0	+46.5	
Output P1dB		dBm	+29.0	+30.0	
Quiescent Current (Icq)		mA		300.0	330.0
Gate Voltage		V	-1.2	-0.85	-0.5
Noise Figure (NF)		dB		4.5	

DC-6.0 GHz 1.0W Packaged HFET

April 2010 - Rev 05-Apr-10

Mimix
BROADBAND™

✕ F1001-SC
✕ RoHS

Evaluation Board: EVI, 5.8 GHz

$V_g = -0.85V$ $V_d = 8V$

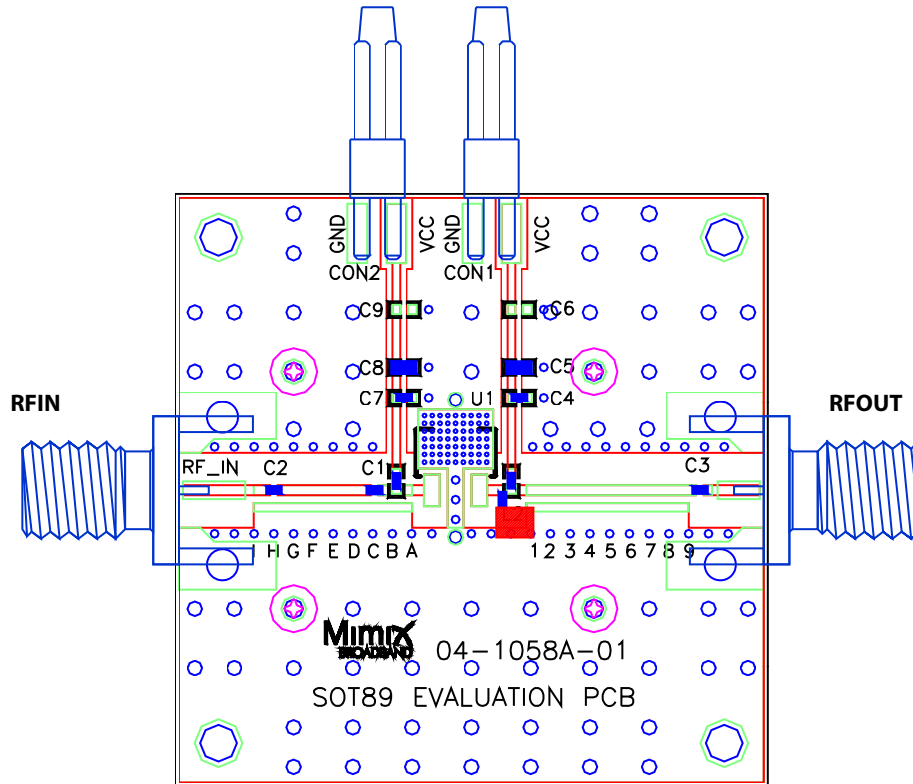

Dielectric: Rogers 4003
Thickness: 12mil

Schematic: EVI, 5.8 GHz

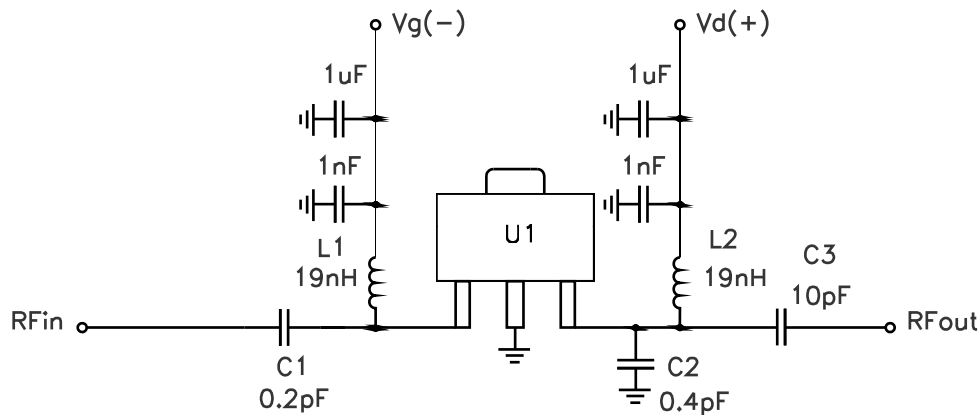

Mimix Broadband, Inc., 10795 Rockley Rd., Houston, Texas 77099
Tel: 281.988.4600 Fax: 281.988.4615 mimixbroadband.com

Page 2 of 7

Characteristic Data and Specifications are subject to change without notice. ©2010 Mimix Broadband, Inc.
Export of this item may require appropriate export licensing from the U.S. Government. In purchasing these parts, U.S. Domestic customers accept their obligation to be compliant with U.S. Export Laws.

DC-6.0 GHz 1.0W Packaged HFET

April 2010 - Rev 05-Apr-10



F1001-SC
RoHS

Typical Performance: 5.8 GHz

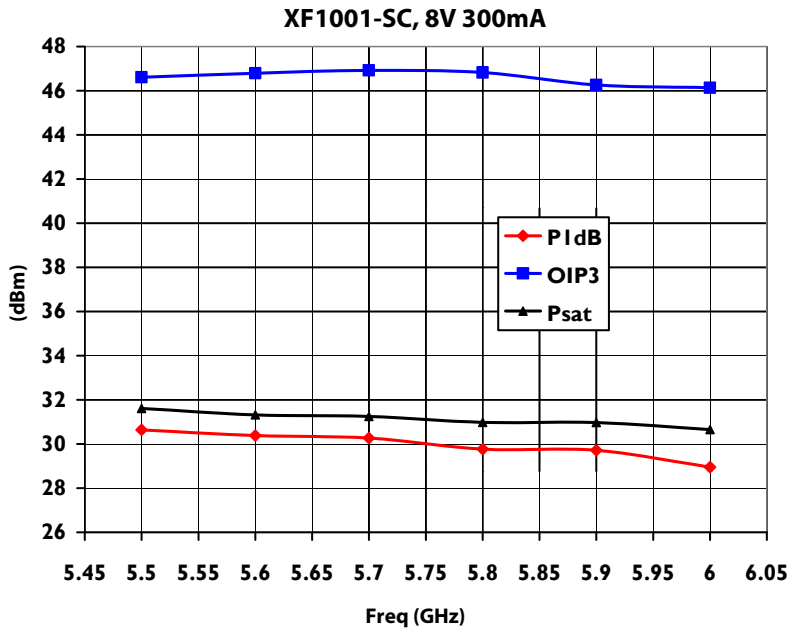
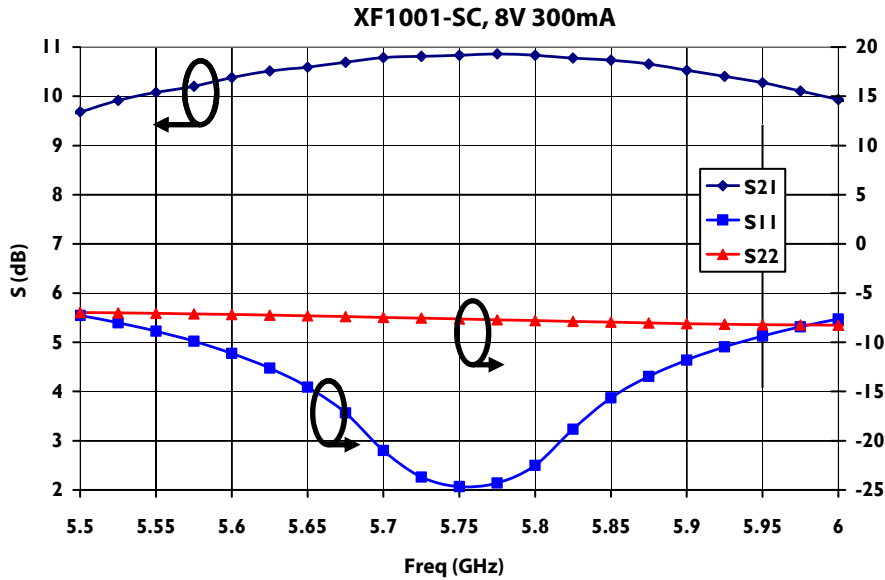

DC-6.0 GHz 1.0W Packaged HFET

April 2010 - Rev 05-Apr-10



Typical Performance: 5.8 GHz (over temperature)

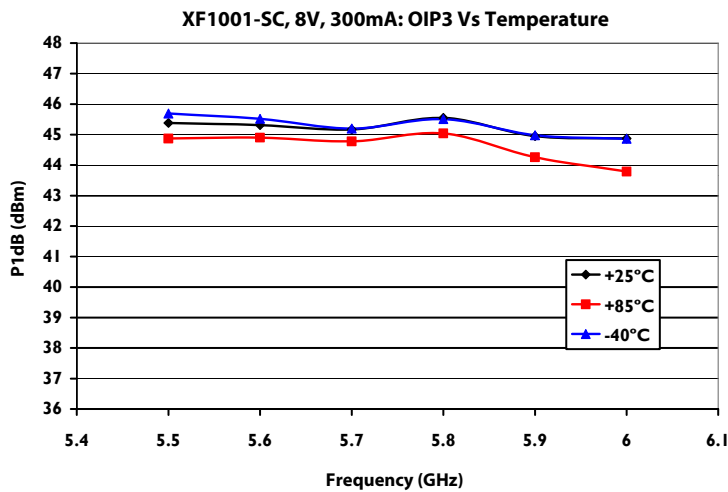
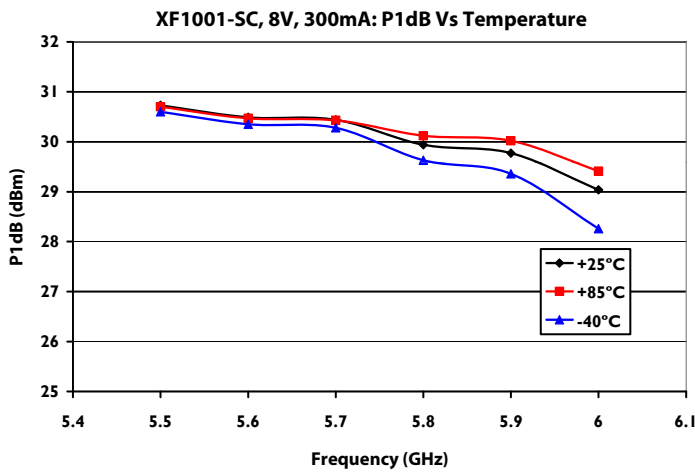
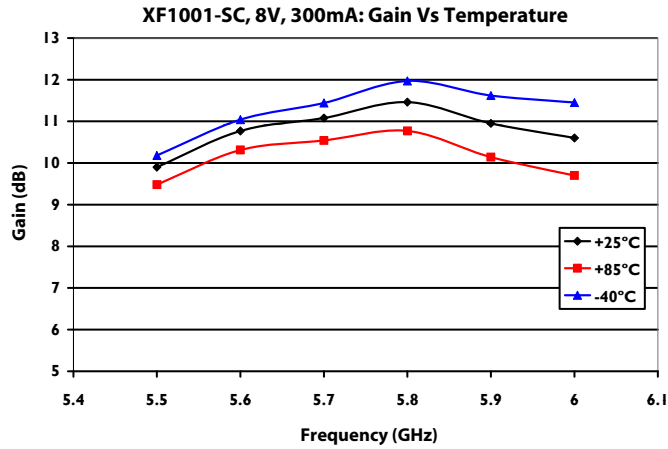

DC-6.0 GHz 1.0W Packaged HFET

April 2010 - Rev 05-Apr-10



Typical Performance: 1.9 GHz

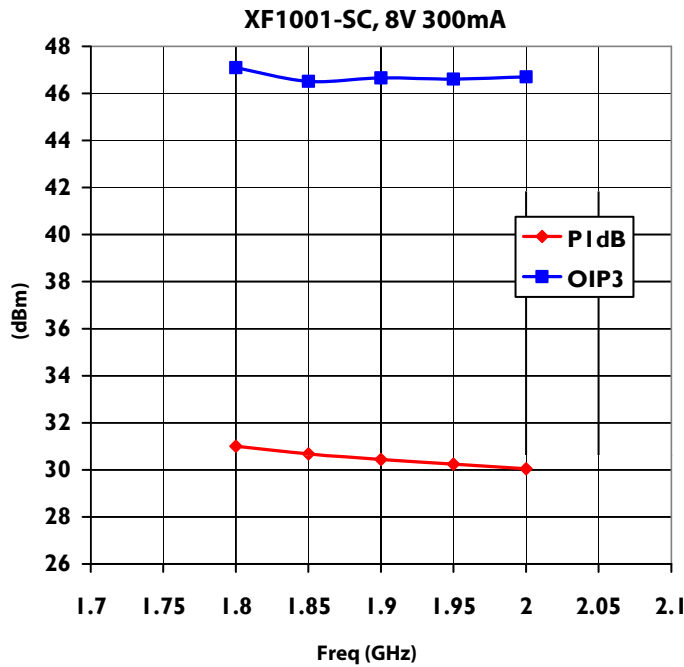
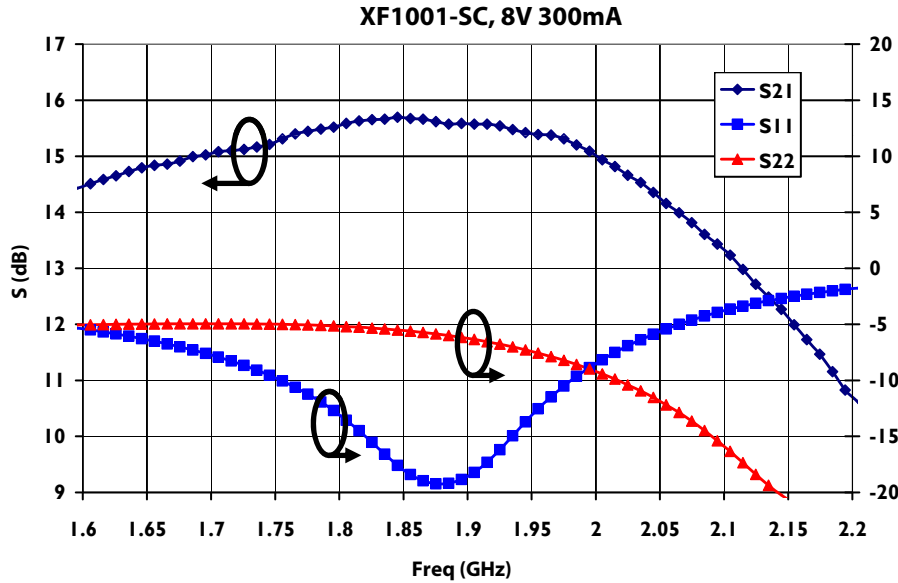

DC-6.0 GHz 1.0W Packaged HFET

April 2010 - Rev 05-Apr-10

App Note [1] Biasing - The XF1001-SC requires power supply sequencing. Negative voltage supply (V_{gg}) needs to be turned on first and then positive voltage can be applied to the drain (V_{dd}). When turning off the device, the positive supply (V_{dd}) should be turned off first and then negative voltage (V_{gg}) can be removed.

The gate voltage is adjusted in order to set the drain current to the desired level. The gate voltage required to achieve a certain current can vary over temperature and from one device to another due to pinch-off voltage variation. Constant drain current can be achieved by implementing an active bias circuit which allows for temperature compensation and eliminates the effect of pinch off voltage variation.

Physical Dimensions

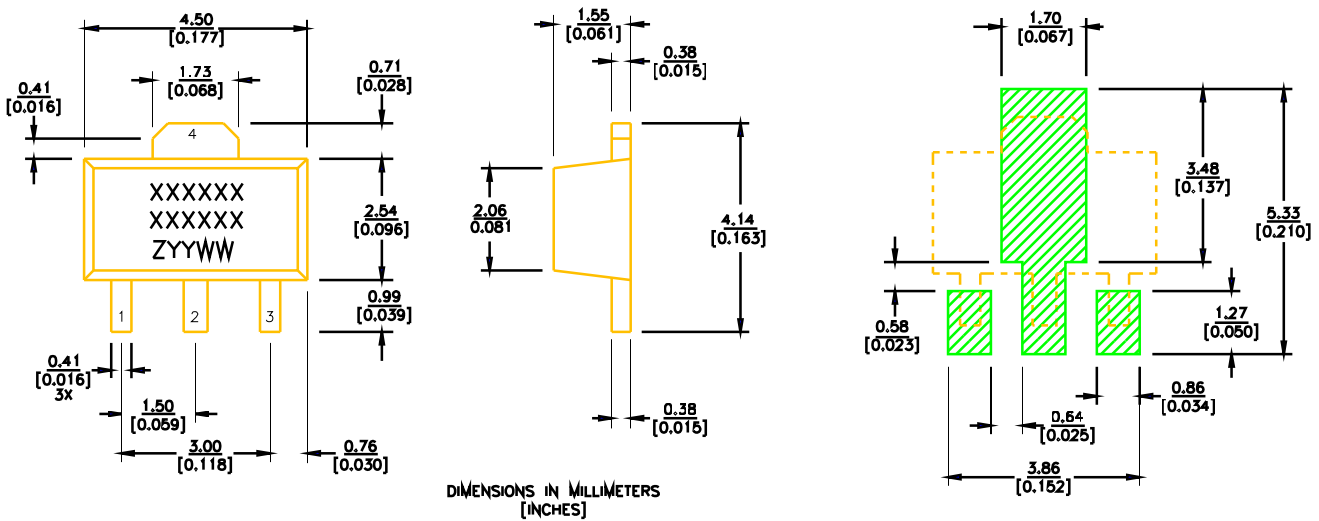

MARKINGS:
 XXXXXX = MODEL NO.
 XXXXXX = WAFER LOT NO.
 ZYYWW = DATE COSE (YR/WEEK)
 FIRST LETTER COUNTRY OF ORIGIN IF OTHER THAN USA

Pin-out Details

Description	Pin #
RF Input	1
RF Output	3
GND	2, 4

DC-6.0 GHz 1.0W Packaged HFET

April 2010 - Rev 05-Apr-10

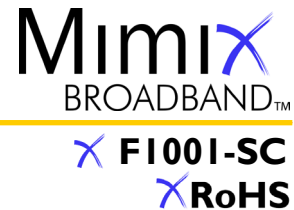

Handling and Assembly Information

CAUTION! - Mimix Broadband MMIC Products contain gallium arsenide (GaAs) which can be hazardous to the human body and the environment. For safety, observe the following procedures:

- Do not ingest.
- Do not alter the form of this product into a gas, powder, or liquid through burning, crushing, or chemical processing as these by-products are dangerous to the human body if inhaled, ingested, or swallowed.
- Observe government laws and company regulations when discarding this product. This product must be discarded in accordance with methods specified by applicable hazardous waste procedures.

Life Support Policy - Mimix Broadband's products are not authorized for use as critical components in life support devices or systems without the express written approval of the President and General Counsel of Mimix Broadband. As used herein: (1) Life support devices or systems are devices or systems which, (a) are intended for surgical implant into the body, or (b) support or sustain life, and whose failure to perform when properly used in accordance with instructions for use provided in the labeling, can be reasonably expected to result in a significant injury to the user. (2) A critical component is any component of a life support device or system whose failure to perform can be reasonably expected to cause the failure of the life support device or system, or to affect its safety or effectiveness.

Package Attachment - This packaged product from Mimix Broadband is provided as a rugged surface mount package compatible with high volume solder installation. Care should be taken not to apply heavy pressure to the top or base material to avoid package damage. Vacuum tools or other suitable pick and place equipment may be used to pick and place this part. Care should be taken to ensure that there are no voids or gaps in the solder connection so that good RF, DC and ground connections are maintained. Voids or gaps can eventually lead not only to RF performance degradation, but reduced reliability and life of the product due to thermal stress.

Mimix Lead-Free RoHS Compliant Program - Mimix has an active program in place to meet customer and governmental requirements for eliminating lead (Pb) and other environmentally hazardous materials from our products. All Mimix RoHS compliant components are form, fit and functional replacements for their non-RoHS equivalents. Lead plating of our RoHS compliant parts is 100% matte tin (Sn) over copper alloy and is backwards compatible with current standard SnPb low-temperature reflow processes as well as higher temperature (260°C reflow) "Pb Free" processes.

Ordering Information

Part Number for Ordering	Description
XF1001-SC-0G00	Matte Tin plated RoHS compliant SOT-89 surface mount package in bulk quantity
XF1001-SC-0G0T	Matte Tin plated RoHS compliant SOT-89 surface mount package in tape and reel
XF1001-SC-EV1	Evaluation Board @ 5800 MHz



Proper ESD procedures should be followed when handling this device.

Mimix Broadband, Inc., 10795 Rockley Rd., Houston, Texas 77099
Tel: 281.988.4600 Fax: 281.988.4615 mimixbroadband.com

Page 7 of 7

Characteristic Data and Specifications are subject to change without notice. ©2010 Mimix Broadband, Inc.
Export of this item may require appropriate export licensing from the U.S. Government. In purchasing these parts, U.S. Domestic customers accept their obligation to be compliant with U.S. Export Laws.