



Chipsmall Limited consists of a professional team with an average of over 10 year of expertise in the distribution of electronic components. Based in Hongkong, we have already established firm and mutual-benefit business relationships with customers from,Europe,America and south Asia,supplying obsolete and hard-to-find components to meet their specific needs.

With the principle of “Quality Parts,Customers Priority,Honest Operation,and Considerate Service”,our business mainly focus on the distribution of electronic components. Line cards we deal with include Microchip,ALPS,ROHM,Xilinx,Pulse,ON,Everlight and Freescale. Main products comprise IC,Modules,Potentiometer,IC Socket,Relay,Connector.Our parts cover such applications as commercial,industrial, and automotives areas.

We are looking forward to setting up business relationship with you and hope to provide you with the best service and solution. Let us make a better world for our industry!



Contact us

Tel: +86-755-8981 8866 Fax: +86-755-8427 6832

Email & Skype: info@chipsmall.com Web: www.chipsmall.com

Address: A1208, Overseas Decoration Building, #122 Zhenhua RD., Futian, Shenzhen, China



Screw Mount Eliminated to Save Space. Adjustable Stacking Space of 12 to 20 mm Adds Greater Flexibility.

- The stacking space can be adjusted from 12 to 20 mm in 1-mm increments.
- A pitch of 1.27 mm for high-density mounting in double-row arrangements.
- A quadruple-row staggered arrangement (1.27 x 1.905 mm) for board connection.
- All models incorporate fastening pins to secure the terminals, thus preventing floating or falling over during soldering.
- Leaf contact construction enables smooth mating and resistance to bending.
- Space saving mating length of 3.1 mm.
- Press fitting assures long-term contact quality. The gold/palladium plating has been improved for better contact reliability.
- The XH3 conforms to UL standards (file No. E103202).
- Not mated with XH2 and XH4 Half-pitch Connectors.

RoHS Compliant

Terminology

• Standard

To vertically connect the printed-wiring board, connect the socket straight terminal connector to the mother board (main board) side and connect the plug right-angle terminal connector to the daughter board (sub board) side.

• Reverse

To vertically connect the printed-wiring board, connect the plug straight terminal connector to the mother board (main board) side and connect the socket right-angle terminal connector to the daughter board (sub board) side.

• Stacking

Connects the printed-wiring boards parallel to each other. The distance between the boards here is called "stacking height".

• Horizontal

Connect the printed-wiring boards horizontally.

• Leaf contact construction

In this structure, contacts are protected by the housing.

Mating figure of the XH3A/XH3B

The contacts are protected by the housing when mated so that they do not readily deform.

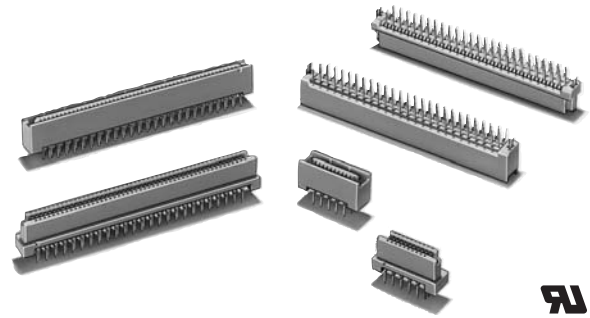
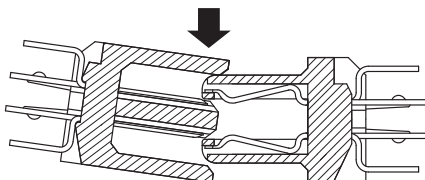

Ratings and Characteristics

Rated current	0.5 A
Rated voltage	125 VAC
Contact resistance (See note.)	30 mΩ max. (20 mV max., 100 mA max.)
Insulation resistance	1,000 MΩ min. (at 500 VDC)
Dielectric strength	650 VAC for 1 min (leakage current: 1 mA max.)
Total insertion force	0.78 N max. per contact
Total removal force	0.10 N min. per contact
Insertion durability	400 times
Ambient operating temperature	-55 to 105°C (with no condensation or icing)

Note: The contact resistance is for the XH3A-□□41 combined with the XH3B-□□41.

Materials and Finish

Item	Type	Plug	Socket
Housing		PBT (UL94 V-0)/gray	
Locator		PBT (UL94 V-0)/gray	
Contacts	Mating end	Phosphor bronze/nickel base, gold/palladium plating	Phosphor bronze/nickel base, gold/palladium plating
	Terminal	Phosphor bronze/nickel base, tin plating	Phosphor bronze/nickel base, tin plating
Fastening pins		Copper alloy/tin plating	

XH3A Plug, Straight DIP Terminals

■ Dimensions

(unit: mm)

XH3A-□□41
(Straight DIP Terminals)

XH3A-□□41-A
(Straight DIP Terminals
with Fastening Pins)

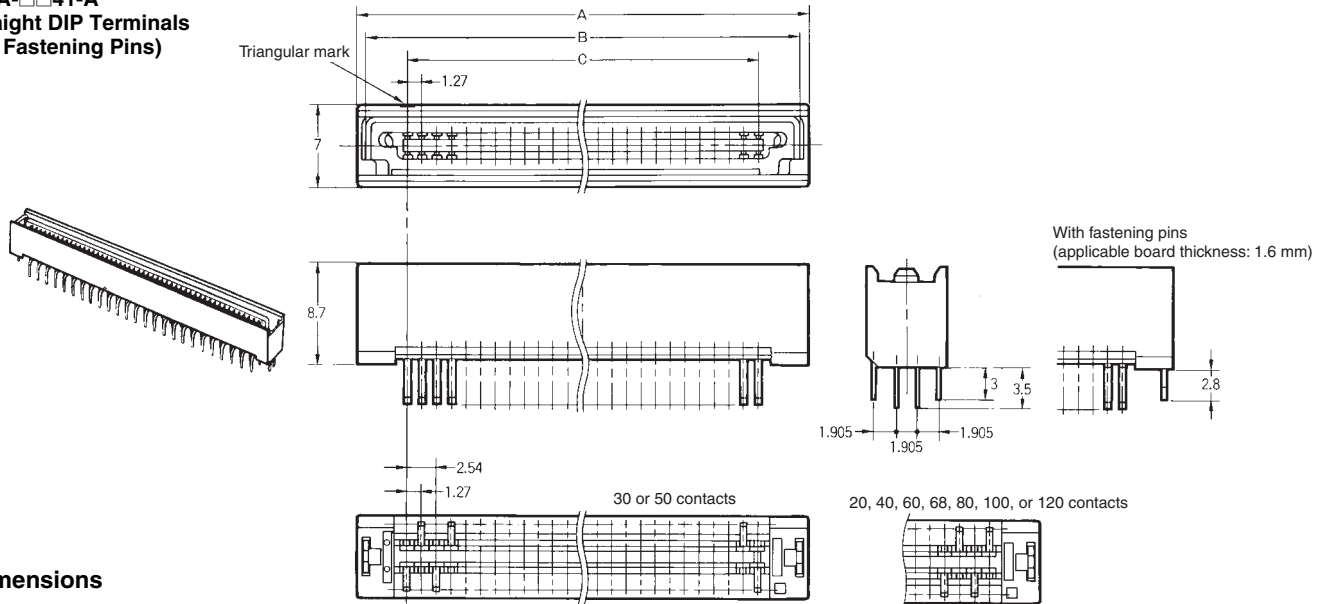

Dimensions

Dimensions (mm)	A	B	C	D
No. of contacts				
20	20.0	18.7	11.43	18.54
30	26.4	25.1	17.78	24.89
40	32.7	31.4	24.13	31.24
50	39.1	37.8	30.48	37.59
60	45.4	44.1	36.83	43.94
68	50.5	49.2	41.91	49.02
80	58.1	56.8	49.53	56.64
100	70.8	69.5	62.23	69.34
120	83.5	82.2	74.93	82.04

Reference

Mounting holes (bottom view)

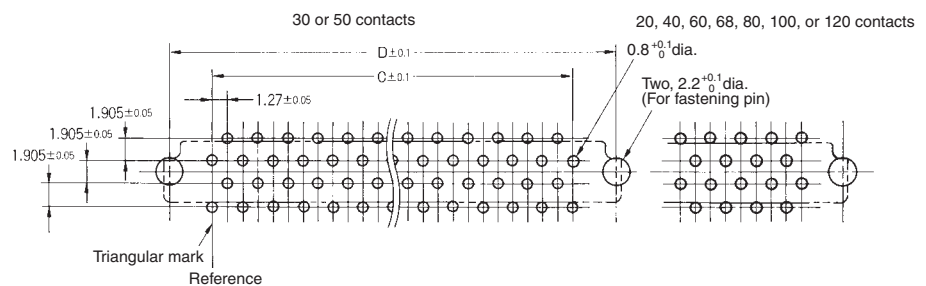

Reference

■ Ordering Information

Model	Plug/Straight DIP Terminals	Plug/Straight DIP Terminals with fastening pins (See note.)
No. of contacts		
20	XH3A-2041	XH3A-2041-A
30	XH3A-3041	XH3A-3041-A
40	XH3A-4041	XH3A-4041-A
50	XH3A-5041	XH3A-5041-A
60	XH3A-6041	XH3A-6041-A
68	XH3A-6841	XH3A-6841-A
80	XH3A-8041	XH3A-8041-A
100	XH3A-0141	XH3A-0141-A
120	XH3A-0241	XH3A-0241-A

Note: Applicable board thickness is 1.6 mm.

XH3A Plug, Straight DIP Terminals

Stacking Space Adjustable in Increments of 2 or 4 mm

■ Dimensions

(unit: mm)

XH3A-□□41-2A (2-mm Increments)
(Straight DIP Terminals with Fastening Pins)

XH3A-□□41-4A (4-mm Increments)
(Straight DIP Terminals with Fastening Pins)

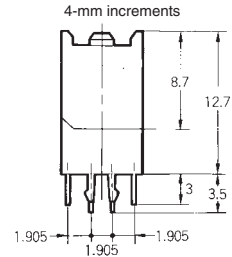
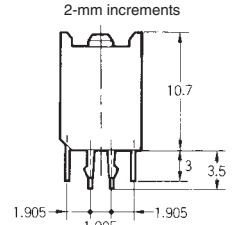
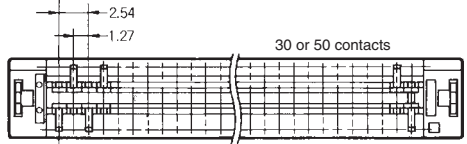
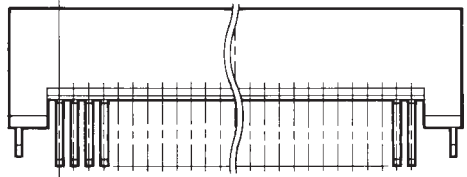
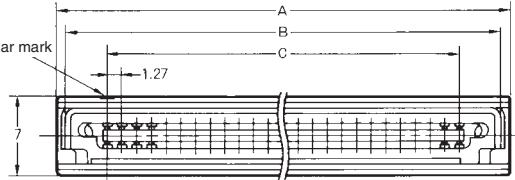
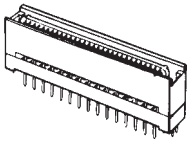

20, 40, 60, 68, 80, 100, or 120 contacts

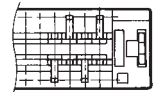

Dimensions

Dimensions (mm)	A	B	C	D
No. of contacts				
20	20.0	18.7	11.43	18.54
30	26.4	25.1	17.78	24.89
40	32.7	31.4	24.13	31.24
50	39.1	37.8	30.48	37.59
60	45.4	44.1	36.83	43.94
68	50.5	49.2	41.91	49.02
80	58.1	56.8	49.53	56.64
100	70.8	69.5	62.23	69.34
120	83.5	82.2	74.93	82.04

Reference Mounting holes (bottom view)

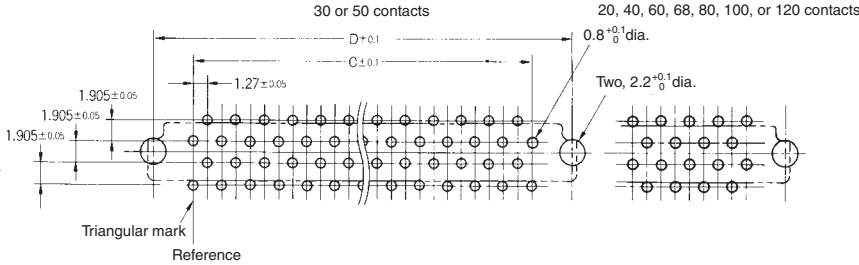

■ Ordering Information

No. of contacts	Model	Plug/Straight DIP Terminals with fastening pins (2-mm Increments) (See note.)	Plug/Straight DIP Terminals with fastening pins (4-mm Increments) (See note.)
20	XH3A-2041-2A	XH3A-2041-2A	XH3A-2041-4A
30	XH3A-3041-2A	XH3A-3041-2A	XH3A-3041-4A
40	XH3A-4041-2A	XH3A-4041-2A	XH3A-4041-4A
50	XH3A-5041-2A	XH3A-5041-2A	XH3A-5041-4A
60	XH3A-6041-2A	XH3A-6041-2A	XH3A-6041-4A
68	XH3A-6841-2A	XH3A-6841-2A	XH3A-6841-4A
80	XH3A-8041-2A	XH3A-8041-2A	XH3A-8041-4A
100	XH3A-0141-2A	XH3A-0141-2A	XH3A-0141-4A
120	XH3A-0241-2A	XH3A-0241-2A	XH3A-0241-4A

Note: Applicable board thickness is 1.6 mm.

XH3A Plug, Right-angle DIP Terminals

■ Dimensions

(unit: mm)

XH3-□□42-A
(Right-angle DIP Terminals with Fastening Pins)

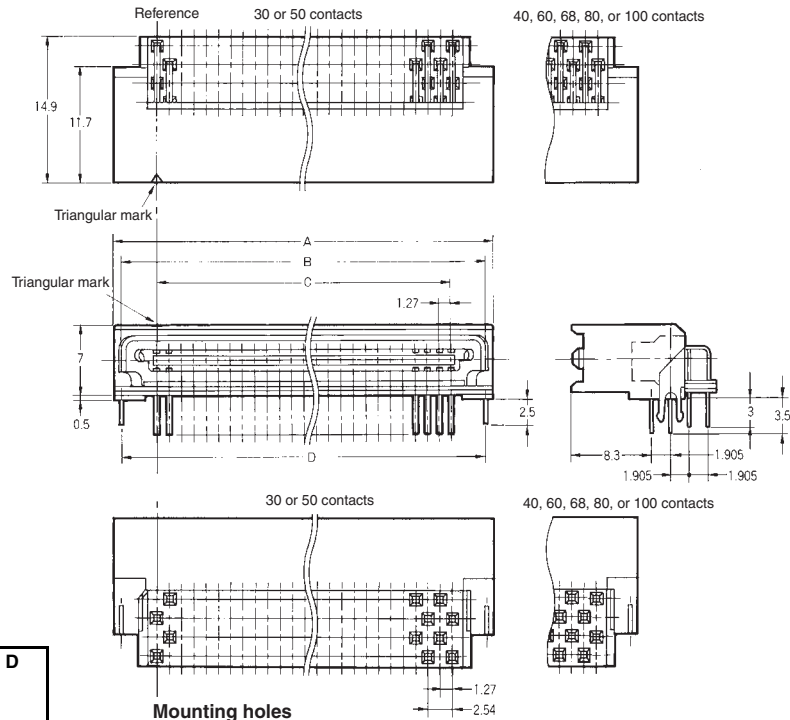
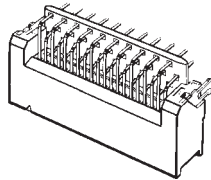

Dimensions

Dimensions (mm)	A	B	C	D
No. of contacts				
30	26.4	25.1	17.78	24.89
40	32.7	31.4	24.13	31.24
50	39.1	37.8	30.48	37.59
60	45.4	44.1	36.83	43.94
68	50.5	49.2	41.91	49.02
80	58.1	56.8	49.53	56.64
100	70.8	69.5	62.23	69.34

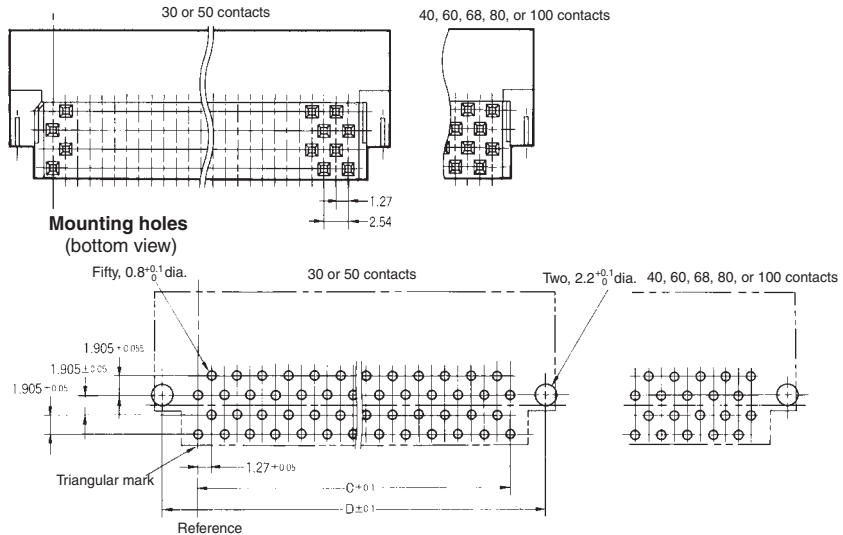

■ Ordering Information

Model	Plug/Right-angle DIP Terminals with fastening pins (See note.)
No. of contacts	
30	XH3A-3042-A
40	XH3A-4042-A
50	XH3A-5042-A
60	XH3A-6042-A
68	XH3A-6842-A
80	XH3A-8042-A
100	XH3A-0142-A

Note: Applicable board thickness is 1.6 mm.

XH3B Socket, Straight DIP Terminals

■ Dimensions

(unit: mm)

XH3B-□□41

(Straight DIP Terminals)

XH3B-□□41-A

(Straight DIP Terminals with Fastening Pins)

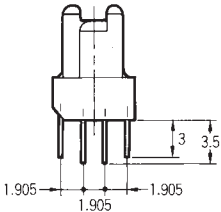
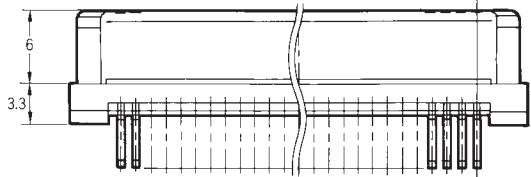
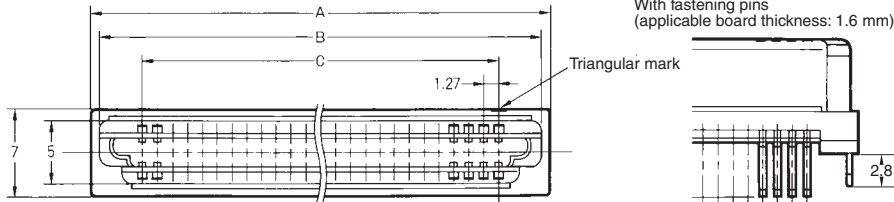
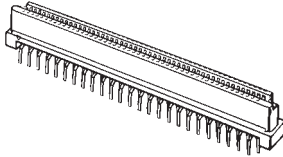

20, 40, 60, 68, 80, 100, or 120 contacts

30 or 50 contacts

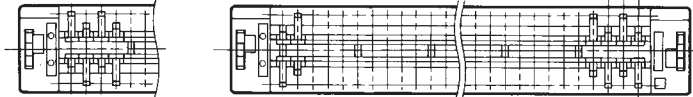

Reference

Dimensions

Dimensions (mm)	A	B	C	D
No. of contacts				
20	20.0	18.6	11.43	18.54
30	26.4	25.0	17.78	24.89
40	32.7	31.3	24.13	31.24
50	39.1	37.7	30.48	37.59
60	45.4	44.0	36.83	43.94
68	50.5	49.1	41.91	49.02
80	58.1	56.7	49.53	56.64
100	70.8	69.4	62.23	69.34
120	83.5	82.1	74.93	82.04

Mounting holes (bottom view)

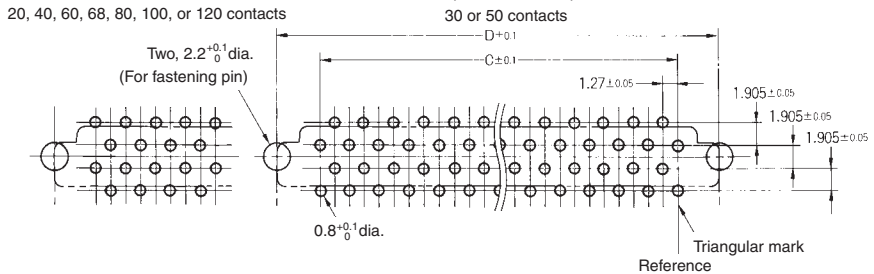

■ Ordering Information

Model	Socket/Straight DIP Terminals	Socket/Straight DIP Terminals with fastening pins (See note.)
No. of contacts		
20	XH3B-2041	XH3B-2041-A
30	XH3B-3041	XH3B-3041-A
40	XH3B-4041	XH3B-4041-A
50	XH3B-5041	XH3B-5041-A
60	XH3B-6041	XH3B-6041-A
68	XH3B-6841	XH3B-6841-A
80	XH3B-8041	XH3B-8041-A
100	XH3B-0141	XH3B-0141-A
120	XH3B-0241	XH3B-0241-A

Note: Applicable board thickness is 1.6 mm.

XH3B Socket, Straight DIP Terminals

Stacking Space Adjustable in Increments of 1, 3, and 4 mm

■ Dimensions

(unit: mm)

- XH3B-□□41-1A (1-mm Increment)
(Straight DIP Terminals with Fastening Pins)
- XH3B-□□41-3A (3-mm Increments)
(Straight DIP Terminals with Fastening Pins)
- XH3B-□□41-4A (4-mm Increments)
(Straight DIP Terminals with Fastening Pins)

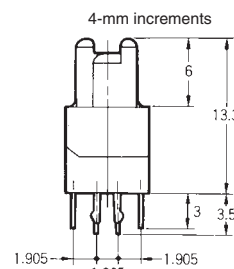
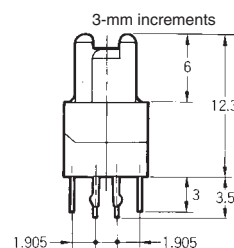
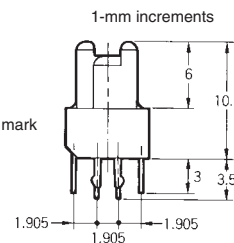
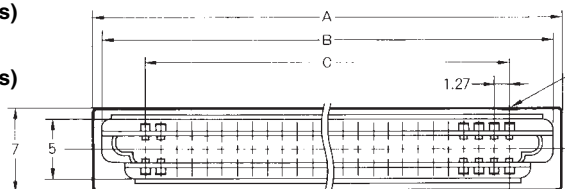
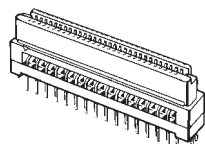

20, 40, 60, 68, 80, 100, or 120 contacts

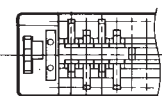

30 or 50 contacts

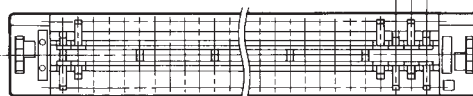

Dimensions

Dimensions (mm)	A	B	C	D
No. of contacts				
20	20.0	18.6	11.43	18.54
30	26.4	25.0	17.78	24.89
40	32.7	31.3	24.13	31.24
50	39.1	37.7	30.48	37.59
60	45.4	44.0	36.83	43.94
68	50.5	49.1	41.91	49.02
80	58.1	56.7	49.53	56.64
100	70.8	69.4	62.23	69.34
120	83.5	82.1	74.93	82.04

Mounting holes (bottom view)

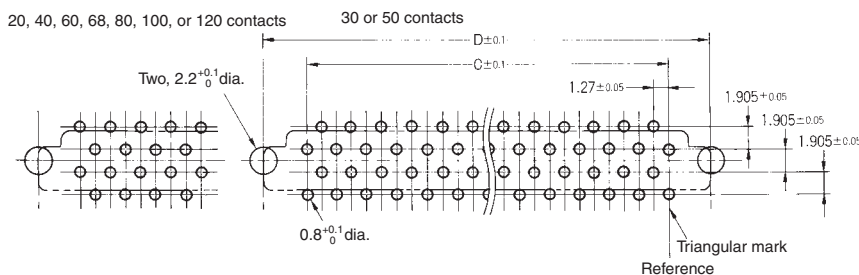

■ Ordering Information

No. of contacts	Model	Socket/Straight DIP Terminals with fastening pins (1-mm increment) (See note.)	Socket/Straight DIP Terminals with fastening pins (3-mm increments) (See note.)	Socket/Straight DIP Terminals with fastening pins (4-mm increments) (See note.)
20		XH3B-2041-1A	XH3B-2041-3A	XH3B-2041-4A
30		XH3B-3041-1A	XH3B-3041-3A	XH3B-3041-4A
40		XH3B-4041-1A	XH3B-4041-3A	XH3B-4041-4A
50		XH3B-5041-1A	XH3B-5041-3A	XH3B-5041-4A
60		XH3B-6041-1A	XH3B-6041-3A	XH3B-6041-4A
68		XH3B-6841-1A	XH3B-6841-3A	XH3B-6841-4A
80		XH3B-8041-1A	XH3B-8041-3A	XH3B-8041-4A
100		XH3B-0141-1A	XH3B-0141-3A	XH3B-0141-4A
120		XH3B-0241-1A	XH3B-0241-3A	XH3B-0241-4A

Note: Applicable board thickness is 1.6 mm.

XH3B Socket, Right-angle DIP Terminals

■ Dimensions

(unit: mm)

XH3B-□□42-A
(Right-angle DIP Terminals with Fastening Pins)

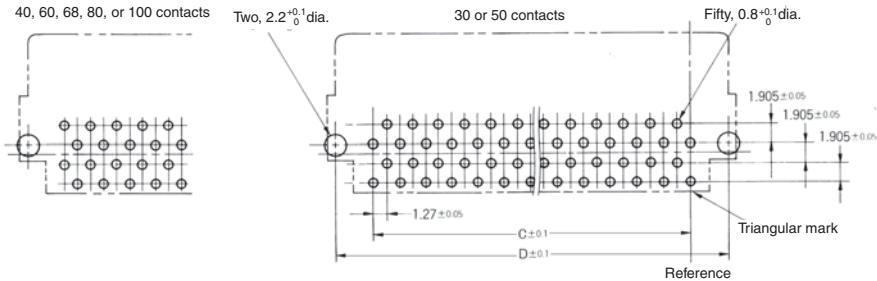
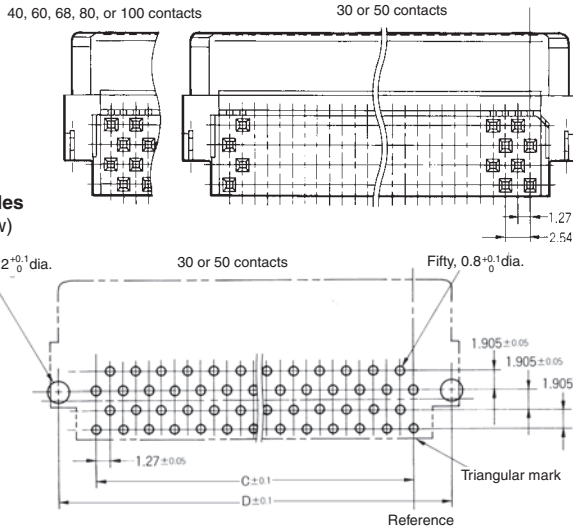
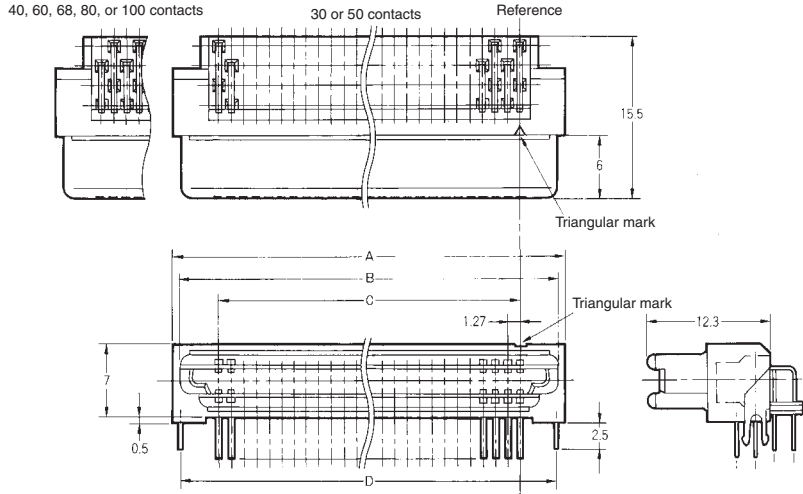
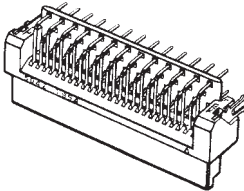

Dimensions

Dimensions (mm)	A	B	C	D
No. of contacts				
30	26.4	25.0	17.78	24.89
40	32.7	31.3	24.13	31.24
50	39.1	37.7	30.48	37.59
60	45.4	44.0	36.83	43.94
68	50.5	49.1	41.91	49.02
80	58.1	56.7	49.53	56.64
100	70.8	69.4	62.23	69.34

■ Ordering Information

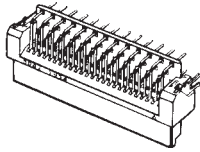
Model	Plug/Right-angle DIP Terminals with fastening pins (See note.)
	
No. of contacts	
30	XH3B-3042-A
40	XH3B-4042-A
50	XH3B-5042-A
60	XH3B-6042-A
68	XH3B-6842-A
80	XH3B-8042-A
100	XH3B-0142-A

Note: Applicable board thickness is 1.6 mm.

Mating Diagram

(unit: mm)

Vertical/Horizontal/Stacking

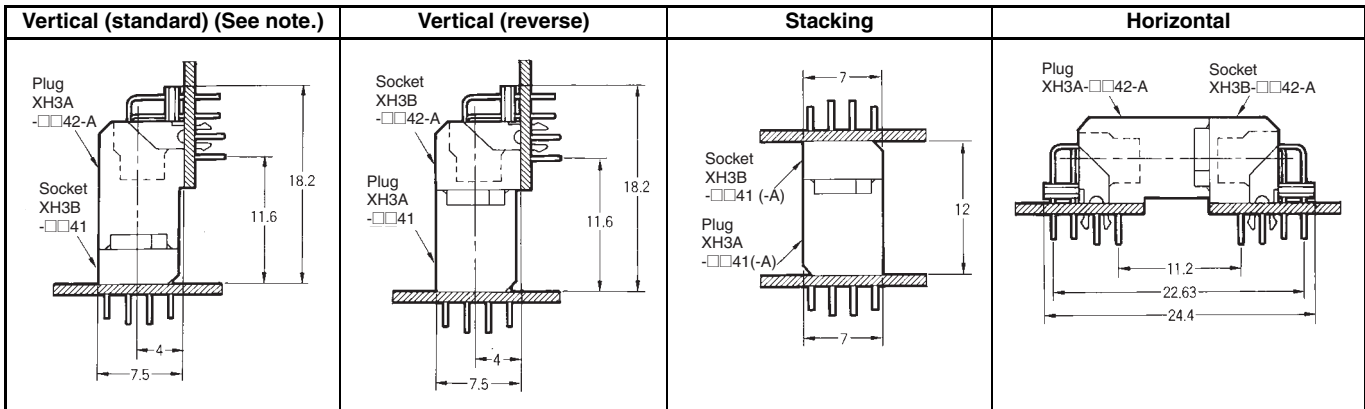

Note: The function of the standard and reverse models is the same as that of the standard XC5 DIN Connectors.

Stacking Space Adjustable Models

Stacking space	12 mm	13 mm	14 mm	15 mm	16 mm
Mating diagram					
Stacking space	17 mm	18 mm	19 mm	20 mm	
Mating diagram					

Combinations

Socket	XH3B-□□41 XH3B-□□41-A	1-mm increment XH3B-□□41-1A	3-mm increments XH3B-□□41-3A	4-mm increments XH3B-□□41-4A
Plug				
XH3A-□□41, XH3A-□□41-A	12 mm	13 mm	(15 mm) (See note.)	(16 mm) (See note.)
2-mm increment XH3A-□□41-2A	14 mm	15 mm	(17 mm) (See note.)	18 mm
4-mm increment XH3A-□□41-4A	16 mm	17 mm	19 mm	20 mm

Note: Combinations marked with parentheses must be avoided if possible.

Contact Numbers

Item	Mated diagram	Mounting holes (bottom view)
Model Plug, Straight Terminals		
Socket, Straight Terminals		

- Contact numbers are not printed on the connectors. Use the triangular mark (▼) as a guide when designing and mounting to boards.
- On the mating side, the row of terminals on the triangular mark side are called row a, and the row on the other side is called row b. The numbers are in the order shown.
- The triangular marks on the plug and socket must be aligned when mated. The contact numbers on both sides must match.

Precautions

Correct Use

Mating Compatibility

XH3 Half-pitch Connectors do not mate with XH2 or XH4 Half-pitch Connectors.

Flux Rise

These Connectors were designed for automatic soldering. If you use a foaming device or brush on flux from the front side, the amount of applied flux will increase and may cause flux rise. Do not use these methods to apply flux.

Soldering

Automated soldering

Use tape to mask the Right-angle Terminal Connector prior to automated soldering.

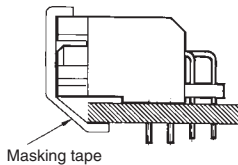

Automated Soldering Conditions (Jet Flow)

1. Soldering temperature: $250 \pm 5^\circ\text{C}$
2. Continuous soldering time: Within 5 ± 1 s (Be sure to wash the board after continuous soldering is completed.)

- Application examples provided in this document are for reference only. In actual applications, confirm equipment functions and safety before using the product.
- Consult your OMRON representative before using the product under conditions which are not described in the manual or applying the product to nuclear control systems, railroad systems, aviation systems, vehicles, combustion systems, medical equipment, amusement machines, safety equipment, and other systems or equipment that may have a serious influence on lives and property if used improperly. Make sure that the ratings and performance characteristics of the product provide a margin of safety for the system or equipment, and be sure to provide the system or equipment with double safety mechanisms.

Note: Do not use this document to operate the Unit.