



Chipsmall Limited consists of a professional team with an average of over 10 year of expertise in the distribution of electronic components. Based in Hongkong, we have already established firm and mutual-benefit business relationships with customers from,Europe,America and south Asia,supplying obsolete and hard-to-find components to meet their specific needs.

With the principle of “Quality Parts,Customers Priority,Honest Operation,and Considerate Service”,our business mainly focus on the distribution of electronic components. Line cards we deal with include Microchip,ALPS,ROHM,Xilinx,Pulse,ON,Everlight and Freescale. Main products comprise IC,Modules,Potentiometer,IC Socket,Relay,Connector.Our parts cover such applications as commercial,industrial, and automotives areas.

We are looking forward to setting up business relationship with you and hope to provide you with the best service and solution. Let us make a better world for our industry!



Contact us

Tel: +86-755-8981 8866 Fax: +86-755-8427 6832

Email & Skype: info@chipsmall.com Web: www.chipsmall.com

Address: A1208, Overseas Decoration Building, #122 Zhenhua RD., Futian, Shenzhen, China



10.0-33.0 GHz Image Reject Mixer QFN, 4x4 mm

Features

- ✕ Fundamental Image Reject Mixer
- ✕ 9.0 dB Conversion Loss
- ✕ 20.0 dB Image Rejection
- ✕ +25.0 dBm Input Third Order Intercept (IIP3)
- ✕ 4x4 mm, QFN -- ROHS Compliant



General Description

Mimix Broadband's 10.0-33.0 GHz GaAs MMIC fundamental image reject mixer with high linearity has a conversion loss of 9.0 dB with a 20.0 dB image rejection across the band. I and Q mixer outputs are provided and an external 90 degree hybrid is required to select the desired sideband. This MMIC uses Mimix Broadband's 0.15 μm GaAs PHEMT device model technology, and is based upon electron beam lithography to ensure high repeatability and uniformity. The device comes in a low-cost 4x4 mm QFN surface mount plastic package. This device is well suited for Millimeter-wave Point-to-Point Radio, LMDS, SATCOM and VSAT applications.

Absolute Maximum Ratings

Gate Bias Voltage (Vg)	+0.3 VDC
Input Power (RF Pin)	+20.0 dBm
Input Power (IF Pin)	+20.0 dBm
Storage Temperature (Tstg)	-65 to +165 °C
Operating Temperature (Ta)	-55 to +125 °C

Electrical Characteristics (Ambient Temperature T = 25° C)

Parameter	Units	Min.	Typ.	Max.
Frequency Range (RF)	GHz	10.0	-	33.0
Frequency Range (LO)	GHz	8.0	-	36.0
Frequency Range (IF)	GHz	DC	-	4.0
RF Return Loss (S11)	dB	-	10.0	-
IF Return Loss (S22)	dB	-	TBD	-
LO Return Loss (S33)	dB	-	TBD	-
Conversion Loss (S21)	dB	-	9.0	-
LO Input Drive (P _{LO})	dBm	12.0	15.0	18.0
Image Rejection	dBc	-	20.0	-
Isolation LO/RF	dB	-	16.0	-
Isolation LO/IF	dB	-	TBD	-
Isolation RF/IF	dB	-	TBD	-
Input Third Order Intercept (IIP3)	dBm	-	+25.0	-
Gate Bias Voltage (Vg1)	VDC	-2.0	-0.5	+0.1

10.0-33.0 GHz Image Reject Mixer

QFN, 4x4 mm

November 2007 - Rev 20-Nov-07

Mixer Measurements

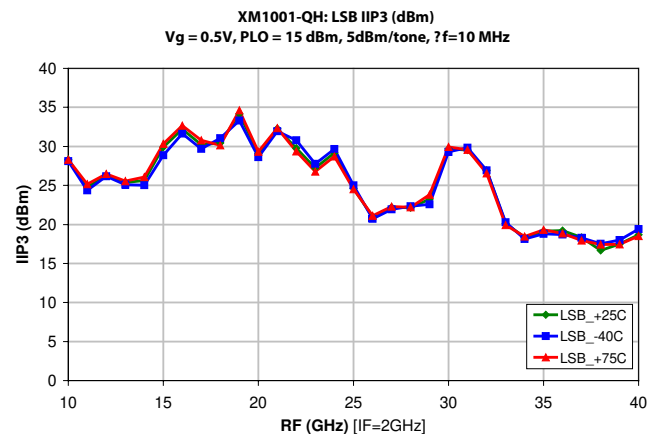
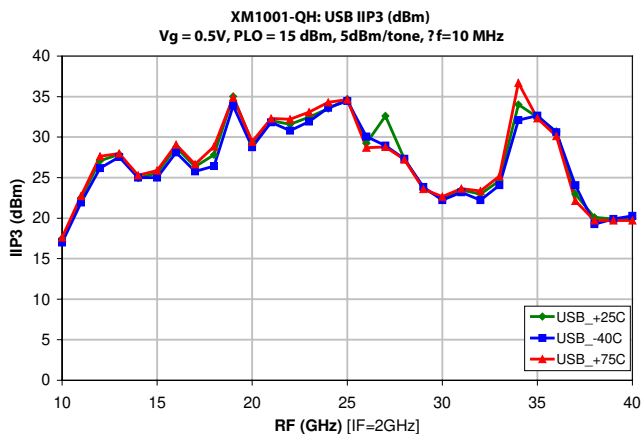
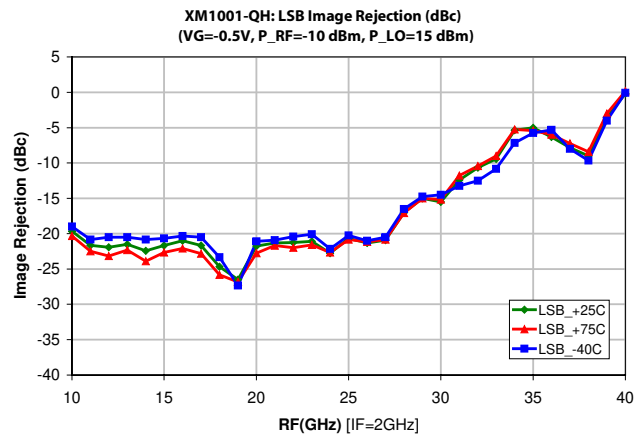
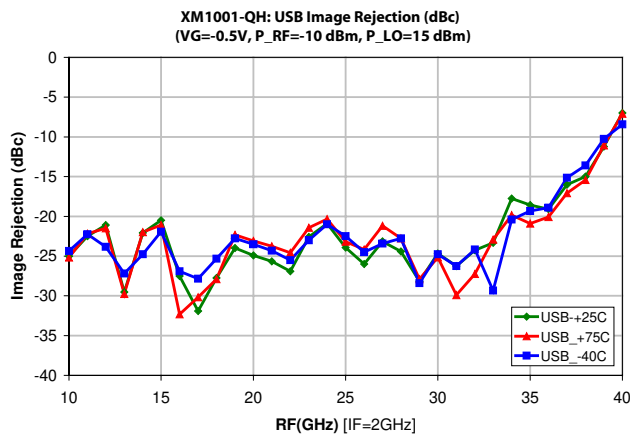
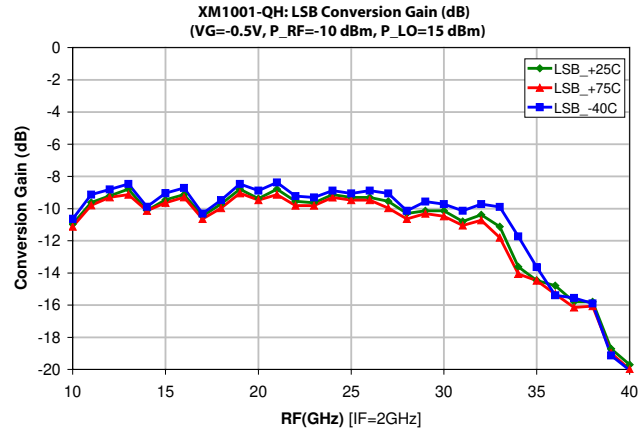
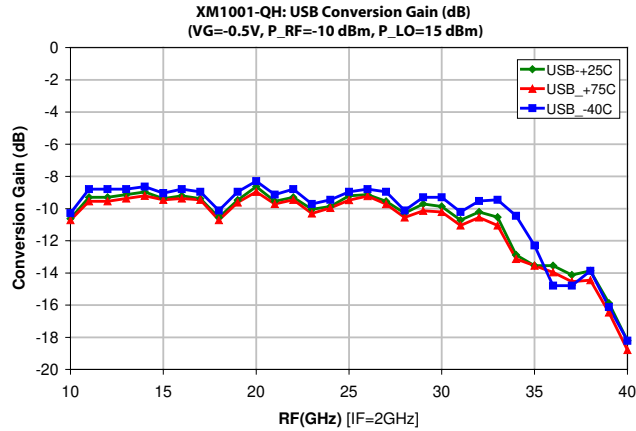

10.0-33.0 GHz Image Reject Mixer QFN, 4x4 mm

November 2007 - Rev 20-Nov-07

Mixer Measurements (cont.)

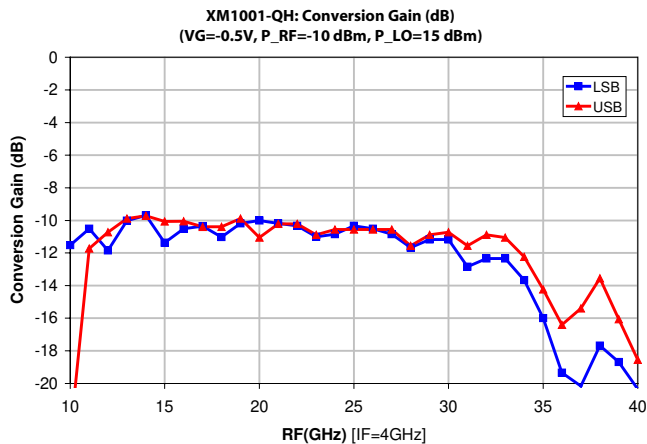
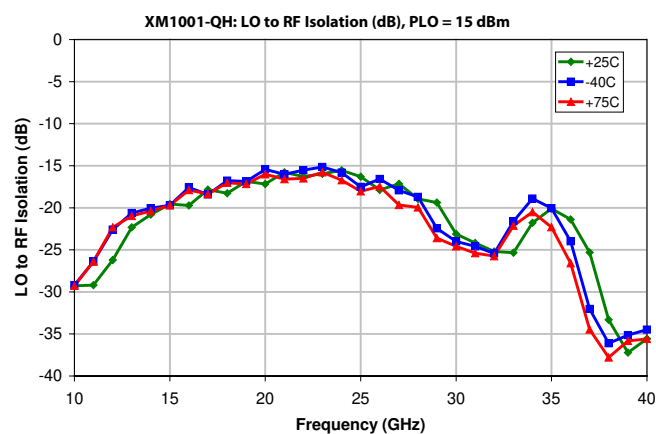

10.0-33.0 GHz Image Reject Mixer QFN, 4x4 mm

November 2007 - Rev 20-Nov-07

Physical Dimensions

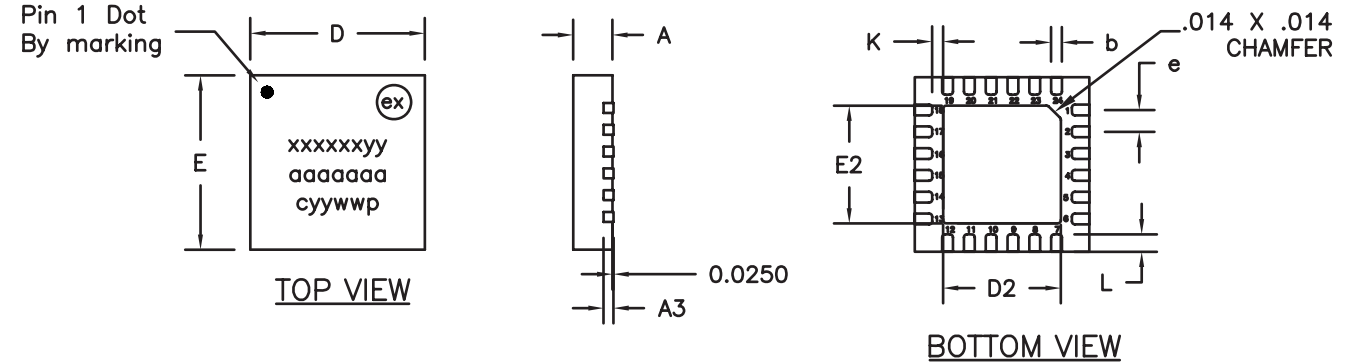

RECOMMENDED SOLDER PAD PITCH AND DIMENSIONS

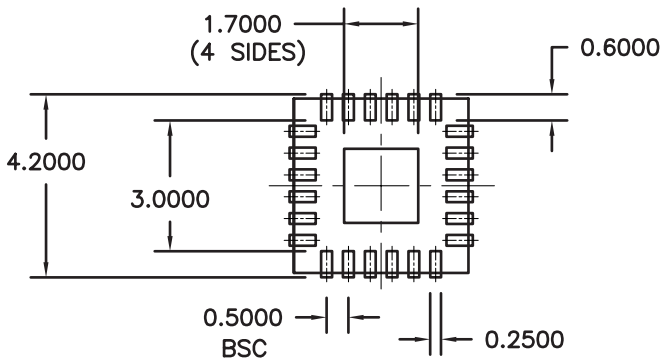

(Note: Engineering designator is 20IRRFM0374)

Note:

1. ALL DIMENSIONS ARE IN mm.

	MIN	TYP	MAX
A	0.80	0.90	1.00
A3	0.20 REF		
b	0.20	0.25	0.30
K	0.20	-	-
D	4.00 BSC		
E	4.00 BSC		
e	0.50		
D2	2.45	2.60	2.75
E2	2.45	2.60	2.75
L	0.20	0.30	0.40

Functional Schematic

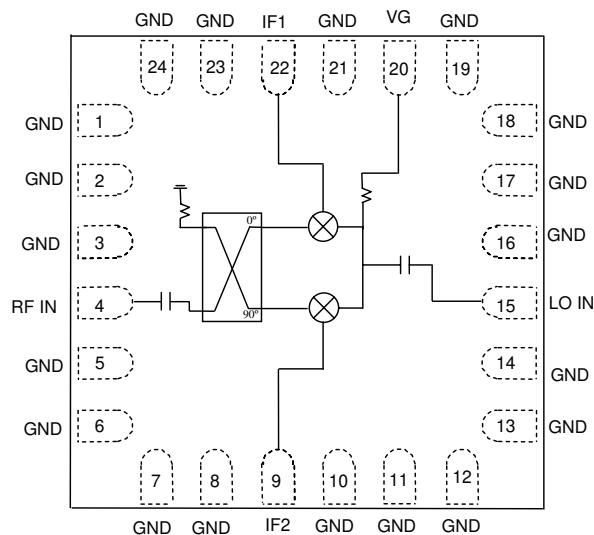

Pin Designations

Pin Number	Pin Name	Pin Function	Nominal Value	Units
1-3	GND	Ground		
4	RF IN	RF Input		
5-8	GND	Ground		
9	IF2	Output IF 1		
10-14	GND	Ground		
15	LO IN	LO Input		
16-19	GND	Ground		
20	VG	Gate bias	-0.5	Volts
21	GND	Ground		
22	IF2	Output IF 1		
23-24	GND	Ground		

10.0-33.0 GHz Image Reject Mixer QFN, 4x4 mm

App Note [3] USB/LSB Selection -

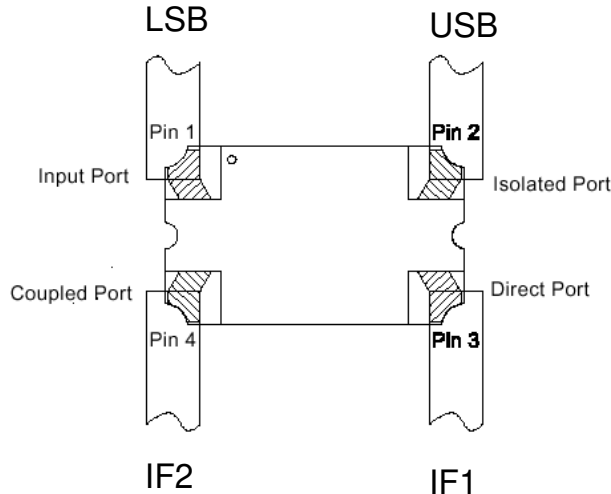

For Upper Side Band Operation (USB):

With IF1 and IF2 connected to the direct port (0°) and coupled port (90°) respectively as shown in the diagram, the USB signal will reside on the isolated port. The input port must be loaded with 50 ohms.

For Lower Side Band Operation (LSB):

With IF1 and IF2 connected to the direct port (0°) and coupled port (90°) respectively as shown in the diagram, the LSB signal will reside on the input port. The isolated port must be loaded with 50 ohms.

Note:

The coupled port can be used as an alternate input but the port location of the Coupled and Direct ports reverse.

An alternate method of Selection of USB or LSB:

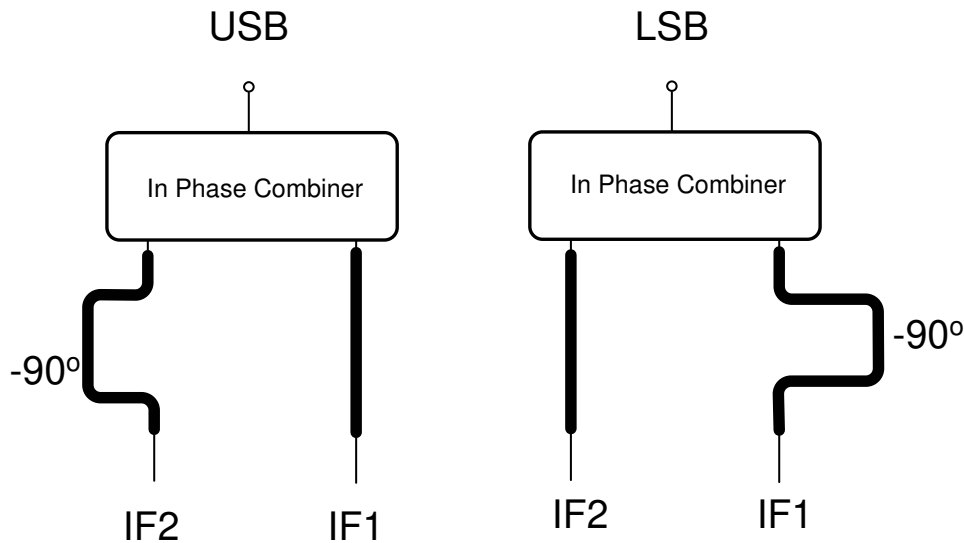

10.0-33.0 GHz Image Reject Mixer QFN, 4x4 mm

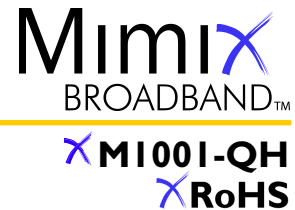

November 2007 - Rev 20-Nov-07

Handling and Assembly Information

CAUTION! - Mimix Broadband MMIC Products contain gallium arsenide (GaAs) which can be hazardous to the human body and the environment. For safety, observe the following procedures:

- Do not ingest.
- Do not alter the form of this product into a gas, powder, or liquid through burning, crushing, or chemical processing as these by-products are dangerous to the human body if inhaled, ingested, or swallowed.
- Observe government laws and company regulations when discarding this product. This product must be discarded in accordance with methods specified by applicable hazardous waste procedures.

Life Support Policy - Mimix Broadband's products are not authorized for use as critical components in life support devices or systems without the express written approval of the President and General Counsel of Mimix Broadband. As used herein: (1) Life support devices or systems are devices or systems which, (a) are intended for surgical implant into the body, or (b) support or sustain life, and whose failure to perform when properly used in accordance with instructions for use provided in the labeling, can be reasonably expected to result in a significant injury to the user. (2) A critical component is any component of a life support device or system whose failure to perform can be reasonably expected to cause the failure of the life support device or system, or to affect its safety or effectiveness.

Package Attachment - This packaged product from Mimix Broadband is provided as a rugged surface mount package compatible with high volume solder installation. The package is a low-cost plastic package. Vacuum tools or other suitable pick and place equipment may be used to pick and place this part. Care should be taken to ensure that there are no voids or gaps in the solder connection so that good RF, DC and ground connections are maintained. Voids or gaps can eventually lead not only to RF performance degradation, but reduced reliability and life of the product due to thermal stress.

Typical Reflow Profiles

Reflow Profile	SnPb	Pb Free
Ramp Up Rate	3-4 °C/sec	3-4 °C/sec
Activation Time and Temperature	60-120 sec @ 140-160 °C	60-180 sec @ 170-200 °C
Time Above Melting Point	60-150 sec	60-150 sec
Max Peak Temperature	240 °C	265 °C
Time Within 5 °C of Peak	10-20 sec	10-20 sec
Ramp Down Rate	4-6 °C/sec	4-6 °C/sec

Mimix Lead-Free RoHS Compliant Program - Mimix has an active program in place to meet customer and governmental requirements for eliminating lead (Pb) and other environmentally hazardous materials from our products. All Mimix RoHS compliant components are form, fit and functional replacements for their non-RoHS equivalents. Lead plating of our RoHS compliant parts is 100% matte tin (Sn) over copper alloy and is backwards compatible with current standard SnPb low-temperature reflow processes as well as higher temperature (260°C reflow) "Pb Free" processes.

Part Number for Ordering

Part Number for Ordering	Description
XM1001-QH-0G00	Matte Tin plated RoHS compliant QFN 4x4 24L surface mount package in bulk quantity
XM1001-QH-0G0T	Matte Tin plated RoHS compliant QFN 4x4 24L surface mount package in tape and reel
XM1001-QH-EV1	XM1001-QH Evaluation Board

We also offer this part with alternative plating. Please contact your regional sales manager for more information regarding different plating types.