



Chipsmall Limited consists of a professional team with an average of over 10 year of expertise in the distribution of electronic components. Based in Hongkong, we have already established firm and mutual-benefit business relationships with customers from,Europe,America and south Asia,supplying obsolete and hard-to-find components to meet their specific needs.

With the principle of “Quality Parts,Customers Priority,Honest Operation,and Considerate Service”,our business mainly focus on the distribution of electronic components. Line cards we deal with include Microchip,ALPS,ROHM,Xilinx,Pulse,ON,Everlight and Freescale. Main products comprise IC,Modules,Potentiometer,IC Socket,Relay,Connector.Our parts cover such applications as commercial,industrial, and automotives areas.

We are looking forward to setting up business relationship with you and hope to provide you with the best service and solution. Let us make a better world for our industry!



## Contact us

Tel: +86-755-8981 8866 Fax: +86-755-8427 6832

Email & Skype: info@chipsmall.com Web: www.chipsmall.com

Address: A1208, Overseas Decoration Building, #122 Zhenhua RD., Futian, Shenzhen, China



### Description

The **XR18910** is a unique sensor interface integrated circuit with an onboard 8:1 multiplexer, offset correction Digital-to-Analog Converter (DAC), instrumentation amplifier and voltage reference. The XR18910 is designed to integrate multiple bridge sensors with a Microcontroller (MCU) or Field-Programmable Gate Array (FPGA).

The integrated offset correction DAC provides digital calibration of the variable and in many cases substantial offset voltage generated by the bridge sensors. The DAC is controlled by an I<sup>2</sup>C compatible 2-wire serial interface. The serial interface also provides the user with easy controls to the XR18910's many functions such as input and gain selection.

A linear regulator (LDO) provides a regulated voltage to power the input bridge sensors and is selectable, between 3V and 2.65V. The LDO current can be sensed and a proportional voltage present at the output of the IC for monitoring the LDO current.

The XR18910 offers 8 fixed gain settings (from 2V/V to 760V/V), each with an error of only  $\pm 0.5\%$ , that are selectable via the I<sup>2</sup>C interface. It also offers less than 3mV maximum input offset voltage, 100pA maximum input bias current, and 100pA maximum input offset current.

The XR18910 is designed to operate from 2.7V to 5V supplies, specified over the industrial temperature range of -40°C to 85°C and is offered in a space saving 3.5mm x 3.5mm TQFN package. It consumes less than 559µA supply current and offers a sleep mode for added power savings.

The XR18910 is well suited for industrial and consumer applications using bridge sensors.

### FEATURES

- Integrated features for interfacing multiple bridge sensors with an MCU or FPGA
  - 8:1 differential MUX with I<sup>2</sup>C interface
  - Instrumentation amplifier
  - LDO
  - Offset correction DAC with I<sup>2</sup>C interface ( $\pm 560\text{mV}$  offset correction range)
- Eight selectable voltage gains from 2V/V to 760V/V with only  $\pm 0.5\%$  gain error
- 3mV maximum input offset voltage
- 100pA maximum input bias current
- 559µA maximum supply current
- 2.7V to 5V analog supply voltage range
- 1.8V to 5V digital supply voltage range
- -40°C to 85°C temperature range
- 3.5mm x 3.5mm TQFN-24 package

### APPLICATIONS

- Bridge sensor interface
- Pressure and temperature sensors
- Strain gauge amplifier
- Industrial process controls
- Weigh scales

### Typical Application

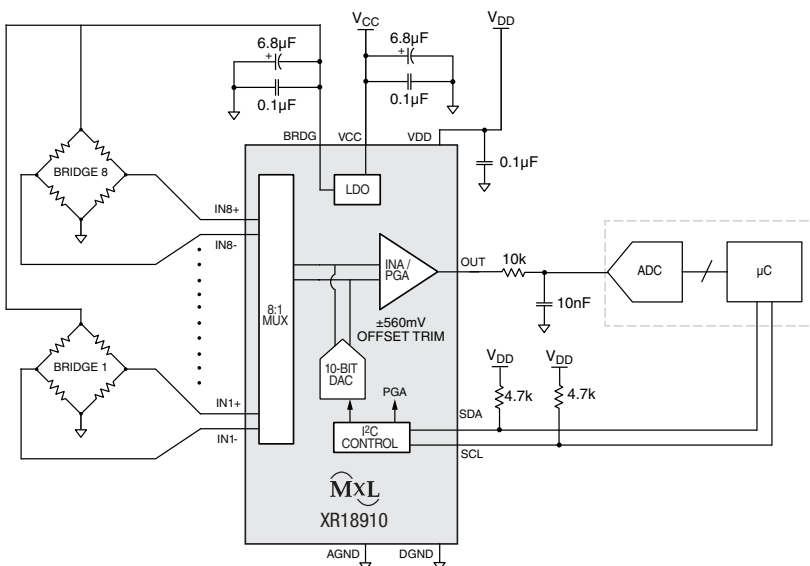

Figure 1. Typical Application

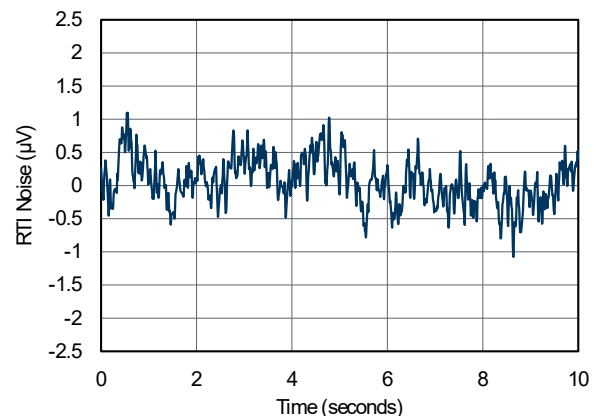

Figure 2. 0.1Hz to 10Hz RTI Voltage Noise

## Absolute Maximum Ratings

Stresses beyond the limits listed below may cause permanent damage to the device. Exposure to any Absolute Maximum Rating condition for extended periods may affect device reliability and lifetime.

Analog supply voltage ( $V_{CC}$ )	0V to 5.5V
Digital supply voltage ( $V_{DD}$ )	0V to 5.5V
Digital input/output ( $V_{DDIO}$ )	0V to 5.5V
$V_{IN}$	0 to $V_{CC}$
Differential input voltage (current limit of 10mA)	$V_{CC}$
ESD rating (HBM - human body model)	4kV

## Operating Conditions

Analog supply voltage range	2.7V to 5.25V
Digital supply voltage range	1.7V to 5.25V
Operating temperature range	-40°C to 85°C
Junction temperature	150°C
Storage temperature range	-65°C to 150°C
Lead temperature (soldering, 10s)	260°C
Package thermal resistance $\theta_{JA}$	50°C/W <sup>(1)</sup>

### NOTE:

1. JEDEC standard, multi-layer test boards, still air.

## Electrical Characteristics

$T_A = 25^\circ\text{C}$ ,  $V_{CC} = 3.3\text{V}$ ,  $V_{DD} = 1.8\text{V}$ ,  $R_L = 10\text{k}\Omega$  to  $1.5\text{V}$ ,  $G = 760$ , unless otherwise noted.

Symbol	Parameter	Conditions	Min	Typ	Max	Units
DC Performance						
$V_{IO}$	Input offset voltage	Input referred	-3	$\pm 0.02$	3	mV
$d_{VIO}$	Input offset voltage average drift			3		$\mu\text{V}/^\circ\text{C}$
$I_B$	Input bias current		-100	15	100	$\mu\text{A}$
$I_{OS}$	Input offset current		-100	1	100	$\mu\text{A}$
PSRR	Power supply rejection ratio	$V_{CC} = 2.7\text{V}$ to $5\text{V}$	60	91		dB
G	Gain = 2	Nominal, refer to Gain Register Table (pg. 8)		2.0		V/V
	Gain = 20			20.0		V/V
	Gain = 40			40.0		V/V
	Gain = 80			80.0		V/V
	Gain = 150			150.0		V/V
	Gain = 300			299.9		V/V
	Gain = 600			599.6		V/V
	Gain = 760			759.4		V/V
$G_E$	Gain error		-0.5		0.5	%
	Gain error vs temperature			$\pm 10$		$\text{ppm}/^\circ\text{C}$
$I_{SVCC}$	$V_{CC}$ supply current	No load to output, no load to LDO		435	530	$\mu\text{A}$
$I_{SVCCD}$	Disable $V_{CC}$ supply current	No load to output, no load to LDO		48	62	$\mu\text{A}$
$I_{SVDD}$	$V_{DD}$ supply current	No load to output, no load to LDO, $I^2\text{C}$ running		22	29	$\mu\text{A}$
$I_{STOTAL}$	Total supply current	No load to output, no load to LDO		457	559	$\mu\text{A}$
$I_{SDTOTAL}$	Total disable supply current	No load to output, no load to LDO, LDO DIS		45		$\mu\text{A}$
		No load to output, no load to LDO, LDO EN		70	91	$\mu\text{A}$
Input Characteristics						
	Input impedance			$10^{13} \parallel 11.2$		$\Omega \parallel \text{pF}$
CMIR	Common mode input range		0.5	0.23 to 3.06	2.5	V
CMRR	Common mode rejection ratio	Input referred, $V_{CM} = 0.5$ to $2.0\text{V}$	75	88		dB
Output Characteristics						
$V_{OUT}$	Output voltage swing	$R_L = 10\text{k}\Omega$ to $1.5\text{V}$	0.1	0.04 to 3.29	3.1	V
$V_{OO}$	Output offset	Offset DAC 0 00 0000 0000, $G = 2$	1.4	1.5	1.6	V
Offset DAC						
	Offset DAC range	RTI (referred to input)	$\pm 560$			mV
	Offset monotonicity		8	10		Bits
LDO						
	Output voltage	1.5k load, LDO bit LOW	-6%	3	+6%	V
		1.5k load, LDO bit HIGH	-6%	2.65	+6%	V
	Dropout voltage	$V_{CC} = 2.8\text{V}$ , LDO = $2.65\text{V}$ , $I_{LOAD} = 10\text{mA}$			150	mV
	Output current		10	25		mA
	Power supply rejection ratio	Output referred, $V_{CC} = 3\text{V}$ to $5\text{V}$ , LDO = $2.65\text{V}$	45	63		dB
		Output referred, $V_{CC} = 3.3\text{V}$ to $5\text{V}$ , LDO = $3\text{V}$	45	63		dB
	Output current sense transimpedance slope	Output voltage relative to $1.5\text{V}$ / LDO current, $G = 2$	0.08	0.1	0.12	V/mA
	Output current sense range clip	$G = 2$		18.8		mA

**Electrical Characteristics (Continued)**

$T_A = 25^\circ\text{C}$ ,  $V_{CC} = 3.3\text{V}$ ,  $V_{DD} = 1.8\text{V}$ ,  $R_L = 10\text{k}\Omega$  to  $1.5\text{V}$ ,  $G = 760$ , unless otherwise noted.

Symbol	Parameter	Conditions	Min	Typ	Max	Units
Dynamic Performance						
BW	-3dB bandwidth	$G = 760$		66		kHz
		$G = 2$		1300		kHz
SR	Slew rate	$V_{OUT} = 1V_{P-P}$ , $G = 2$		1		V/ $\mu\text{s}$
$e_{NI}$	Input voltage noise, RTI	$f = 10\text{Hz}$		75		nV/ $\sqrt{\text{Hz}}$
		$f = 100\text{Hz}$		46		nV/ $\sqrt{\text{Hz}}$
		$f = 1\text{kHz}$		35		nV/ $\sqrt{\text{Hz}}$
$i_N$	Input current noise	$f = 10\text{Hz}$		0.6		fA/ $\sqrt{\text{Hz}}$
$e_{NP-P}$	Peak-to-peak noise	$f = 0.1$ to $10\text{Hz}$		2		$\mu\text{V}_{P-P}$
XTALK	Crosstalk	Channel-to-channel, $f = 1\text{kHz}$		90		dB
$T_S$	Set-up time, 1% settling	Analog ready after serial register finished write		3.5		$\mu\text{s}$
$T_{WAKE}$	Wake up time, 1% settling	Wake from ACK of SLEEP_OUT command		9.6		$\mu\text{s}$

**Digital Characteristics (CMOS)**

Symbol	Parameter	Conditions	Min	Typ	Max	Units
$V_{IH}$	Logic input HIGH		$0.7 \times V_{DD}$		$V_{DD}$	V
$V_{IL}$	Logic input LOW		0		$0.3 \times V_{DD}$	V
$I_{IH}$	Input leakage HIGH	$V_I = V_S$			10	$\mu\text{A}$
$I_{IL}$	Input leakage LOW	$V_I = 0$	-10			$\mu\text{A}$
$CLK_F$	Clock rate				0.4	MHz

**I<sup>2</sup>C Bus Timing**

$T_A = -40$  to  $85^\circ\text{C}$ ,  $V_{DD} = 1.8$  to  $5\text{V}$ , unless otherwise noted.

Symbol	Parameter	Standard Mode I <sup>2</sup> C-BUS		Fast Mode I <sup>2</sup> C-BUS		Units
		Min	Max	Min	Max	
$f_{SCL}$	Operating frequency	0	100	0	400	kHz
$T_{BUF}$	Bus free time between STOP and START	4.7		1.3		$\mu\text{s}$
$T_{HD;STA}$	START condition hold time	4.0		0.6		$\mu\text{s}$
$T_{SU;STA}$	START condition setup time	4.7		0.6		$\mu\text{s}$
$T_{HD;DAT}$	Data hold time	0		0		$\mu\text{s}$
$T_{VD;ACK}$	Data valid acknowledge		0.6		0.6	$\mu\text{s}$
$T_{VD;DAT}$	SCL LOW to data out valid		0.6		0.6	ns
$T_{SU;DAT}$	Data setup time	250		150		ns
$T_{LOW}$	Clock LOW period	4.7		1.3		$\mu\text{s}$
$T_{HIGH}$	Clock HIGH period	4.0		0.6		$\mu\text{s}$
$T_F$	Clock/data fall time		300		300	ns
$T_R$	Clock/data rise time		1000		300	ns
$T_{SP}$	Pulse width of spikes tolerance	0.5		0.5		$\mu\text{s}$

Electrical Characteristics (Continued)

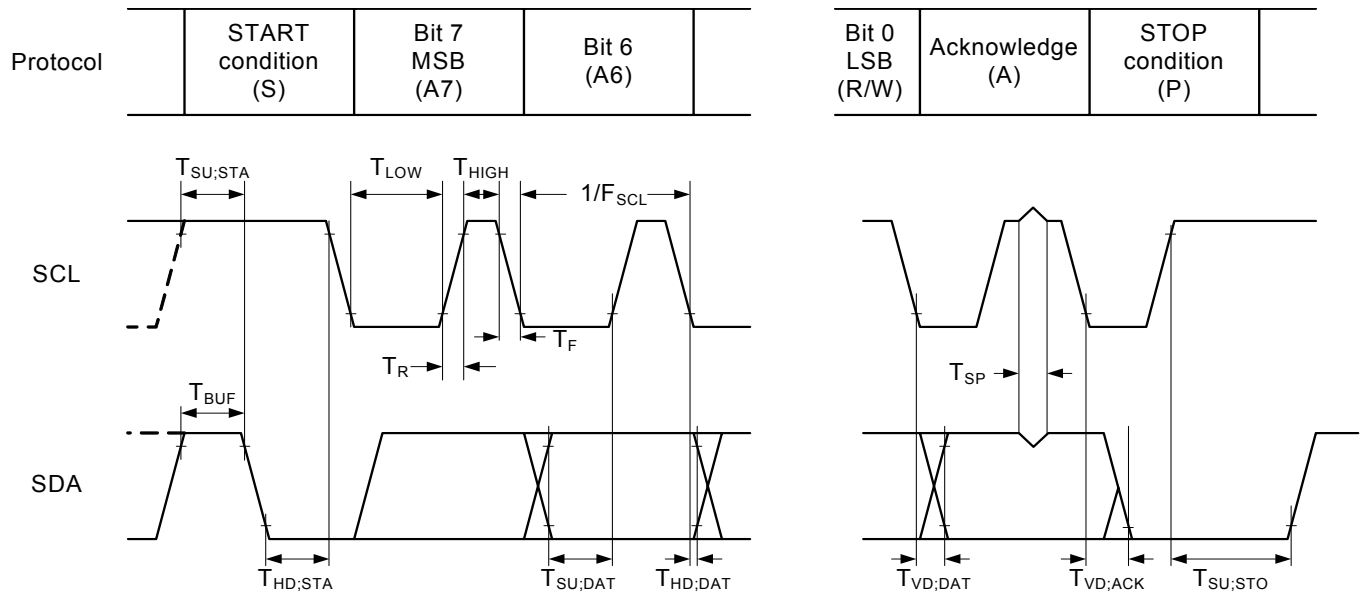

Figure 3. I<sup>2</sup>C Bus Timing Diagram

## Electrical Characteristics (Continued)

Table 1. Register List

Reg No.		Name	Function	R/ W/ C	Byte of Parameter	Parameter	Default Code	Power-up Condition	Remark
Hex	Dec								
0x00	0	NOP	No operation	C	0		N/A		Does not execute a function. NOP is used to test successful I <sup>2</sup> C communication
Reset									
0x01	1	SW_RESET	Software reset	C	0		N/A		Resets all registers to default values
Read ID									
0x02	2	DEVICE_ID	Read Device ID	R	2	[15:0]: report "8910" in BCD	0x8910		Instructs the XR18910 to report its device ID 8910 in binary form (1000 1001 0001 0000)
0x03	3	VERSION_ID	Read HW & SW version numbers	R	2	[15:12]: reserved [11:8]: Hardware version # [7:0]: Software version #	N/A		Initial H/W version number is '0'; Initial S/W version number is '01'.
Sleep in/out									
0x04	4	SLEEP_OUT_REG	Normal operating mode, system active	C	0		N/A	Active	Puts the XR18910 into active mode. (wake up)
0x05	5	SLEEP_IN_REG	Sleep Mode	C	0		N/A	Active	Puts the analog portion of the XR18910 into sleep mode. During sleep mode, the only I <sup>2</sup> C command that can be received/ processed is the SLEEP_OUT command (0x04). All other register addresses will be ignored.
Basic Config									
0x06	6	Gain	Gain select	R/W	1	[2:0]: Gain select	0x00	Gain = 2	Eight gain settings are selectable (from 2V/V to 760V/V), refer to the Gain Register Table for more information.
0x07	7	LDO	LDO Settings	R/W	1	[0]:LDO 3V, 2.65V [1]:LDO disable	0x00	LDO = 3V	Bit 0 controls the LDO voltage (0: 3V; 1: 2.65V). Bit 1 (Sleep Mode only). Bit 1 controls whether the LDO shuts down or stays on during Sleep Mode. (0: Enable; 1: Disable). When the XR18910 is active, the LDO is always on.
0x08	8	LDO Current Sense Select	LDO Current Sense	C	0		N/A	Off	When on, the LDO current is sensed and a proportional voltage is present at the output of the XR18910. Current Sense Mode remains active until an input select command is received by the XR18910.
Channel Switch (Input MUX Select)									
0x10	16	Select_Input_1	Select Channel 1	C	0		N/A	Channel 1 is selected	Select +IN1, -IN1; Channel 1
0x12	18	Select_Input_2	Select Channel 2	C	0				Select +IN2, -IN2; Channel 2
0x14	20	Select_Input_3	Select Channel 3	C	0				Select +IN3, -IN3; Channel 3
0x15	21	Select_Input_4	Select Channel 4	C	0				Select +IN4, -IN4; Channel 4
0x18	24	Select_Input_5	Select Channel 5	C	0				Select +IN5, -IN5; Channel 5
0x1A	26	Select_Input_6	Select Channel 6	C	0				Select +IN6, -IN6; Channel 6
0x1C	28	Select_Input_7	Select Channel 7	C	0				Select +IN7, -IN7; Channel 7
0x1E	30	Select_Input_8	Select Channel 8	C	0				Select +IN8, -IN8; Channel 8

Reg No.		Name	Function	R/ W/ C	Byte of Parameter	Parameter	Default Code	Power-up Condition	Remark
Hex	Dec								
Offset DAC Config									
0x20	32	DAC1	Configures DAC offset applied to Channel 1	R/W	2	[10]: DAC Sign [9:0]: DAC Range	0x00	0mV offset	Bit 10 controls the sign of the DAC offset voltage. Bits 9 thru 0 control the value of the DAC offset voltage. [10]: DAC Sign 0 = positive; 1 = negative
0x22	34	DAC2	Configures DAC offset applied to Channel 2	R/W	2				
0x24	36	DAC3	Configures DAC offset applied to Channel 3	R/W	2				
0x25	37	DAC4	Configures DAC offset applied to Channel 4	R/W	2				
0x28	40	DAC5	Configures DAC offset applied to Channel 5	R/W	2				
0x2A	42	DAC6	Configures DAC offset applied to Channel 6	R/W	2				
0x2C	44	DAC7	Configures DAC offset applied to Channel 7	R/W	2				
0x2E	46	DAC8	Configures DAC offset applied to Channel 8	R/W	2				

**NOTE:**  
Register numbers not listed above have no function.

Table 2. DAC Registers

Hex	D10	D9	D8	D7	D6	D5	D4	D3	D2	D1	D0	Offset % of FS Input	Voltage RTI
0x3FF	0	1	1	1	1	1	1	1	1	1	1	50	560mV
0x000	0	0	0	0	0	0	0	0	0	0	0	0	0
0x7FF	1	1	1	1	1	1	1	1	1	1	1	-50	-560mV
0x400	1	0	0	0	0	0	0	0	0	0	0	0	0
DAC Sign	10-Bit DAC Range												

Table 3. Gain Registers

Hex	D2	D1	D0	Gain
0x00	0	0	0	2
0x01	0	0	1	20
0x02	0	1	0	40
0x03	0	1	1	80
0x04	1	0	0	150
0x05	1	0	1	300
0x06	1	1	0	600
0x07	1	1	1	760



## Pin Configuration

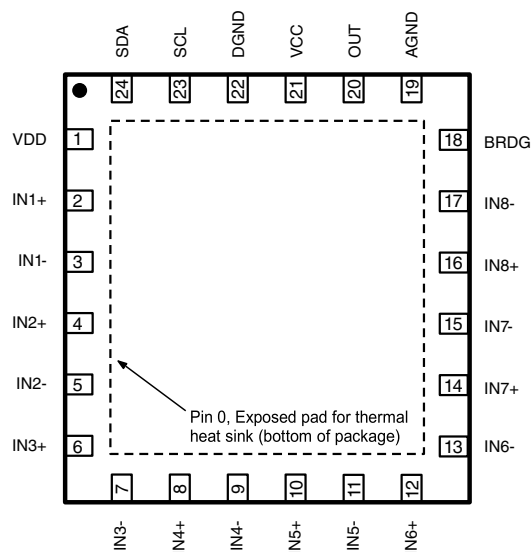

**NOTE:**  
MaxLinear recommends grounding the exposed pad.

## Pin Functions

Pin Number	Pin Name	Description
1	VDD	Digital Supply
2	IN1+	Positive Input 1
3	IN1-	Negative Input 1
4	IN2+	Positive Input 2
5	IN2-	Negative Input 2
6	IN3+	Positive Input 3
7	IN3-	Negative Input 3
8	IN4+	Positive Input 4
9	IN4-	Negative Input 4
10	IN5+	Positive Input 5
11	IN5-	Negative Input 5
12	IN6+	Positive Input 6
13	IN6-	Negative Input 6
14	IN7+	Positive Input 7
15	IN7-	Negative Input 7
16	IN8+	Positive Input 8
17	IN8-	Negative Input 8
18	BRDG	BRDG Power Connection (LDO output)
19	AGND	Analog Ground
20	OUT	Output
21	VCC	Analog Supply
22	DGND	Digital Ground
23	SCL	Serial Clock Input
24	SDA	Serial Data Input/Output

**Typical Performance Characteristics**

$T_A = 25^\circ\text{C}$ ,  $V_{CC} = 3.3\text{V}$ ,  $V_{DD} = 1.8\text{V}$ ,  $R_L = 10\text{k}\Omega$  to  $1.5\text{V}$ ,  $G = 760$ , unless otherwise noted.

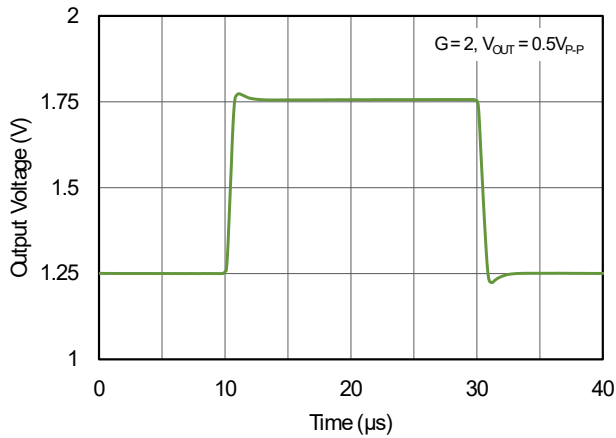

Figure 4. Small Signal Pulse Response at G = 2

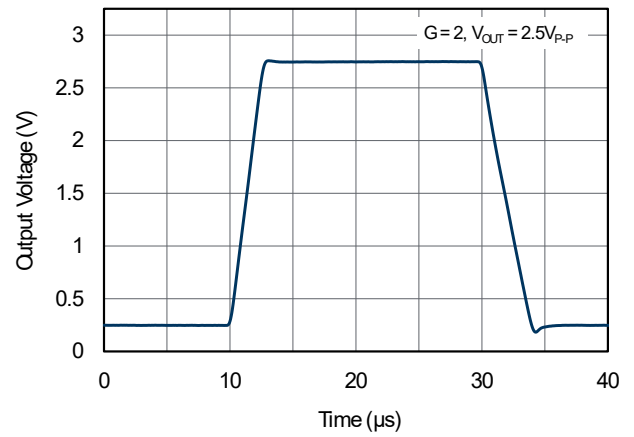

Figure 5. Large Signal Pulse Response at G = 2

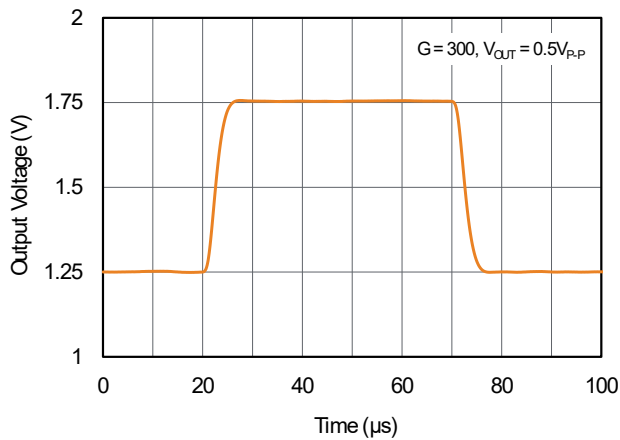

Figure 6. Small Signal Pulse Response at G = 300

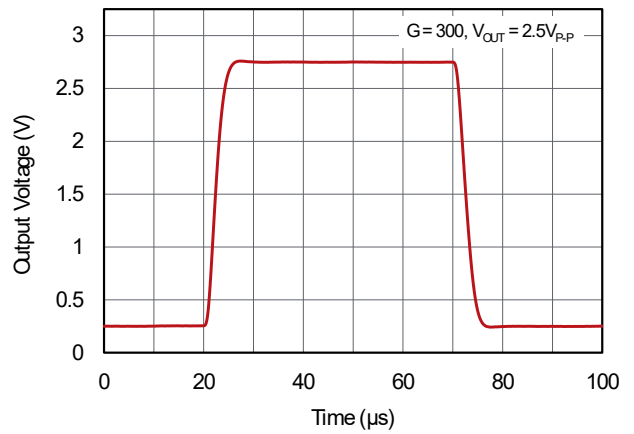

Figure 7. Large Signal Pulse Response at G = 300

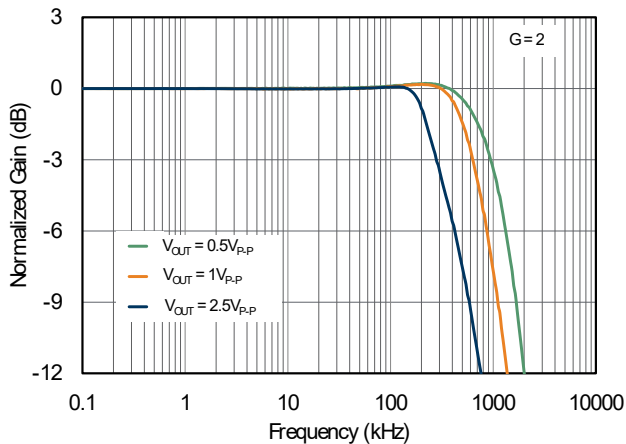

Figure 8. Frequency Response at G = 2

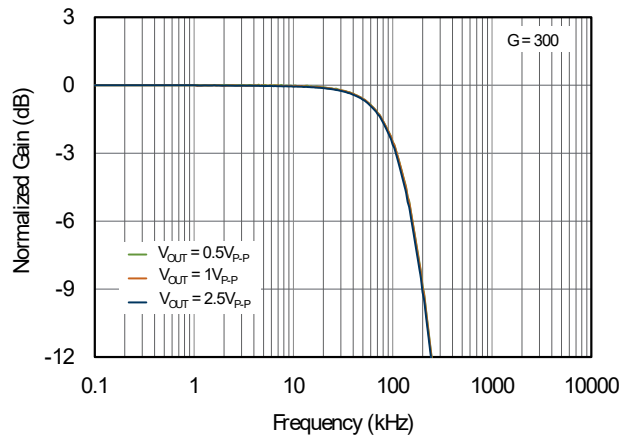

Figure 9. Frequency Response at G = 300

**Typical Performance Characteristics (Continued)**

$T_A = 25^\circ\text{C}$ ,  $V_{CC} = 3.3\text{V}$ ,  $V_{DD} = 1.8\text{V}$ ,  $R_L = 10\text{k}\Omega$  to  $1.5\text{V}$ ,  $G = 760$ , unless otherwise noted.

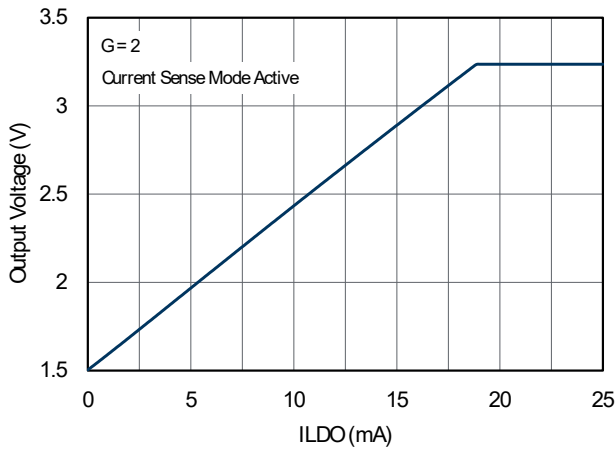

Figure 10. LDO Current vs. Output Voltage

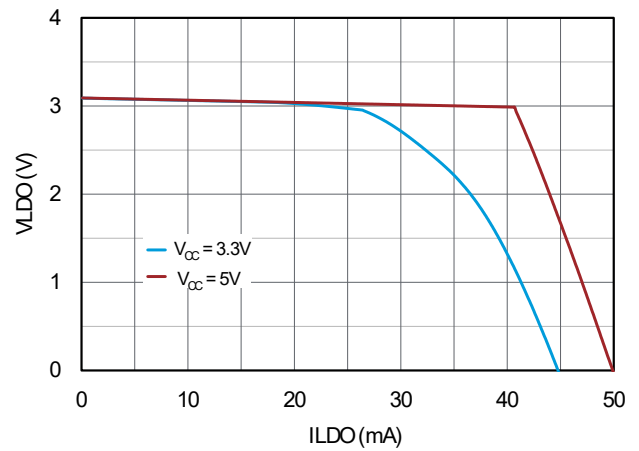

Figure 11. LDO Output Current

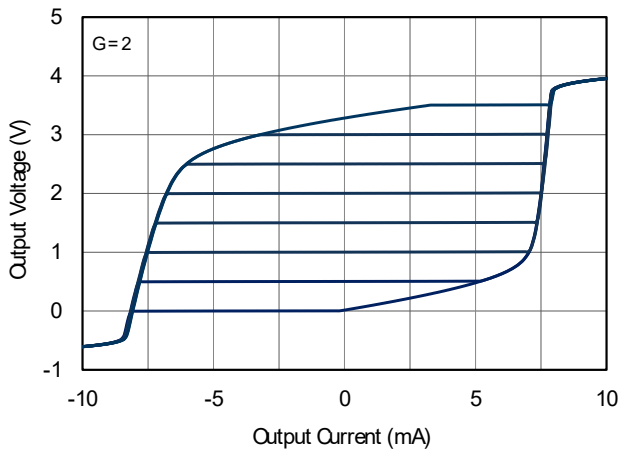

Figure 12. Output Offset Voltage vs. Output Current

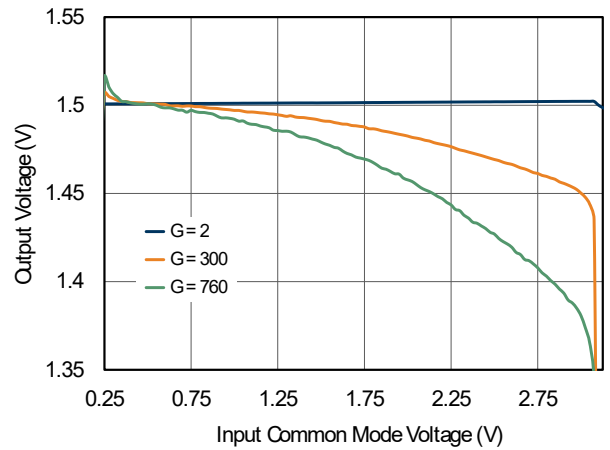

Figure 13. Output Offset vs. Input Common Mode Voltage

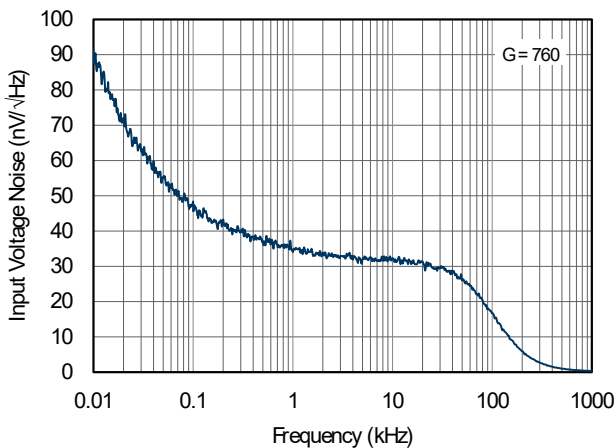

Figure 14. Input Voltage Noise vs. Frequency

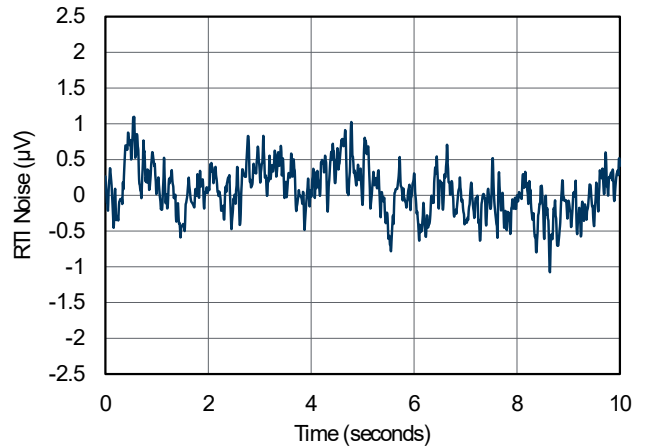

Figure 15. 0.1Hz to 10Hz RTI Voltage Noise

**Typical Performance Characteristics (Continued)**

$T_A = 25^\circ\text{C}$ ,  $V_{CC} = 3.3\text{V}$ ,  $V_{DD} = 1.8\text{V}$ ,  $R_L = 10\text{k}\Omega$  to  $1.5\text{V}$ ,  $G = 760$ , unless otherwise noted.

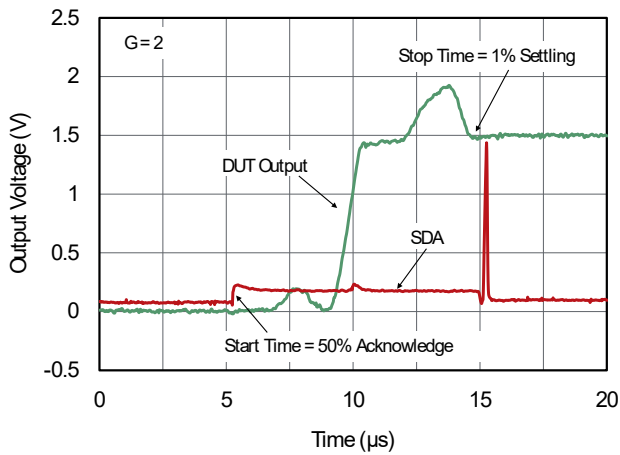

Figure 16. Sleep to Wake Time (DUT Output)

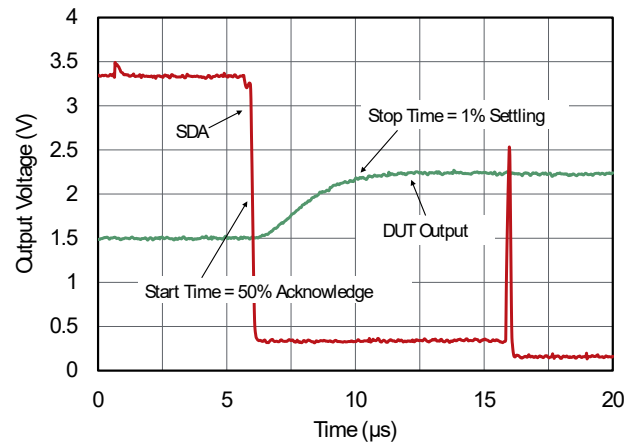

Figure 17. Set-up Time - from  $G = 2$  to  $G = 300$  (DUT Output)

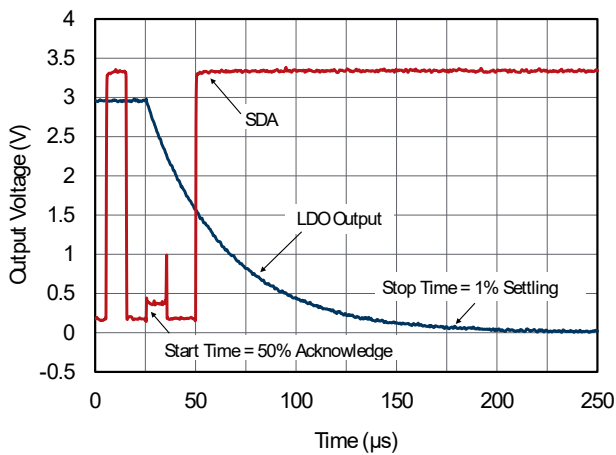

Figure 18. LDO Enable to Disable Time

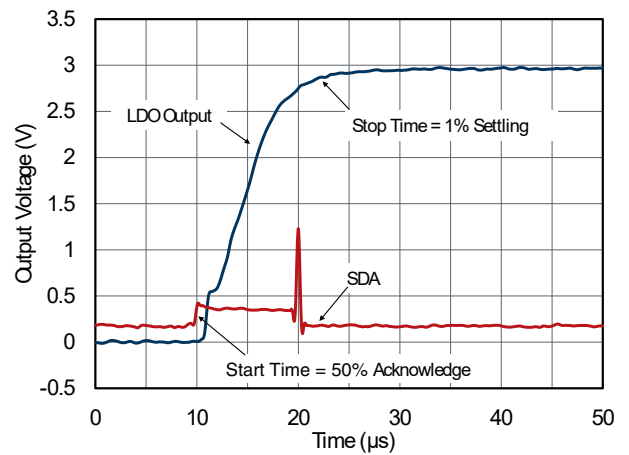

Figure 19. LDO Disable to Enable Time

## Functional Block Diagram

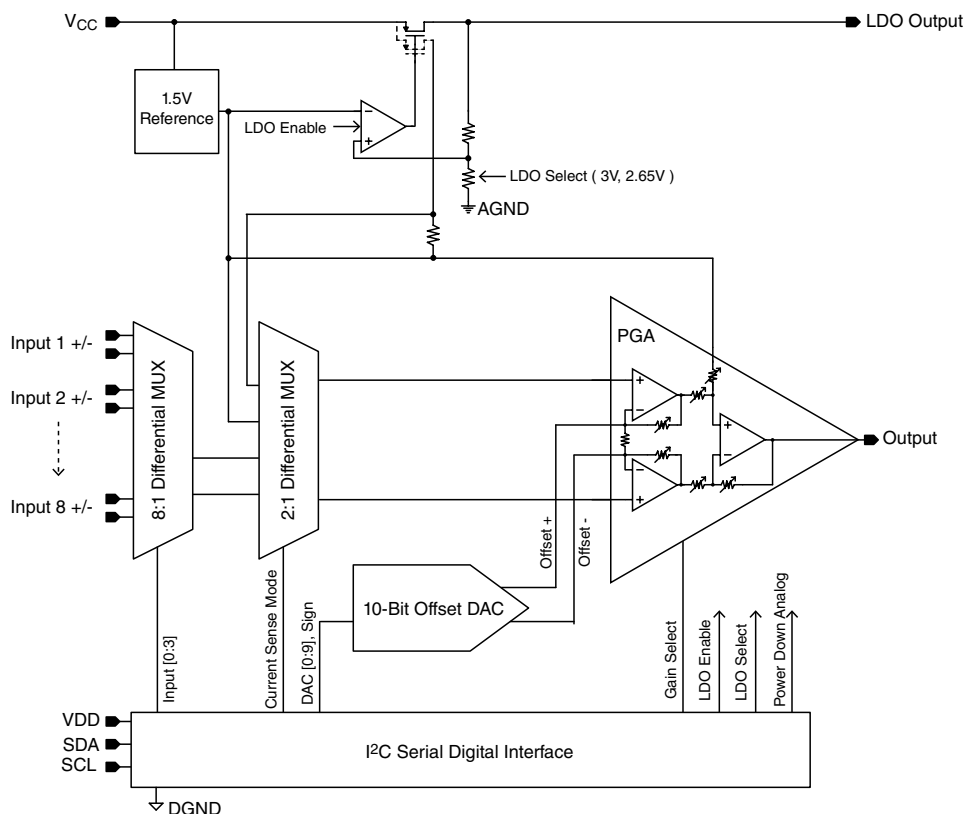

Figure 20. Functional Block Diagram

## Application Information

The XR18910 sensor interface includes a 8:1 differential multiplexer (MUX), a programmable gain instrumentation amplifier, a 10-bit offset correction DAC and an LDO. An I<sup>2</sup>C interface controls the many functions and features of the XR18910. The XR18910 is designed to integrate multiple bridge sensors with an ADC/MCU or FPGA.

Each bridge sensor connected to the XR18910 has its own inherent offset that if not calibrated out can decrease sensitivity and overall performance of the sensor system. The on-board DAC introduces an offset into the instrumentation amplifier to calibrate the offset voltage generated by the sensors. An independent offset can be set for each of the 8 channels. Only the offset voltage of the active channel is applied to the PGA.

The programmable gain instrumentation amplifier offers 8 selectable gains from 2V/V to 760V/V to amplify the signal such that it falls within the input range of the ADC.

An integrated LDO provides a regulated voltage to power the input bridge sensors and is selectable, between 3V and 2.65V. The LDO can be set to turn off when the XR18910 is in sleep mode to save power.

The XR18910 also provides the ability to monitor the LDO current. When the XR18910 is in current sense mode, an internal 2:1 MUX allows a voltage proportional to the LDO current to be present at the output. Once all channels have been calibrated, the LDO current can be used to indirectly monitor any voltage or resistive changes seen by the inputs.

The XR18910 also includes an internal 1.5V reference that is used by the internal LDO circuitry and used to set the reference voltage for the programmable gain instrumentation amplifier.

During sleep mode, the analog components of the XR18910 are powered down for added power savings.

The XR18910 offers many functions, each controlled by the I<sup>2</sup>C compatible serial interface:

- Input Selection
- Gain Selection
- Offset Correction
- LDO Enable/Select
- Current Sense Mode
- Sleep Mode (analog power down)

## Application Information (Continued)

### Power Up

After initial system power up, the I<sup>2</sup>C master must provide one SCL clock pulse prior to the first I<sup>2</sup>C access (first start condition). The first access to the XR18910 must be a RESET command.

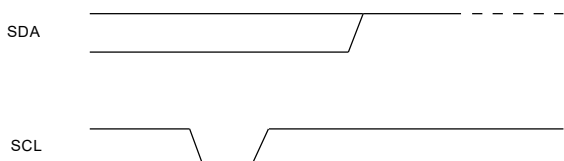

Figure 21. I<sup>2</sup>C Power Up

### I<sup>2</sup>C Bus Interface

The I<sup>2</sup>C-bus interface consists of two lines: serial data (SDA) and serial clock (SCL). The XR18910 works as a slave and supports both standard mode transfer rates (100 kbps) and fast mode transfer rates (400 kbps) as defined in the I<sup>2</sup>C-Bus specification. The I<sup>2</sup>C-bus interface follows all standard I<sup>2</sup>C protocols. Some information is provided below, for additional information, refer to the I<sup>2</sup>C-bus specifications.

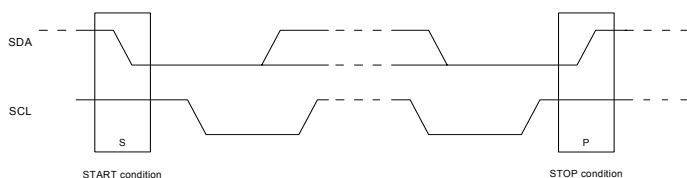

Figure 22. I<sup>2</sup>C Start and Stop Conditions

The basic I<sup>2</sup>C access cycle for the XR18910 consists of:

- A start condition
- A slave address cycle
- Zero, one, or two data cycles - depending on the XR18910 register accessed
- A stop condition

#### Start Condition

The master initiates data transfer by generating a start condition. The start condition is when a high-to-low transition occurs on the SDA line while SCL is high, as shown in Figure 22.

#### Slave Address Cycle

After the start condition, the first byte sent by the master is the 7-bit address and the read/write direction bit R/W on the SDA line. If the address matches the XR18910's internal fixed address, the XR18910 will respond with an acknowledge by pulling the SDA line low for one clock cycle while SCL is high.

#### Data Cycle

After the master detects this acknowledge, the next byte transmitted by the master is the sub-address. This 8-bit

sub-address contains the address of the register to access. The XR18910 Register List is shown in Table 1. Depending on the register accessed, there will be up to two additional data bytes transmitted by the master. Refer to the "Byte of Parameter" column in the Register Table. The XR18910 will respond to each write with an acknowledge.

#### Stop Condition

To signal the end of the data transfer, the master generates a stop condition by pulling the SDA line from low to high while the SCL line is high, as shown in Figure 22.

Figures 23 and 24 illustrate a write and a read cycle. For complete details, see the I<sup>2</sup>C-bus specifications.



#### NOTES:

White Block = host to XR18910, Orange Block = XR18910 to host.

Figure 23. Master Writes to Slave (XR18910)



#### NOTES:

White Block = host to XR18910, Orange Block = XR18910 to host.

Figure 24. Master Reads from Slave (XR18910)

### I<sup>2</sup>C Bus Addressing

The XR18910 uses a 7-bit I<sup>2</sup>C address. For the standard XR18910, the default address is 0x67 (110 0111). There are three alternative addresses available to help insure that the XR18910 can be identified from the other devices on the I<sup>2</sup>C-bus. Table 4 shows the different addresses that are available.

Table 4. XR18910 I<sup>2</sup>C Address Map

I <sup>2</sup> C Address	Orderable Part Number
0x67	XR18910ILTR-67
0x66	XR18910ILMTR-66
0x65	XR18910ILMTR-65
0x64	XR18910ILMTR-64

A read or write transaction is determined by the bit immediately following the I<sup>2</sup>C slave address. If this bit is '0', then it is a write transaction. If this bit is a '1', then it is a read transaction.

An I<sup>2</sup>C sub-address is sent by the I<sup>2</sup>C master following the slave address. The sub-address contains the XR18910 register address being accessed. Table 1 illustrates the available XR18910 register addresses.

After the last read or write transaction, the I<sup>2</sup>C-bus master will set the SCL signal back to its idle state (HIGH).

## Application Information (Continued)

### Inputs and Input Selection

The XR18910 includes 8 differential inputs and a 8:1 differential MUX that is controlled by an I<sup>2</sup>C compatible 2 wire serial interface. The XR18910 is designed to accept 8 differential inputs.

- If fewer than 4 differential inputs are required, tie the unused inputs to GND.
- If single ended inputs are required, tie the unused inputs to 1.5V.

The input common mode range of the XR18910 is typically 0.6V to 2.4V when running from a 3.3V supply. The XR18910 offers a very wide gain range. In most cases, the output voltage swing will be the limiting factor.

When the XR18910 is powered-up, the default input selected is Channel 1.

Inputs are selected via I<sup>2</sup>C using one of 8 register addresses 0x10, 0x12, 0x14, 0x15, 0x18, 0x1A, 0x1C, or 0x1E. Refer to the Register List in Table 1.

Example: The example below illustrates how to select Channel 4.

Step 1	0
Master sends start condition	S

Step 2	7	6	5	4	3	2	1	0
Master sends XR18910 address with write bit	1	1	0	0	1	1	1	0
7-bit XR18910 Address = 0x67								W

Step 3	9
XR18910 sends acknowledge	A

Step 4	7	6	5	4	3	2	1	0
Master sends address of register to access	0	0	0	1	0	1	0	1
Select Input 4 register address = 0x15								

Step 5	9
XR18910 sends acknowledge	A

Step 6	0
Master sends stop condition	P

#### NOTES:

White Block = host to XR18910, Orange Block = XR18910 to host, Grey Block = Notes.

### Gain Selection

The XR18910 offers 8 selectable fixed gains ranging from 2V/V to 760V/V. When the XR18910 is powered-up, the default gain is 2V/V.

The gain is selected via I<sup>2</sup>C using the register address 0x06 followed by another byte of data to select the gain. Refer to the Register List in Table 1 and the Gain Register list in Table 3.

Example: The example below illustrates how to select a gain of 150V/V.

To start communication with the XR18910, repeat steps 1-3 as shown in the Inputs and Input Selection section on page 14.

Step 4	7	6	5	4	3	2	1	0
Master sends address of register to access	0	0	0	0	0	1	1	0
Gain Select register address = 0x06								

Step 5	9
XR18910 sends acknowledge	A

Since the Gain Select register was accessed, the XR18910 is expecting another byte of data from the master to complete the command. Refer to the "Byte of Parameter" column in the Register List (Table 1). D0 thru D2 are used to select the gain. Refer to the Gain Register list in Table 3, 150V/V is D2 = 1, D1 = 0, and D0 = 0. This translates to a hex code of 0x04, since a full byte of data (8-bits) will be sent.

Step 6	7	6	5	4	3	2	1	0
Master sends gain register data to select G=150	0	0	0	0	0	1	0	0
Gain of 150V/V = 0x04								

Step 7	9
XR18910 sends acknowledge	A

Step 8	0
Master sends stop condition	P

#### NOTES:

White Block = host to XR18910, Orange Block = XR18910 to host, Grey Block = Notes.

## Application Information (Continued)

### Offset Correction

The XR18910 has a 10-bit offset correction DAC that can be used to provide digital calibration on each of the 8 inputs. Only the offset voltage of the active channel is applied to the PGA.

The DAC offset of each channel is controlled by the I<sup>2</sup>C compatible interface. At any time, the master can read or write to any of the DAC offset registers. The DAC offset for each channel is set via I<sup>2</sup>C using the register addresses 0x20 thru 0x2F followed by another two bytes of data to set the polarity and value of the offset voltage. Refer to the Register List in Table 1.

A ±560mV offset correction range is available. The full range of the DAC offset is only available at a gain of 2. At higher gains, the output voltage range of the XR18910 will be exceeded if the full range of the DAC offset is used. The internal 10-bit DAC allows 1,024 different offset voltage settings between 0mV and 560mV. The polarity of the offset correction is set with an additional bit. The unit offset is determined by the following:

$$\text{Unit Offset} = \frac{\text{Total Offset}}{\text{DAC Output Levels}} = \frac{560\text{mV}}{1024} = 547\mu\text{V}$$

From Table 3:

- 0x00 (hex) or 0 00 0000 0000 (binary) applies a 0mV offset
- 0x3FF (hex) or 0 11 1111 1111 (binary) applies a +560mV offset
- 0x7FF (hex) or 1 11 1111 1111 (binary) applies a -560mV offset

Each DAC output level provides an additional 547μV of offset. To determine what DAC output level corresponds to a specific desired offset, use the following equation:

$$x = \frac{\text{Desired Offset}}{\text{Unit Offset}}$$

See example below for additional information.

Example: The example below illustrates how to set the DAC offset for channel 4 to a value of 75mV.

To start communication with the XR18910, repeat steps 1-3 as shown in the Inputs and Input Selection section on page 14.

Step 4	7	6	5	4	3	2	1	0
Master sends address of register to access	0	0	1	0	0	1	0	1
<b>DAC4</b> register address = 0x25								

Step 5	9
XR18910 sends acknowledge	A

Since a DAC Offset register was accessed, the XR18910 is expecting another two bytes of data from the master to complete the command. Refer to the “Byte of Parameter” column in the Register List (Table 1). D0 thru D9 are used to set the offset voltage and D10 is used to set the sign of the offset voltage, 0 = positive and 1 = negative. Refer to the DAC Offset register list in Table 2.

To determine what DAC output level corresponds to 75mV, use the following equation:

$$\text{DAC Output Level} = \frac{\text{Desired Offset}}{\text{Unit Offset}} = \frac{75\text{mV}}{547\mu\text{V}} = 137$$

A decimal value of 137 corresponds to 75mV. Therefore:

- 0x89 (hex) or 0 00 1000 1001 (binary) applies a 75mV offset
- 0x489 (hex) or 1 00 1000 1001 (binary) applies a -75mV offset

Step 6	15	14	13	12	11	10	9	8
Master sends 1 <sup>st</sup> byte of DAC offset register data to select an offset of +75mV	0	0	0	0	0	0	0	0
							Sign	2 MSBs of 10-bit DAC output level that corresponds to 137 (0x89)

Step 7	9
XR18910 sends acknowledge	A

Step 8	7	6	5	4	3	2	1	0
Master sends 2 <sup>nd</sup> byte of DAC offset register data to select an offset of +75mV	1	0	0	0	1	0	0	1
8 LSBs of 10-bit DAC output level that corresponds to 137 (0x89)								

Step 9	9
XR18910 sends acknowledge	A

Step 10	0
Master sends stop condition	P

#### NOTES:

White Block = host to XR18910, Orange Block = XR18910 to host, Grey Block = Notes.



## Application Information (Continued)

### LDO Enable / Select (Power to External Bridge Sensors)

The XR18910 includes an on-board LDO that provides a regulated voltage that can be used to power external input bridge sensors. Two voltage options are available, 3V and 2.65V. The LDO voltage is selected via the I<sup>2</sup>C compatible two-wire serial interface.

When the XR18910 is powered-up, the default LDO voltage is 3V.

When the XR18910 is active (not in sleep mode), the LDO is always on. If the LDO voltage is not used, the LDO output can be left floating. The LDO can either stay on or shut down while the XR18910 is in Sleep Mode.

- Set LDO to shut down while XR18910 is in Sleep Mode to save power
- Set LDO to stay on while XR18910 is in Sleep Mode to improve wake-up time

The LDO voltage and disable setting are selected via I<sup>2</sup>C using the register address 0x07 followed by another byte of data to select the voltage and disable setting. Refer to the Register List in Table 1 and the example below for more information.

Example: The example below illustrates how to select an LDO voltage of 2.65V and keep the LDO enabled during Sleep Mode.

To start communication with the XR18910, repeat steps 1-3 as shown in the Inputs and Input Selection section on page 14.

Step 4	7	6	5	4	3	2	1	0
Master sends address of register to access	0	0	0	0	0	1	1	1
<b>LDO Settings</b> register address = 0x07								

Step 5	9
XR18910 sends acknowledge	A

Since the LDO Settings register was accessed, the XR18910 is expecting another byte of data from the master to complete the command. Refer to the “Byte of Parameter” column in the Register List (Table 1). D0 and D1 are used to select the LDO voltage and enable/disable the LDO during Sleep Mode. Bit 0 (D0) controls the LDO voltage (0: 3V; 1: 2.65V). Bit 1 (D1) is only applicable in Sleep Mode. Bit 1 controls whether the LDO shuts down or stays on during sleep mode (0: Enable; 1: Disable). When the XR18910 is active, the LDO is always on.

Step 6	7	6	5	4	3	2	1	0	
Master sends code to select LDO voltage of 2.65V and Enable LDO during Sleep Mode	0	0	0	0	0	0	0	0	
								0 = Enable	1 = 2.65V

Step 7	9
XR18910 sends acknowledge	A

Step 8	0
Master sends stop condition	P

#### NOTES:

White Block = host to XR18910, Orange Block = XR18910 to host, Grey Block = Notes.

### Current Sense Mode (Monitoring the LDO Current)

Current Sense Mode is activated via I<sup>2</sup>C using the register address 0x08. When activated, the LDO current is sensed and a proportional voltage is present at the output of the XR18910 (ILDO = VOUT/RL). Current Sense Mode stays active until the XR18910 receives any input select command (0x10, 0x12, 0x14, 0x15, 0x18, 0x1A, 0x1C, or 0x1E).

Current sense mode can be used to monitor the change over time of the bridge impedance.

### Sleep Mode (Analog Power Down)

Sleep mode is activated via I<sup>2</sup>C using the register address 0x05. When activated, the XR18910 will enter sleep mode. During sleep mode, the analog portion of the XR18910 is disabled. All register settings are retained during sleep mode.

During sleep mode, the nominal supply current will drop below 70μA (with LDO on) and below 45μA (with LDO off).

During sleep mode, the master can read the value in any register that saves a value during sleep mode. The only I<sup>2</sup>C commands that can be received or processed are the SLEEP\_OUT (wake up) command (0x04) and the LDO on/off and voltage command (0x07). All other register addresses will be ignored.

Register address 0x04 is used to return to normal operation (exit Sleep Mode).

By default, the XR18910 is active.

## Application Information (Continued)

### Typical Application – 8:1 Bridge Sensor Interface

The XR18910 was designed to interface multiple bridge sensors with a microcontroller or FPGA as illustrated in Figure 25.

The bridge output signal is differential ( $V_{O+}$  and  $V_{O-}$ ). Ideally, the unloaded bridge output is zero ( $V_{O+}$  and  $V_{O-}$  are identical). However, in-exact resistive values result in a difference between  $V_{O+}$  and  $V_{O-}$ . This bridge offset voltage can be substantial and vary between sensors. The XR18910 provides the ability to calibrate the bridge offset on each of the 8 bridge sensors using the on-board DAC.

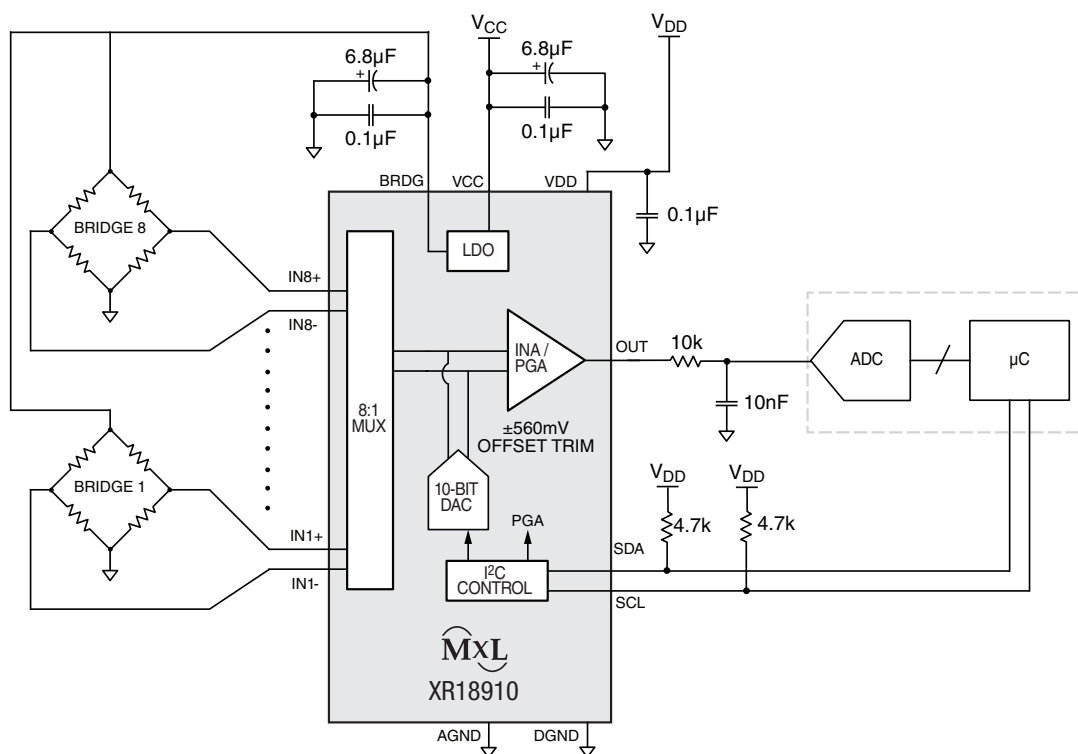

Figure 25. 8:1 Bridge Sensor Interface

### Layout Considerations

General layout and supply bypassing play major roles in high frequency performance. Follow the steps below as a basis for high frequency layout:

- Include 6.8µF and 0.1µF ceramic capacitors for power supply decoupling
- Place the 6.8µF capacitor within 0.75 inches of the power pin
- Place the 0.1µF capacitor within 0.1 inches of the power pin
- Connection to the exposed pad is not required. Exposed pad can be connected to ground (GND).
- Minimize all trace lengths to reduce series inductances

Mechanical Dimensions

TQFN24 3.5 x 3.5

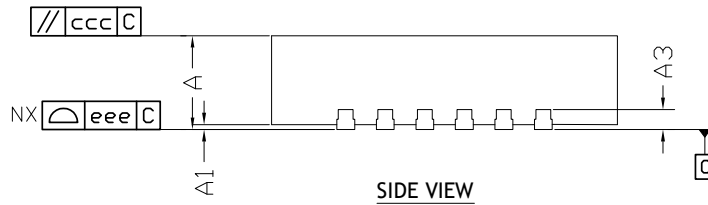
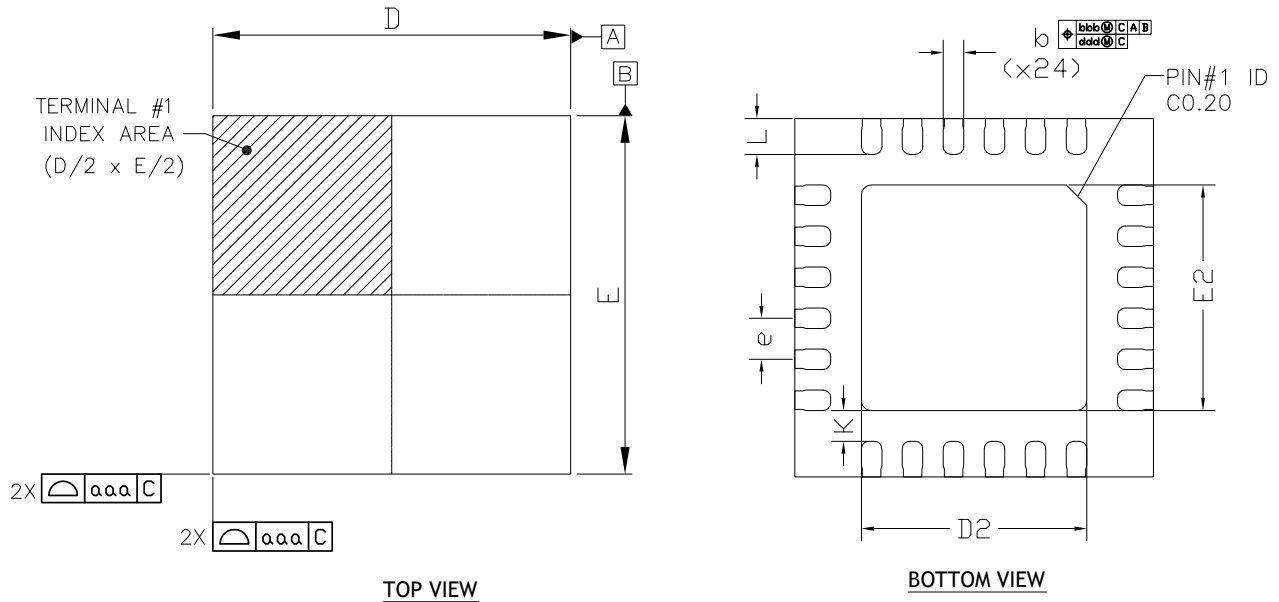

DIM SYMBOL	MIN	NOM	MAX
A	0.70	0.75	0.80
A1	0.00	0.02	0.05
A3	---	0.20Ref	---
b	0.15	0.20	0.25
D	3.50 BSC		
E	3.50 BSC		
e	0.40 BSC		
D2	2.15	2.20	2.25
E2	2.15	2.20	2.25
L	0.30	0.35	0.40
K	0.20	-	-
aaa		0.10	
bbb		0.10	
ccc		0.10	
ddd		0.05	
eee		0.08	
N		24	

TERMINAL DETAILS

- ALL DIMENSIONS ARE IN MILLIMETERS.
- DIMENSIONS AND TOLERANCE PER JEDEC MO-220.

Drawing No.: POD-00000070

Revision: B

Recommended Land Pattern and Stencil

TQFN24 3.5 x 3.5

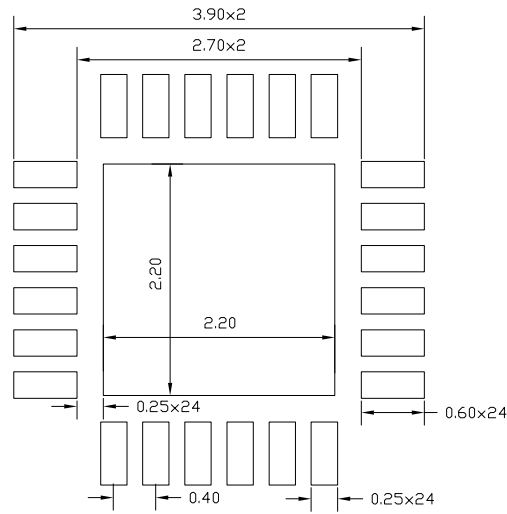

TYPICAL RECOMMENDED LAND PATTERN

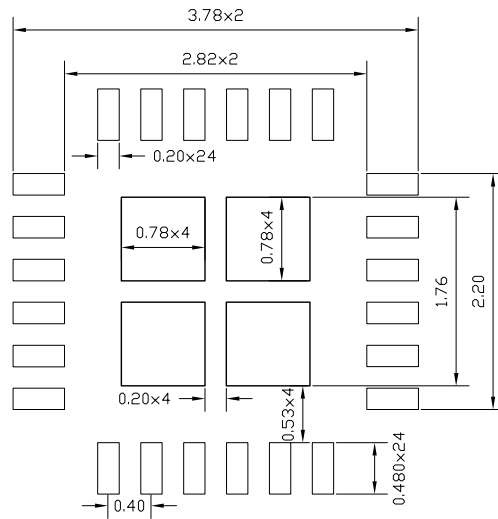

TYPICAL RECOMMENDED STENCIL

Drawing No.: POD-0000070

Revision: B

Ordering Information<sup>(1)</sup>

Part Number	Operating Temperature Range	Lead-Free	Package	Packaging Method
XR18910ILTR-67	-40°C to 85°C	Yes <sup>(2)</sup>	3.5mm x 3.5mm TQFN-24	Tape and Reel
XR18910ILMTR-67				Tape and Mini Reel
XR18910ILMTR-66				
XR18910ILMTR-65				
XR18910ILMTR-64				
XR18910ILEVB	Evaluation board			

## NOTES:

1. Refer to [www.exar.com/XR18910](http://www.exar.com/XR18910) for most up-to-date Ordering Information.
2. Visit [www.exar.com](http://www.exar.com) for additional information on Environmental Rating.

## Revision History

Revision	Date	Description
1A	March 2016	Initial Release
1B	May 2016	Added clarity to I <sup>2</sup> C Bus Addressing section. Updated Table 4. Updated Step 2 in Inputs and Input Selection section.
1C	March 2018	Updated to MaxLinear logo. Updated format and Ordering Information. Added I <sup>2</sup> C Power Up section. Package name updated to TQFN.



**Corporate Headquarters:**  
 5966 La Place Court  
 Suite 100  
 Carlsbad, CA 92008  
 Tel.: +1 (760) 692-0711  
 Fax: +1 (760) 444-8598  
[www.maxlinear.com](http://www.maxlinear.com)

**High Performance Analog:**  
 1060 Rincon Circle  
 San Jose, CA 95131  
 Tel.: +1 (669) 265-6100  
 Fax: +1 (669) 265-6101  
 Email: [hpatechsupport@exar.com](mailto:hpatechsupport@exar.com)  
[www.exar.com](http://www.exar.com)

The content of this document is furnished for informational use only, is subject to change without notice, and should not be construed as a commitment by MaxLinear, Inc.. MaxLinear, Inc. assumes no responsibility or liability for any errors or inaccuracies that may appear in the informational content contained in this guide. Complying with all applicable copyright laws is the responsibility of the user. Without limiting the rights under copyright, no part of this document may be reproduced into, stored in, or introduced into a retrieval system, or transmitted in any form or by any means (electronic, mechanical, photocopying, recording, or otherwise), or for any purpose, without the express written permission of MaxLinear, Inc.

MaxLinear, Inc. does not recommend the use of any of its products in life support applications where the failure or malfunction of the product can reasonably be expected to cause failure of the life support system or to significantly affect its safety or effectiveness. Products are not authorized for use in such applications unless MaxLinear, Inc. receives, in writing, assurances to its satisfaction that: (a) the risk of injury or damage has been minimized; (b) the user assumes all such risks; (c) potential liability of MaxLinear, Inc. is adequately protected under the circumstances.

MaxLinear, Inc. may have patents, patent applications, trademarks, copyrights, or other intellectual property rights covering subject matter in this document. Except as expressly provided in any written license agreement from MaxLinear, Inc., the furnishing of this document does not give you any license to these patents, trademarks, copyrights, or other intellectual property.

Company and product names may be registered trademarks or trademarks of the respective owners with which they are associated.

© 2016 - 2018 MaxLinear, Inc. All rights reserved