



Chipsmall Limited consists of a professional team with an average of over 10 year of expertise in the distribution of electronic components. Based in Hongkong, we have already established firm and mutual-benefit business relationships with customers from,Europe,America and south Asia,supplying obsolete and hard-to-find components to meet their specific needs.

With the principle of “Quality Parts,Customers Priority,Honest Operation,and Considerate Service”,our business mainly focus on the distribution of electronic components. Line cards we deal with include Microchip,ALPS,ROHM,Xilinx,Pulse,ON,Everlight and Freescale. Main products comprise IC,Modules,Potentiometer,IC Socket,Relay,Connector.Our parts cover such applications as commercial,industrial, and automotives areas.

We are looking forward to setting up business relationship with you and hope to provide you with the best service and solution. Let us make a better world for our industry!



## Contact us

Tel: +86-755-8981 8866 Fax: +86-755-8427 6832

Email & Skype: info@chipsmall.com Web: www.chipsmall.com

Address: A1208, Overseas Decoration Building, #122 Zhenhua RD., Futian, Shenzhen, China





# XR77129EVB-DEMO-1

## Universal PMIC 40V Quad Output Digital PWM/PFM Demo Board

December 2014

Rev. 1.0.0

### GENERAL DESCRIPTION

The XR77129EVB-DEMO-1 board is a complete four channel power system. It is configured to provide 5.0V, 12V, 3.3V and 2.5V at a maximum of 5A, 3A, 5A and 10A loads respectively. The 2.5V supply can be adjusted in 5mV increments. The 3.3V and 5V supplies are adjustable in 10mV increments. The 12V output is using external resistor divider. The order and ramp rates for each supply can be programmed to accommodate any sequencing requirement. All power supply operations can be controlled over an I<sup>2</sup>C interface. Faults, output voltages and currents can also be monitored. Two GPIO and three PSIO signals are available and can be programmed to provide a variety of functions. Unused GPIO/PSIO pins can be programmed as I/O expansion for a microcontroller. The board is supported by PowerArchitect™ 5.2 or later and plugs directly onto the interposer board acting as an interface to an Arduino controller or Exar's XCM.

### EVALUATION BOARD MANUAL

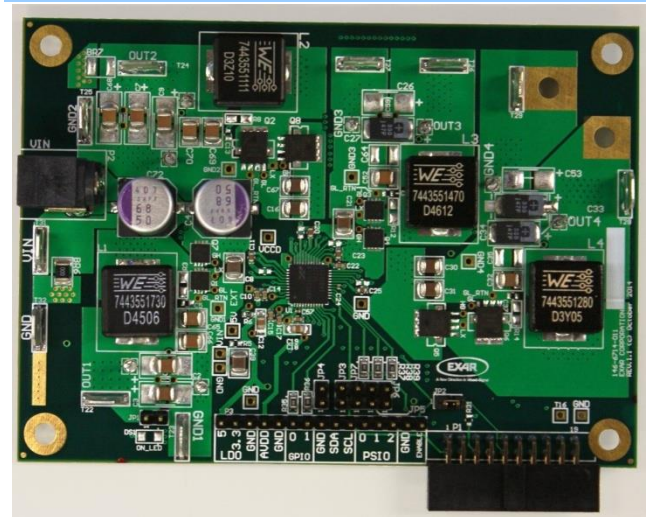

XR77129EVB-DEMO-1

### FEATURES

- **XR77129 Programmable Controller**
- **4 Channel Power System**
- **Wide Input Voltage Range: 6V-40V**
- **I<sup>2</sup>C Interface**
  - Programming
  - Remote re-configurability
  - Monitoring
  - Control
- **Arduino GPIO, PSIO and ENABLE control**





# XR77129EVB-DEMO-1

## Universal PMIC 40V Quad Output Digital PWM/PFM Demo Board

### PIN CONFIGURATION

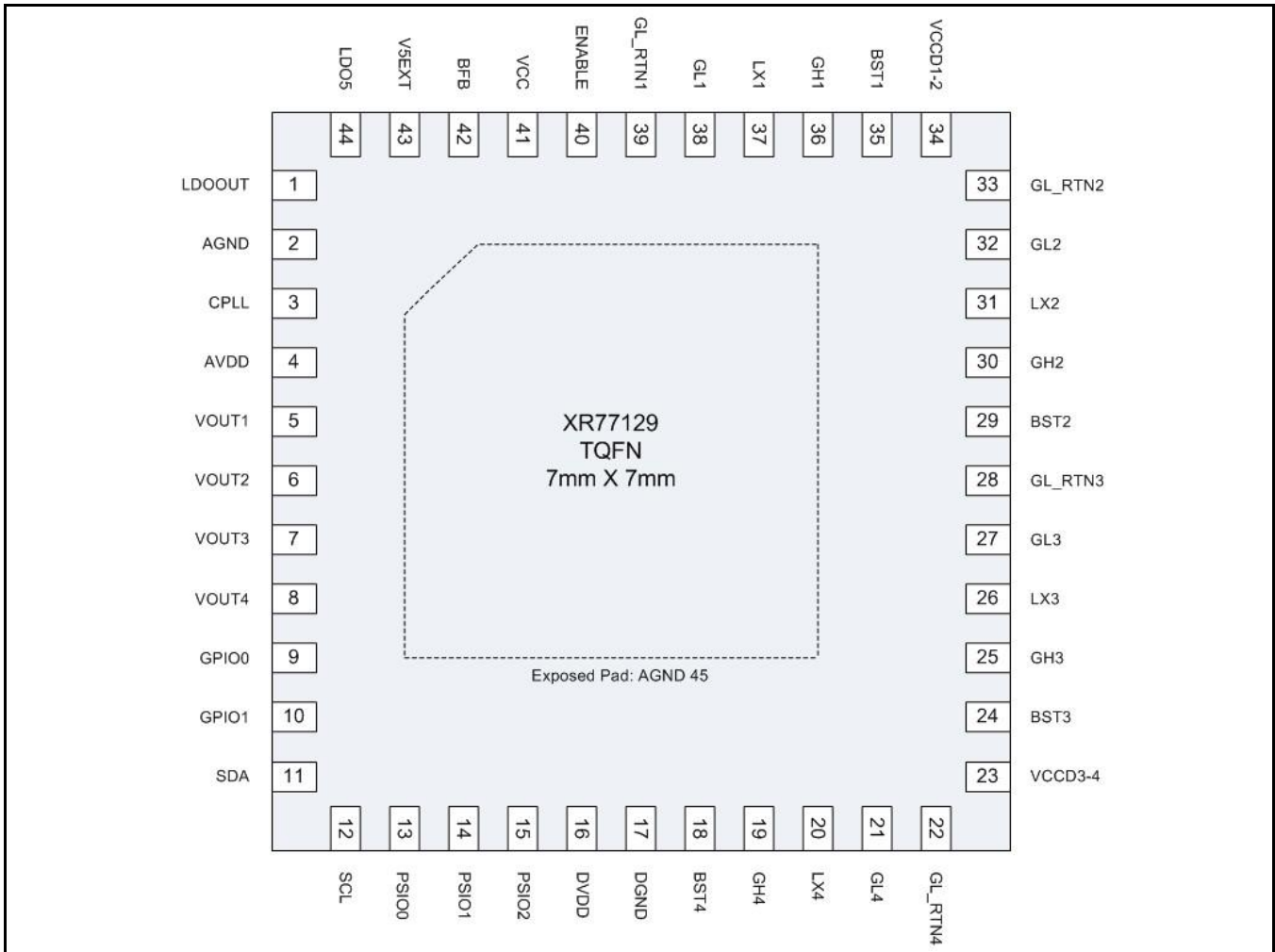

Figure 1 XR77129 Pin Assignment

### PIN ASSIGNMENTS

Pin Number	Pin Name	Description
1	LDOOUT	Output of the standby LDO. This is a micro power LDO that needs to be configured or commanded to turn on.
2	AGND	Analog ground pin. This is the small signal ground connection.
3	CPLL	Connect to a 2.2nF capacitor to GND.
4	AVDD	Output of the internal 1.8V LDO. A decoupling capacitor should be placed between AVDD and AGND close to the chip.
5, 6, 7, 8	VOUT1, VOUT2, VOUT3, VOUT4	Connect to the output of the corresponding power stage. The output is sampled at least once every switching cycle.
9, 10	GPI00, GPI01	These pins can be configured as inputs or outputs to implement custom flags, power good signals, enable/disable controls and synchronization to an external clock.
11, 12	SDA, SCL	SMBus/I2C serial interface communication pins.
13, 14, 15	PSIO0, PSIO1, PSIO2	Open drain, these pins can be used to control external power MOSFETs to switch loads on and off, shedding the load for fine grained power management. They can also be configured as standard logic outputs or inputs just as any of the GPIOs can be configured, but as open drains require an external pull-up when configured as outputs.
16	DVDD	1.8V supply input for digital circuitry. Connect pin to AVDD. Place a decoupling



# XR77129EVB-DEMO-1

## Universal PMIC 40V Quad Output Digital PWM/PFM Demo Board

Pin Number	Pin Name	Description
		capacitor close to the controller IC.
17	DGND	Digital ground pin. This is the logic ground connection, and should be connected to the ground plane close to the PAD.
18, 24, 29, 35	BST4, BST3, BST2, BST1	High side driver supply pin(s). Connect BST to the external capacitor as shown in the Typical Application Circuit. The high side driver is connected between the BST pin and LX pin and delivers the BST pin voltage to the high side FET gate each cycle.
19, 25, 30, 36	GH4, GH3, GH2, GH1	Output pin of the high side gate driver. Connect directly to the gate of an external N-channel MOSFET.
20, 26, 31, 37	LX4, LX3, LX2, LX1	Lower supply rail for the GH high-side gate driver. Connect this pin to the switching node at the junction between the two external power MOSFETs and the inductor. These pins are also used to measure voltage drop across bottom MOSFETs in order to provide output current information to the control engine.
21, 27, 32, 38	GL4, GL3, GL2, GL1	Output pin of the low side gate driver. Connect directly to the gate of an external N-channel MOSFET.
22, 28, 33, 39	GL_RTN4, GL_RTN3, GL_RTN2, GL_RTN1	Ground connection for the low side gate driver. This should be routed as a signal trace with GL. Connect to the source of the low side MOSFET.
23, 34	VCCD3-4, VCCD1-2	Gate Drive supply. Two independent gate drive supply pins where pin 34 supplies drivers 1 and 2 and pin 23 supplies drivers 3 and 4. One of the two pins must be connected to the LDO5 pin to enable two power rails initially. It is recommended that the other VCCD pin be connected to the output of a 5V switching rail (for improved efficiency or for driving larger external FETs), if available, otherwise this pin may also be connected to the LDO5 pin. A bypass capacitor (>1uF) to the system ground is recommended for each VCCD pin with the pin(s) connected to LDO5 with shortest possible length of etch.
40	ENABLE	If ENABLE is pulled high or allowed to float high, the chip is powered up (logic is reset, registers configuration loaded, etc.). The pin must be held low for the XR77129 to be placed into shutdown.
41	VCC	Input voltage. Place a decoupling capacitor close to the controller IC. This input is used in UVLO fault generation.
42	BFB	Input from the 15V output created by the external boost supply. When this pin goes below a pre-defined threshold, a pulse is created on the low side drive to charge this output back to the original level. If not used, this pin should be connected to GND.
43	V5EXT	External 5V that can be provided. If one of the output channels is configured for 5V, then this voltage can be fed back to this pin for reduced operating current of the chip and improved efficiency.
44	LDO5	Output of a 5V LDO. This LDO is used to power the internal Analog Blocks.
45	PAD	This is the die attach paddle, which is exposed on the bottom of the part. Connect externally to the ground plane.

### ORDERING INFORMATION

Part Number	Description
XR77129EVB-DEMO-1	Evaluation Board
XR77129EVB-DEMO-1-KITA	Evaluation kit includes XR77129EVB-DEMO-1 Evaluation Board with Power Architect software, interface and Arduino controller boards
XR77EVB-INT-1	Interface board (Arduino shield board) designed for use with an Arduino controller and compatible evaluation boards. Also has connectivity for the Exar Configuration Module (XCM)
XRP77XEVB-XCM	Exar Configuration Module (XCM). USB to I2C interface board.



# XR77129EVB-DEMO-1

## Universal PMIC 40V Quad Output Digital PWM/PFM Demo Board

### USING THE EVALUATION BOARD

#### INPUT VOLTAGE RANGE

The input voltage range of these boards is from 6V to 40V. The power components have been optimized for a 24V input rail. When running the board at an input voltage other than 24V, use PowerArchitect™ 5.2 to evaluate the system performance.

#### I<sup>2</sup>C INTERFACE

The XR77129 programmable power controller employs a standard I<sup>2</sup>C interface. Although the I<sup>2</sup>C signals can be pulled up to LDO5 on board by means of installing jumpers at the locations JP3 and JP4, the I<sup>2</sup>C bus signals are pulled up on the controller interface board (XR77EVB-INT-1) by default (refer to Appendix – jumpers installed shorting pins 2 and 3 together at the locations JP6 and JP7).

#### OPERATING THE EVALUATION BOARD

The XR77129EVB-DEMO-1 is designed to be powered from either an AC/DC wall wart (the output voltage must be in the range of the controllers - 6V to 40V) connected to the barrel connector or a test bench DC power supply (the voltage must be in the range of the controllers - 6V to 40V) connected to the V<sub>IN</sub> connectors.

#### BRING UP PROCEDURE

Plug the XR77129EVB-DEMO-1 evaluation board and the Arduino board into the controller interface board as shown below.



Load the [latest](#) PowerArchitect™ 5 software and run it.

After selecting the proper family (Chips) and the device (XR77129), select the “Get Started with the EVB-DEMO1” option when prompted as shown below.

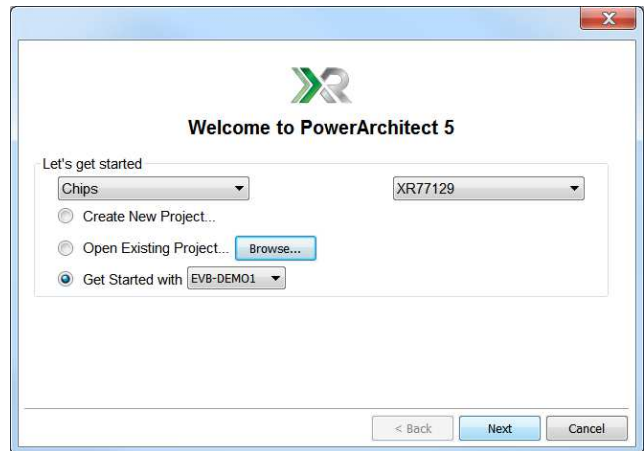

When done, click “Create”. PowerArchitect™ 5.2 will load the default configuration automatically.

Apply Power to the board. Please refer to the sections above on how to properly supply power to the board and what voltage range to use.

Turn on the Power supply.

Use USB cable to connect the computer (type A) and the Arduino controller board (type B).

Go to the Tools tab in PA 5.2 and select Boards. The software will identify communication ports where it found the Arduino controller board. Select the port.

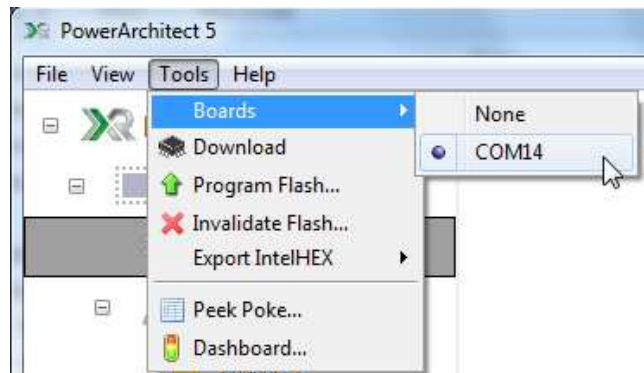



PA 5.2 is now communicating with the Arduino controller board which is indicated in the lower left corner.

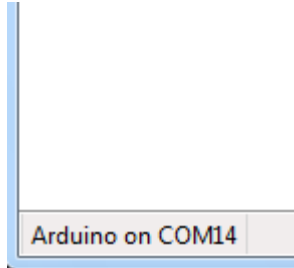

### Regulation

Note that XR77129EVB-DEMO-1 boards will be pre-loaded with the default configuration.

To enable channel regulation go to the Tools tab in PA 5.2 and select Dashboard.



In Dashboard turn Group 1 and Group 2 on. The configuration groups the channels 1, 2 and LDOOUT into the group 1, and the channels 3 and 4 into the group 2. The channels are now in regulation as indicated by VOUT readings as well as the in-regulation indicators.

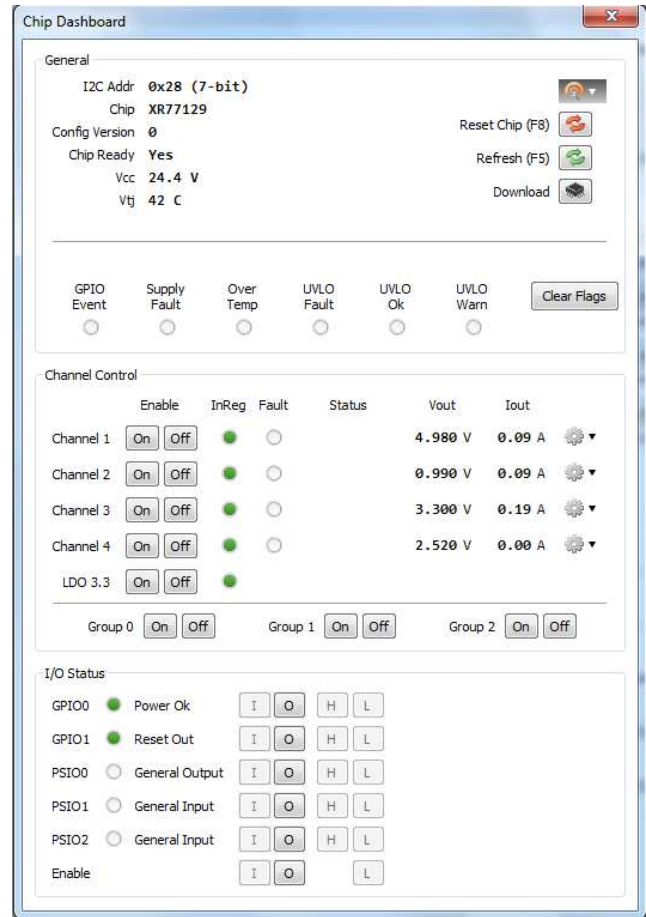

Channels can be turned on individually if desired.

### GPIO and PSIO interface

The GPIOs, PSIOs and ENABLE can be controlled from the Arduino controller dynamically in the dashboard.

ENABLE signal is connected to the Arduino controller board by default (JP2 header is shorted). Arduino drives the ENABLE pin low to place XR77129 into the shutdown mode. It releases the ENABLE pin to enable the device. If leaving the ENABLE pin floating is desired, the jumper at JP2 shall be removed.

The PSIOs are not pulled up on XR77129EVB-DEMO-1 by default. There is a loading option to pull PSIOs up to LDO5 if desired. To do this, one will need to place jumpers at the locations JP5, JP6, and JP7.





# XR77129EVB-DEMO-1

## Universal PMIC 40V Quad Output Digital PWM/PFM Demo Board

### EVALUATION BOARD CONNECTIONS

The following picture illustrates how VIN supplied from a test bench DC power supply and instruments attached to the outputs would be connected to the XR77129EVB-DEMO-1 board.

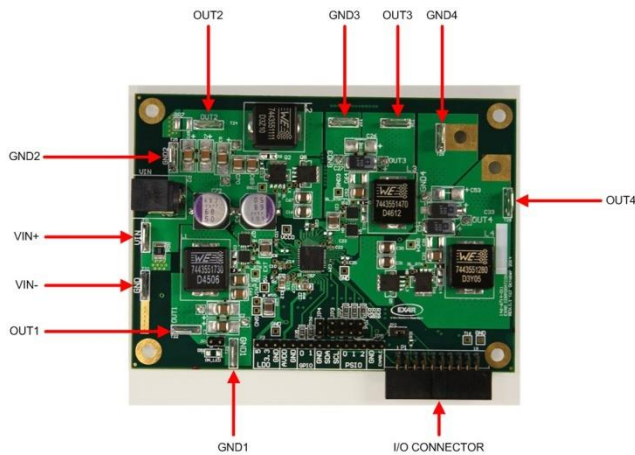

### INTERFACE BOARD CONNECTIONS

The following picture illustrates connections on the interface board - XR77EVB-INT-1. Its primary task is to provide interface between the Arduino controller board and EVB. In addition, as explained in the subsequent sections, it can be used to make connection between XCM and EVB using 10-wire ribbon cable.

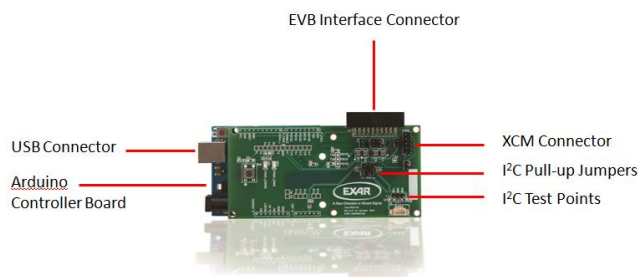

### USING EXAR CONFIGURATION MODULE (XCM) TO COMMUNICATE WITH THE EVALUATION BOARD

It is possible to use the XCM (firmware version v62) to communicate with the XR77129EVB-DEMO-1 board. PA 5.2 supports XCM. The main task will be connecting XCM to the evaluation board.

### Using Interface Board

If the interface board is available use following steps:

- Make sure no Arduino controller board is connected to the interface board
- Remove I2C pull-up jumpers at location JP6 and JP7 (need to be open in all positions)
- If the 10-wire ribbon cable is available connect the XCM to the interface board as shown below



- Use I2C pull-up resistors on XCM (install headers at the locations JP2 and JP3 shorting pins 2 and 3)
- If 10-wire ribbon cable is not available use 3-wire connection between JP4 pins 1-3 on XCM (pin 1 – SCL; pin 2 – GND; pin 3 – SDA) to test points T23 (SCL), T24 (GND) and T25 (SDA) on the interface board. Make a use of the silkscreen labels on both boards.
- Connect the interface board and the evaluation board as shown above.

### Wiring XCM directly to the Evaluation Board

Use 3-wire connection between JP4 pins 1-3 on the XCM (pin 1 – SCL; pin 2 – GND; pin 3 – SDA) to the P3 connector on the evaluation board, the pin 8 (GND), the pin 9 (SDA) and the pin 10 (SCL) on the interface board. Make a use of the silkscreen labels on both boards.



# XR77129EVB-DEMO-1

## Universal PMIC

### 40V Quad Output Digital PWM/PFM Demo Board

#### EVALUATION BOARD SCHEMATICS

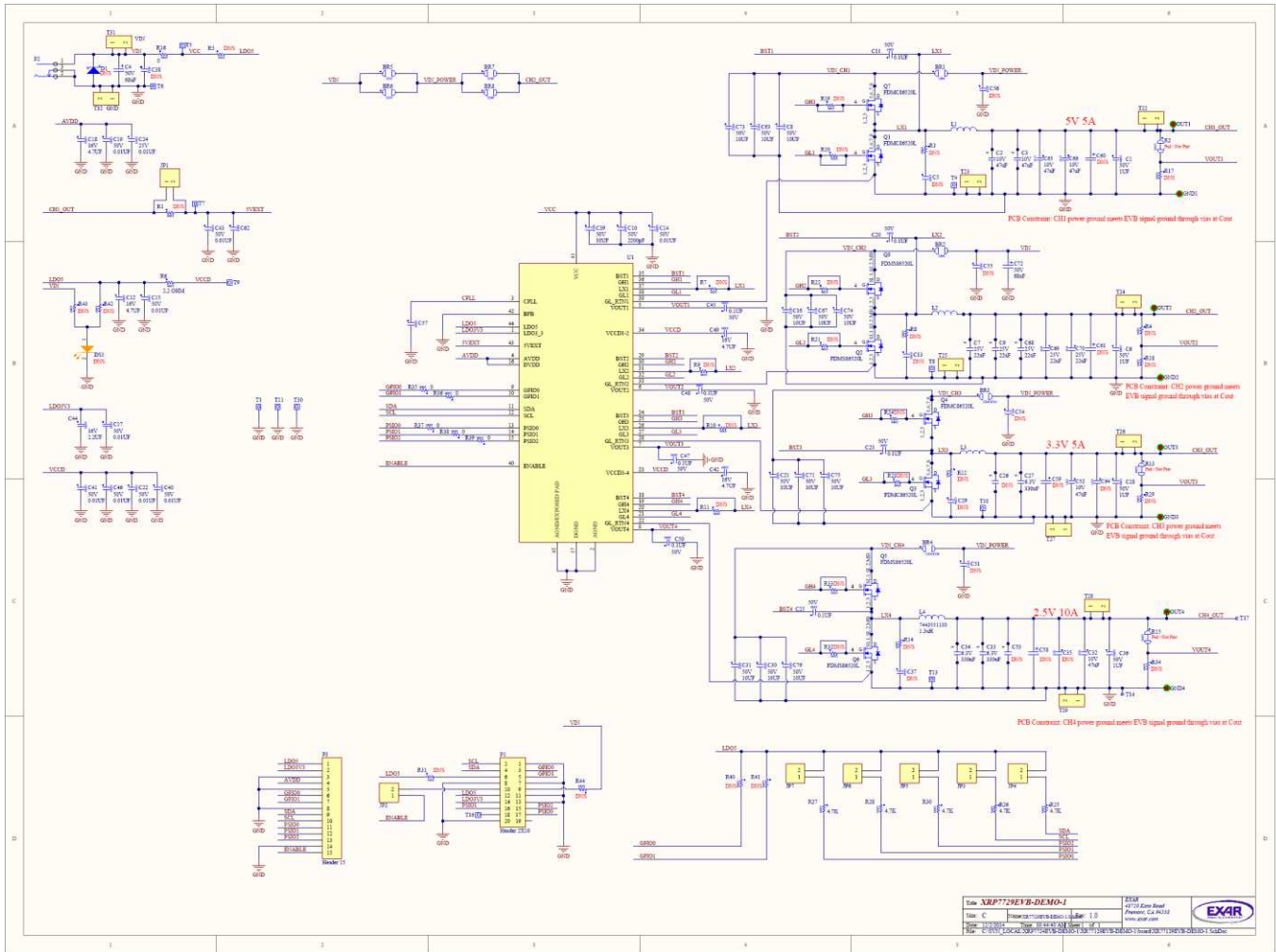





**BILL OF MATERIAL**

Ref.	Qty	Manufacturer	Part Number	Size	Component
	1	Exar Corporation	146-6714-011	4.40x3.15in	PCB
U1	1	Exar Corporation	XR77129	TQFN44	40V Quad Controller
Q1, Q3,Q4, Q7	4	Fairchild	FDMC86520L	Power 56	N-Channel Power Trench MOSFET, 60V
Q2, Q5, Q6, Q8	4	Fairchild	FDMS86520L	Power 56	N-Channel Power Trench MOSFET, 60V
L1	1	Würth Elektronik	7443551730	13.0X12.8mm	Inductor 7.3uH, 5.9mΩ, 12.0A
L2	1	Würth Elektronik	7443551111	13.0X12.8mm	Inductor 11.3uH, 9.1mΩ, 11.0A
L3	1	Würth Elektronik	7443551470	13.0X12.8mm	Inductor 4.7uH, 7.0mΩ, 13.0A
L4	1	Würth Elektronik	7443551280	13.0X12.8mm	Inductor 3.3uH, 1.8mΩ, 20.0A
C1, C6, C28, C36	4	Murata Corporation	GRM21BR71H105KA12L	0805	Ceramic Capacitor 1μF, 50V, X7R
C2, C3, C32, C52, C65, C66	6	Murata Corporation	GRM32ER71A476KE15L	1210	Ceramic Capacitor 47μF, 10V, X7R
C4, C72	2	Panasonic/Sanyo	50SVPF68M	F12	OSCON Capacitor 68μF, 50V
C7, C9, C68, C69, C70	5	Murata Corporation	GRM32ER71E226KE15L	1210	Ceramic Capacitor 22μF, 25V, X7R
C8, C16, C21, C30, C31, C39, C67	7	Murata Corporation	GRM32ER71H106KA12L	1210	Ceramic Capacitor 10μF, 50V, X7R
C10	1	Murata Corporation	GRM188R71H222KA01D	0603	Ceramic Capacitor 2200pF, 50V, X7R
C11, C20, C23, C25, C45, C47, C50	7	Murata Corporation	GRM188R71H104KA93D	0603	Ceramic Capacitor 0.1μF, 50V, X7R
C12, C18, C42, C49	4	Murata Corporation	GRM21BR71C475KA73	0805	Ceramic Capacitor 4.7μF, 16V, X7R
C14, C15, C17, C19, C22, C40, C41, C43, C46	9	Murata Corporation	GRM188R71H103KA01D	0603	Ceramic Capacitor 0.01μF, 50V, X7R
C24	1	Murata Corporation	GRM155R71H103KA88D	0402	Ceramic Capacitor 0.01μF, 50V, X7R
C27, C33, C34	3	Panasonic/Sanyo	6TPF330M9L	7343 D3L	POSCAP Capacitor 330μF, 6.3V, 9mΩ



# XR77129EVB-DEMO-1

## Universal PMIC 40V Quad Output Digital PWM/PFM Demo Board

Ref.	Qty	Manufacturer	Part Number	Size	Component
C44	1	Murata Corporation	GRM21BR71C225KA12L	0805	Ceramic Capacitor 2.2 $\mu$ F, 16V, X7R
C57	1	Murata Corporation	GRM155R71H222KA01D	0402	Ceramic Capacitor 2200pF, 50V, X7R
C62	1	Murata Corporation	GRM31CR71C106KAC7L	1206	Ceramic Capacitor 10 $\mu$ F, 16V, X7R
C63, C71, C73, C74, C75, C76	6	Murata Corporation	GRM31CR61H106KA12L	1206	Ceramic Capacitor 10 $\mu$ F, 50V, X5R
BR1, BR2	2	Vishay Dale	CRCW12060000Z0EAHP	1206	RES 0 $\Omega$ , 1/2W, SMD
BR3, BR4, BR5, BR6	2	Vishay Dale	CRCW12100000Z0EA	1210	RES 0 $\Omega$ , 1/2W, SMD
R4	1	Panasonic	ERJ-3EKF1102V	0603	RES 11k $\Omega$ , 1/10W, 1%, SMD
R6	1	Panasonic	ERJ-3RQF2R2V	0603	RES 2.2 $\Omega$ , 1/10W, 1%, SMD
R16, R35, R36, R37, R38, R39	6	Panasonic	ERJ-6GEY0R00V	0805	RES 0 $\Omega$ , 1/8W, SMD
R18	1	Panasonic	ERJ-3EKF1001V	0603	RES 1k $\Omega$ , 1/10W, 1%, SMD
R25, R26, R27, R28, R30	5	Panasonic	ERJ-3EKF4701V	0603	RES 4.7k $\Omega$ , 1/10W, 1%, SMD
JP1, JP2, JP3, JP4, JP5, JP6, JP7	7	Würth Elektronik	61300211121	0.20x0.10in	Connector, Male Header, 2 Positions, 100mil Spacing, Vertical, TH
P1	1	Sullins Connector Solutions	SFH11-PBPC-D10-RA-BK	1.20x0.55in	Connector, Female Header, 20 Positions, 100mil Spacing, RA, TH
P2	1	Switchcraft	RAPC722X	0.60x0.40in	Connector, Power Jack Mini R/A, T/H
P3	1	Würth Elektronik	61301511121	1.50x0.10in	Connector, Male Header, 15 Positions, 100mil Spacing, Vertical, TH
T4, T8, T10, T11, T13, T30	6	Würth Elektronik	61300111121	0.10x0.10in	Square Test Posts, TH
T22, T23, T24, T25, T26, T27, T28, T29, T31, T32	10	Würth Elektronik	7471287	0.32x0.10in	Mounting Tabs
GND1, GND2, GND3, GND4, OUT1, OUT2, OUT3, OUT4	8	Vector Electronics	K30C/M		Round Test Posts, TH



EVALUATION BOARD LAYOUT

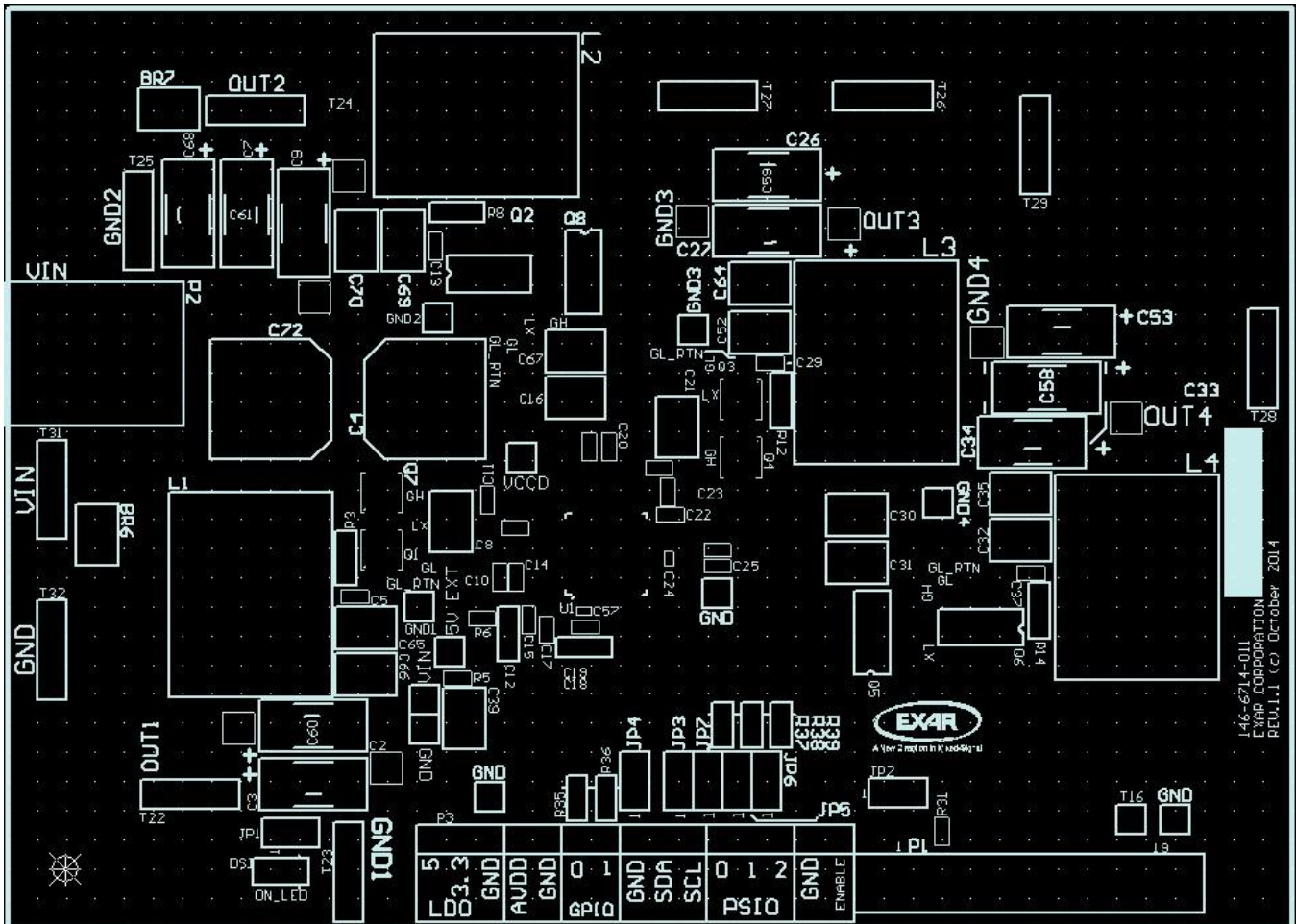

Figure 2 Component Placement – Top Side





**XR77129EVB-DEMO-1**  
**Universal PMIC**  
**40V Quad Output Digital PWM/PFM Demo Board**

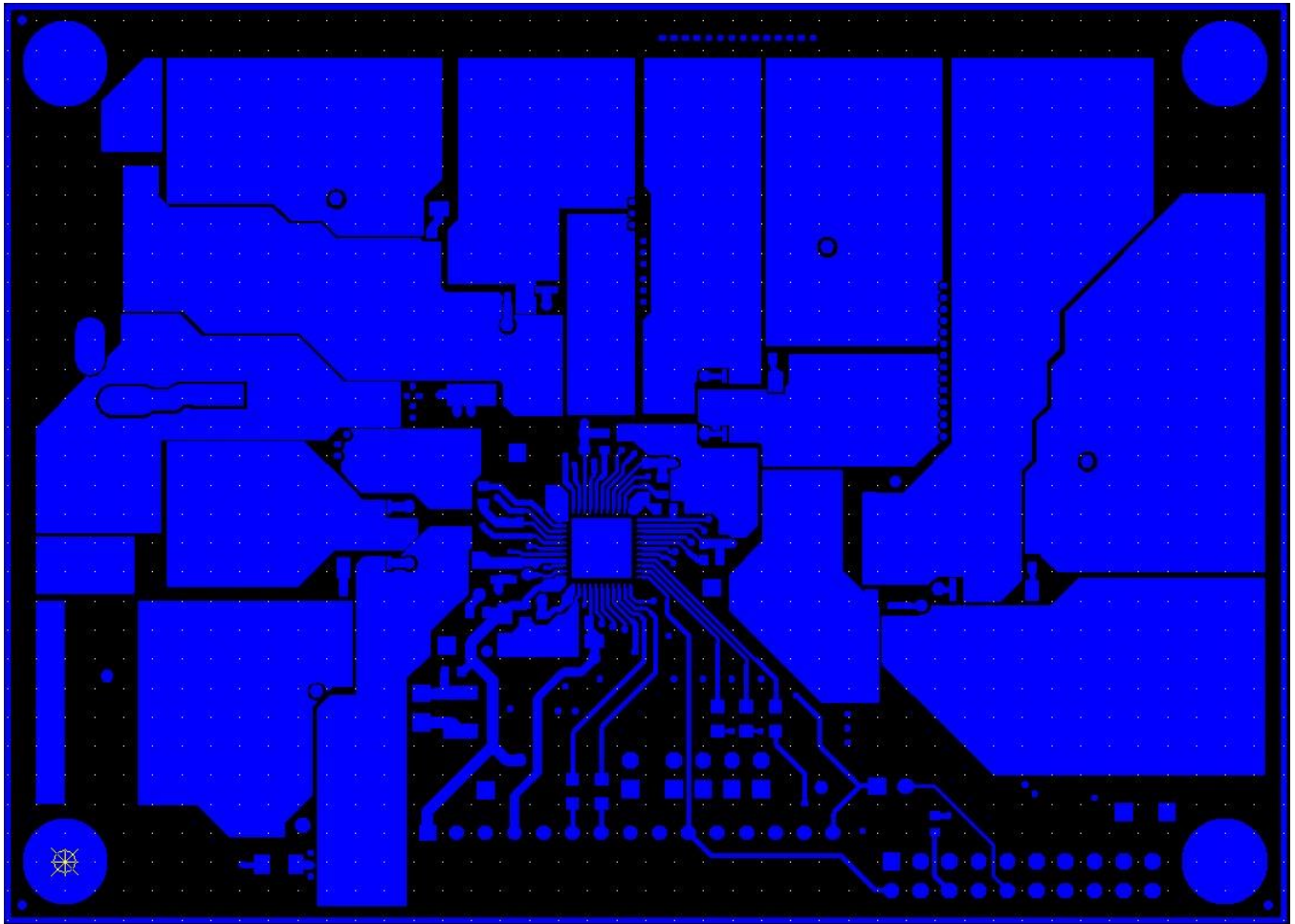

Figure 3 Layout – Top Layer



**XR77129EVB-DEMO-1**  
**Universal PMIC**  
**40V Quad Output Digital PWM/PFM Demo Board**

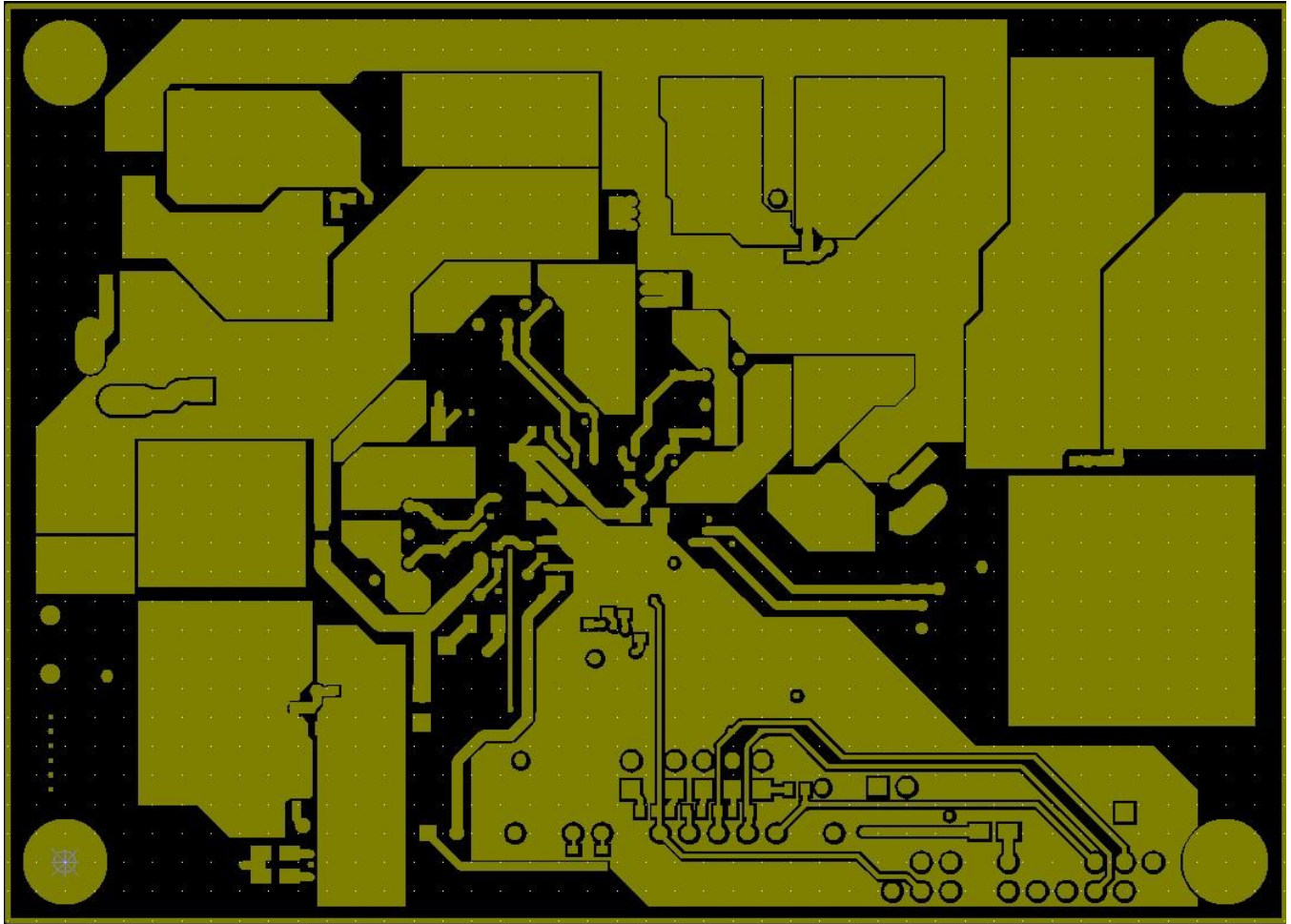

Figure 4 Layout – Bottom Layer



**XR77129EVB-DEMO-1**  
**Universal PMIC**  
**40V Quad Output Digital PWM/PFM Demo Board**

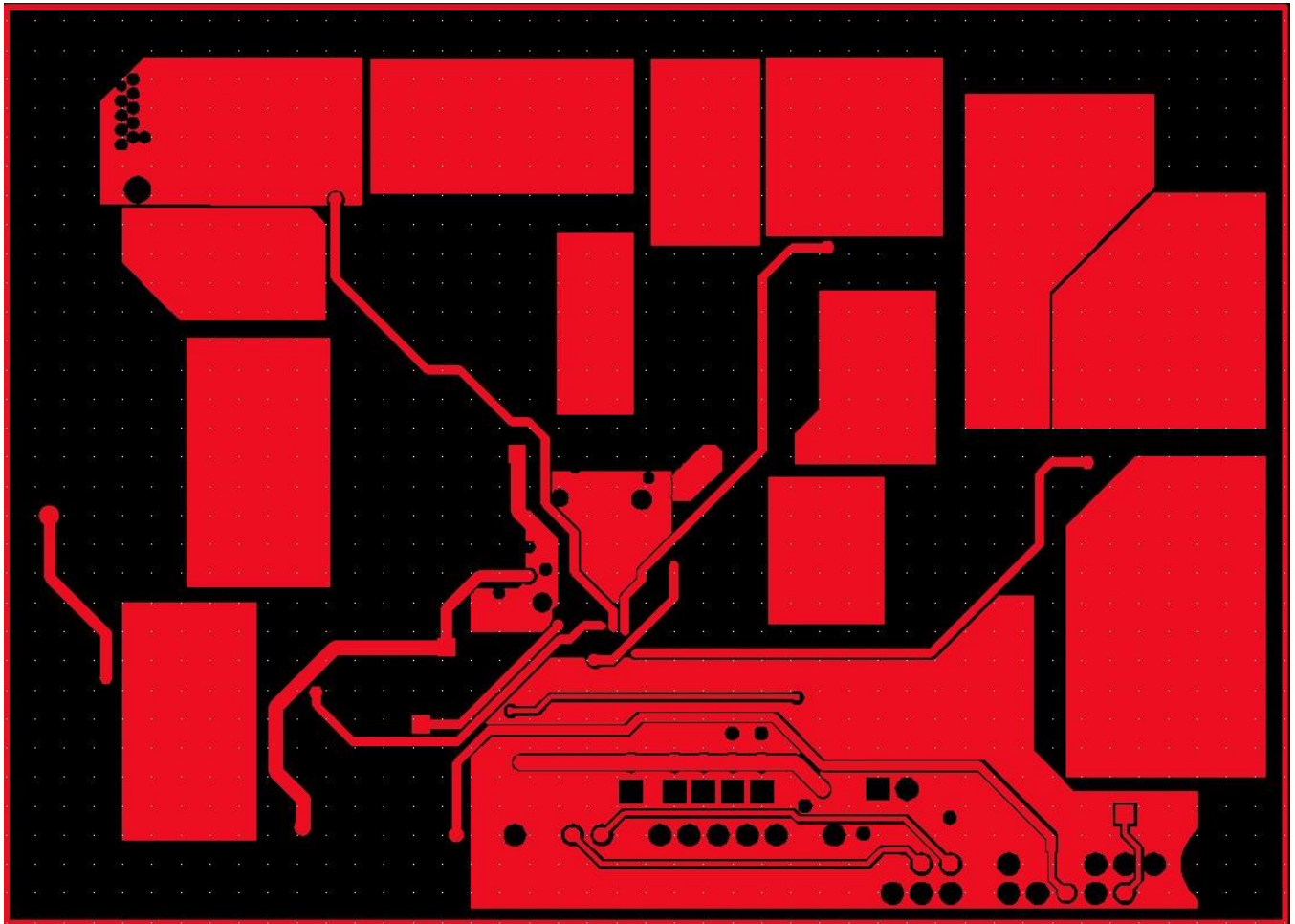

Figure 5 Layout – Middle Layer 1





**XR77129EVB-DEMO-1**  
**Universal PMIC**  
**40V Quad Output Digital PWM/PFM Demo Board**

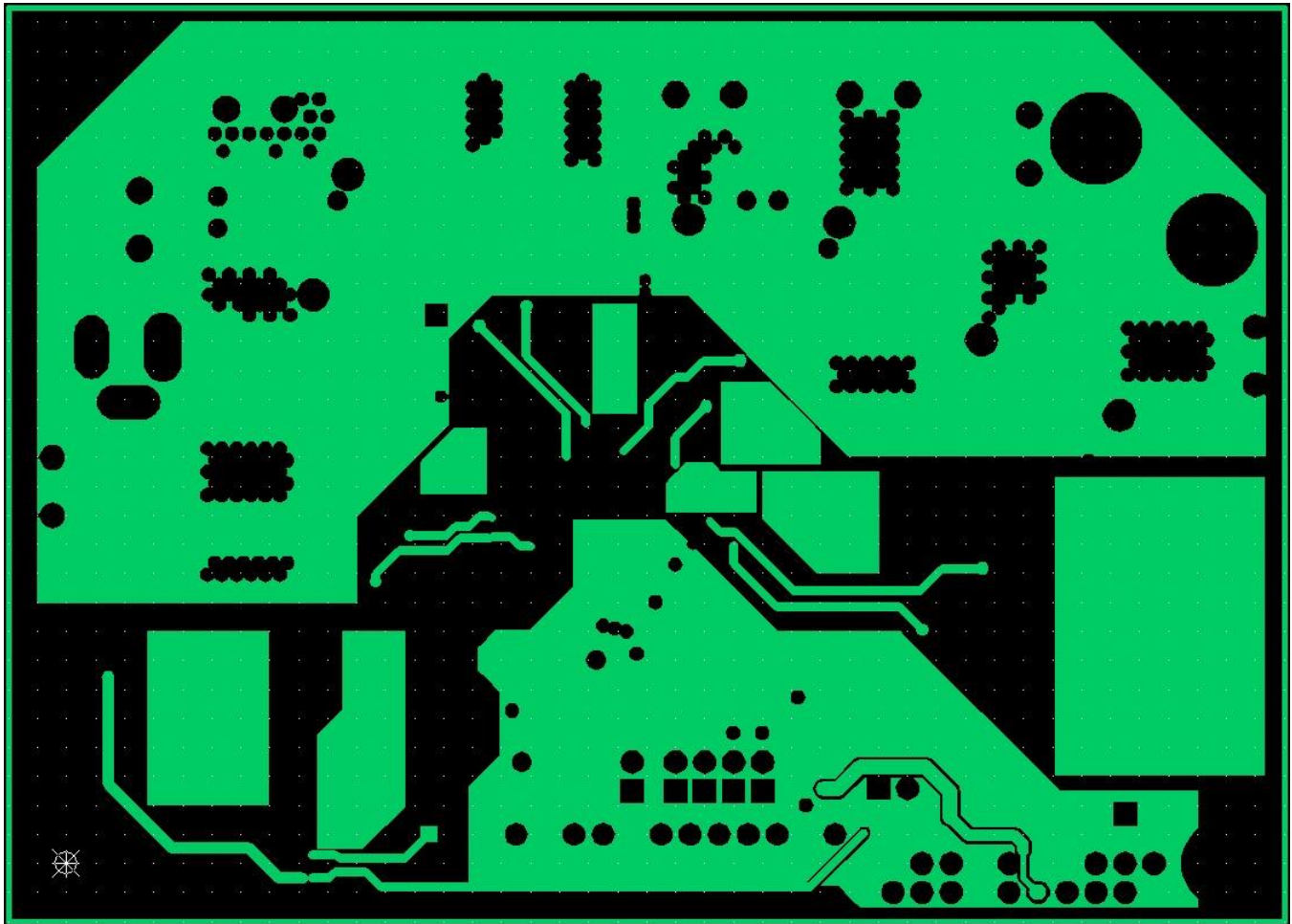

Figure 6 Layout – Middle Layer 2



**XR77129EVB-DEMO-1**  
**Universal PMIC**  
**40V Quad Output Digital PWM/PFM Demo Board**

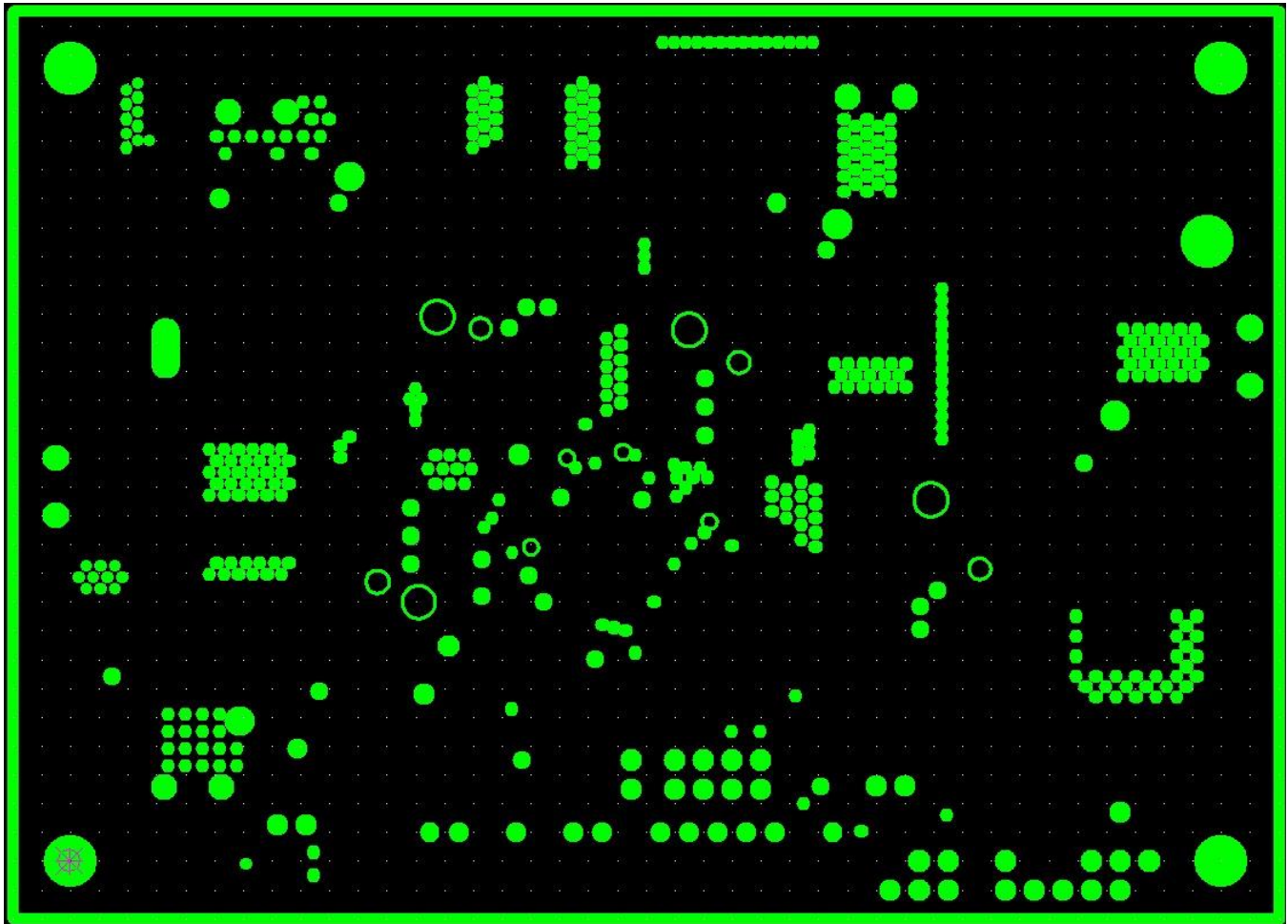

Figure 7 Layout – Signal Ground Plane (there are two GND planes; one is shown, the other one is identical)







**BILL OF MATERIAL - XR77EVB-INT-1 ARDUINO CONTROLLER INTERFACE BOARD**

Ref.	Qty	Manufacturer	Part Number	Size	Component
	1	Exar Corporation	146-6703-01	4.40x2.10	PCB
DS1	1	Würth Elektronik	150120RS75000	1206	SMD Red Chip LED
DS2	1	Würth Elektronik	150120VS75000	1206	SMD Green Chip LED
C1, C2, C3, C4	4	Vishay Sprague	293D226X9010B2TE3	B	Tantalum Capacitor 22 $\mu$ F, 10V, 10%
R1, R5, R6, R9	4	Panasonic	ERJ-6GEY0R00V	0805	RES 0 $\Omega$ , 1/8W, 5% SMD
R2, R3	2	Panasonic	ERJ-6GEYJ122V	0805	RES 1.2k $\Omega$ , 1/8W, 5%, SMD
R4, R7, R8	3	Panasonic	ERJ-6GEYJ472V	0805	RES 4.7k $\Omega$ , 1/8W, 5%, SMD
SW1	1	Würth Elektronik	430182050816	6x6mm	Tact Switch, SMD
CON5	1	Würth Elektronik	61301021121	0.50x0.20in	Connector, Male Header, 10 Positions, Dual Row, 100mil Spacing, Vertical, TH
JP1, JP2, JP3, JP4, JP5	5	Würth Elektronik	61300211121	0.20x0.10in	Connector, Male Header, 2 Positions, 100mil Spacing, Vertical, TH
JP6, JP7	2	Würth Elektronik	61300311121	0.30x0.10in	Connector, Male Header, 3 Positions, 100mil Spacing, Vertical, TH
P1	1	Würth Elektronik	612020235221	1.20x0.55in	Connector, Male Header, 20 Positions, Dual Row, 100mil Spacing, Shrouded, RA, TH
P2	1	Würth Elektronik	653104124022	11x6mm	Wire-to-Board Connector, Male, 4 Positions, 1.25mm Spacing, Shrouded, SMT
P_IOH1	1	Würth Elektronik	61301011121	1.00x0.10in	Connector, Male Header, 10 Positions, 100mil Spacing, Vertical, TH
P_POWER1, P_IOL1	2	Würth Elektronik	61300811121	0.80x0.10in	Connector, Male Header, 8 Positions, 100mil Spacing, Vertical, TH
P_AD1	1	Würth Elektronik	61300611121	0.60x0.10in	Connector, Male Header, 6 Positions, 100mil Spacing, Vertical, TH
T23, T24, T25	3	Würth Elektronik	61300111121	0.10x0.10in	Square Test Posts, TH



**DOCUMENT REVISION HISTORY**

Revision	Date	Description
1.0.0	12/04/2014	Initial release of document

**BOARD REVISION HISTORY**

Board Revision	Date	Description
XR77129EVB-DEMO-1-01	12/04/14	Initial release of the evaluation board

**FOR FURTHER ASSISTANCE**

Email:

[customersupport@exar.com](mailto:customersupport@exar.com)

[powertechsupport@exar.com](mailto:powertechsupport@exar.com)

Exar Technical Documentation:

<http://www.exar.com/TechDoc/default.aspx?>

**EXAR CORPORATION**

**HEADQUARTERS AND SALES OFFICES**

48720 Kato Road

Fremont, CA 94538 – USA

Tel.: +1 (510) 668-7000

Fax: +1 (510) 668-7030

[www.exar.com](http://www.exar.com)



**NOTICE**

EXAR Corporation reserves the right to make changes to the products contained in this publication in order to improve design, performance or reliability. EXAR Corporation assumes no responsibility for the use of any circuits described herein, conveys no license under any patent or other right, and makes no representation that the circuits are free of patent infringement. Charts and schedules contained here in are only for illustration purposes and may vary depending upon a user’s specific application. While the information in this publication has been carefully checked; no responsibility, however, is assumed for inaccuracies.

EXAR Corporation does not recommend the use of any of its products in life support applications where the failure or malfunction of the product can reasonably be expected to cause failure of the life support system or to significantly affect its safety or effectiveness. Products are not authorized for use in such applications unless EXAR Corporation receives, in writing, assurances to its satisfaction that: (a) the risk of injury or damage has been minimized; (b) the user assumes all such risks; (c) potential liability of EXAR Corporation is adequately protected under the circumstances.

Reproduction, in part or whole, without the prior written consent of EXAR Corporation is prohibited.