



Chipsmall Limited consists of a professional team with an average of over 10 year of expertise in the distribution of electronic components. Based in Hongkong, we have already established firm and mutual-benefit business relationships with customers from,Europe,America and south Asia,supplying obsolete and hard-to-find components to meet their specific needs.

With the principle of "Quality Parts,Customers Priority,Honest Operation,and Considerate Service",our business mainly focus on the distribution of electronic components. Line cards we deal with include Microchip,ALPS,ROHM,Xilinx,Pulse,ON,Everlight and Freescale. Main products comprise IC,Modules,Potentiometer,IC Socket,Relay,Connector.Our parts cover such applications as commercial,industrial, and automotives areas.

We are looking forward to setting up business relationship with you and hope to provide you with the best service and solution. Let us make a better world for our industry!



## Contact us

Tel: +86-755-8981 8866 Fax: +86-755-8427 6832

Email & Skype: info@chipsmall.com Web: www.chipsmall.com

Address: A1208, Overseas Decoration Building, #122 Zhenhua RD., Futian, Shenzhen, China





# 22V, 10A Synchronous Step Down COT Power Module

December 2014

Rev. 1A

## GENERAL DESCRIPTION

The XR79110 is a 10A synchronous step-down Power Module for point-of load supplies. A wide 5V to 22V input voltage range allows for single supply operation from industry standard 5V, 12V, and 19.6V rails.

With a proprietary emulated current mode Constant On-Time (COT) control scheme, the XR79110 provides extremely fast line and load transient response using ceramic output capacitors. It requires no loop compensation hence simplifying circuit implementation and reducing overall component count. The control loop also provides 0.35% load and 0.1% line regulation and maintains constant operating frequency. A selectable power saving mode allows the user to operate in discontinuous mode (DCM) at light current loads thereby significantly increasing the converter efficiency. With a 96% peak efficiency and 90% for loads as low as 100mA, the XR79110 is suitable for applications where low power losses are important.

A host of protection features, including over-current, over-temperature, short-circuit and UVLO, help achieve safe operation under abnormal operating conditions.

The XR79110 is available in a RoHS compliant, green/halogen free space-saving 72-pin 10x10x4mm QFN package with a 260°C lead solder temperature. With integrated controller, drivers, bootstrap diode and capacitor, MOSFETs, inductor, CIN and COUT, this solution allows the smallest possible 10A POL design.

## EVALUATION BOARD MANUAL

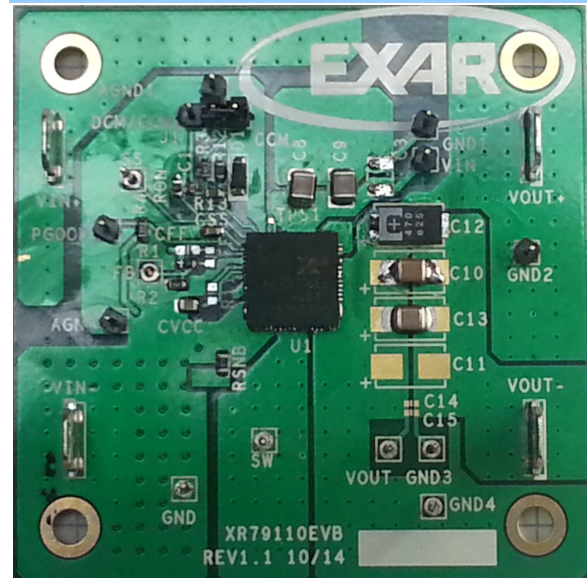

## FEATURES

- Controller, drivers, bootstrap diode and capacitor, MOSFETs, Inductor, CIN and COUT integrated in one package
- 10A Step Down Module
  - Wide 5V to 22V Input Voltage Range
  - $\geq 0.6V$  Adjustable Output Voltage
- Proprietary Constant On-Time Control
  - No Loop Compensation Required
  - Ceramic Output Cap. Stable operation
  - Programmable 200ns-2 $\mu$ s On-Time
  - Constant 400kHz-600kHz freq.
  - Selectable CCM or CCM/DCM Operation
- 72-pin 10x10x4mm QFN package 260C solder temp.

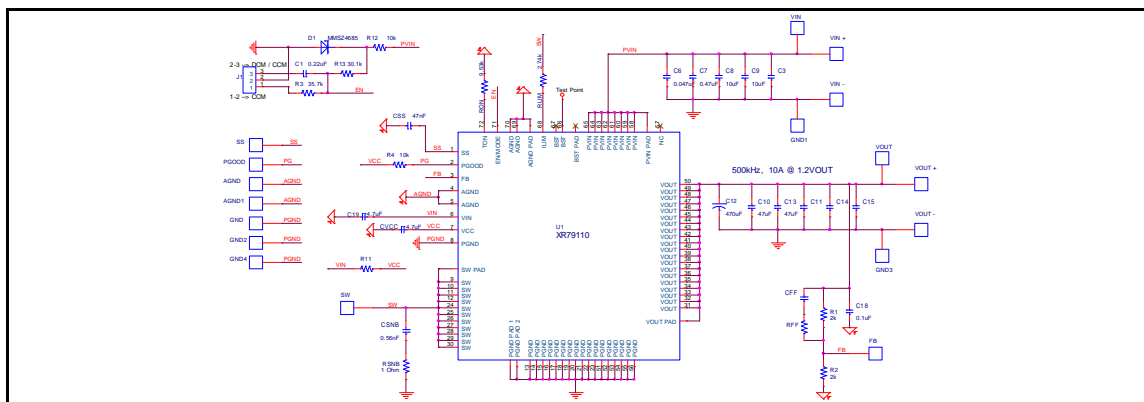

Fig. 1: XR79110 Evaluation Board Schematics



**22V, 10A Synchronous Step Down COT Power Module**

**PIN ASSIGNMENT**

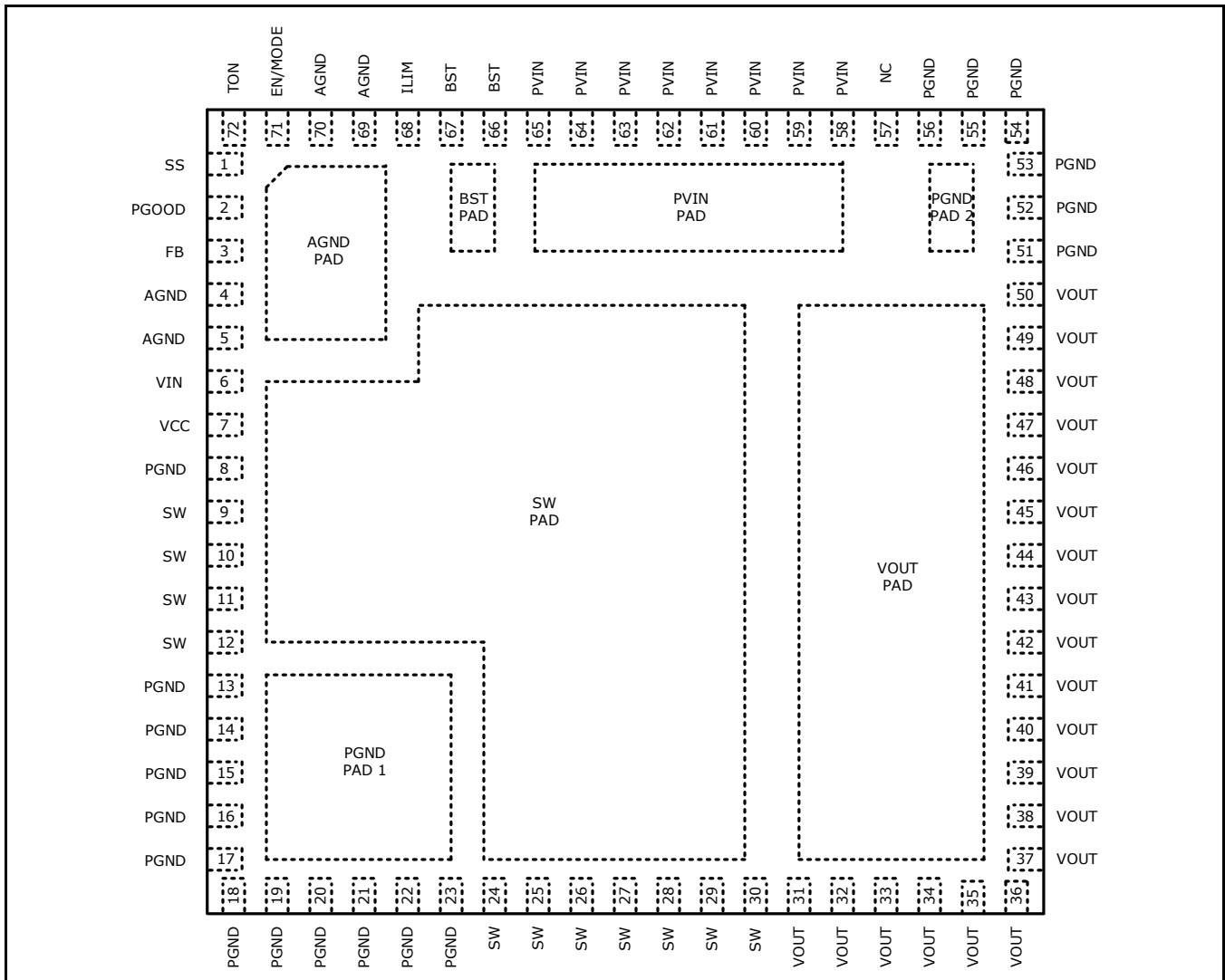

Fig. 2: XR79110 Pin Assignment

**22V, 10A Synchronous Step Down COT Power Module****PIN DESCRIPTION**

Pin No.	Pin Name	Type	Description
1	SS	A	Soft-start pin. Connect an external capacitor between SS and AGND to program the soft-start rate based on the 10uA internal source current.
2	PGOOD	OD, O	Power-good output. This open-drain output is pulled low when $V_{OUT}$ is outside the regulation.
3	FB	A	Feedback input to feedback comparator. Connect with a set of resistors to VOUT and AGND in order to program VOUT.
4, 5, 69, 70, AGND Pad	AGND	A	Analog ground. Control circuitry of the IC is referenced to this pin.
6	VIN	PWR	IC supply input. Provides power to internal LDO.
7	VCC	PWR	The output of LDO. Bypass with a 4.7uF capacitor to AGND. For operation from a 5V <sub>IN</sub> rail, VCC should be tied to VIN.
8	PGND	PWR	Controller low-side driver ground. Connect with a short trace to closest PGND pins or PGND pad.
13-23, 51-56, PGND pads	PGND	PWR	Ground of the power stage. Should be connected to the system's power ground plane.
9-12, 24-30, SW Pad	SW	PWR	Switching node. It is internally connected. Use thermal vias and/or sufficient PCB land area in order to heatsink the low-side FET and the inductor.
31-50, VOUT Pad	VOUT	PWR	Output of the power stage. Place the output filter capacitors as close as possible to these pins.
58-65, PVIN Pad	PVIN	PWR	Power stage input voltage. Place the input filter capacitors as close as possible to these pins.
66, 67, BST Pad	BST	A	Controller high-side driver supply pin. It is internally connected to SW via a 0.1uF bootstrap capacitor. Leave these pins floating.
68	ILIM	A	Over-current protection programming. Connect with a short trace to SW pins.
71	EN/MODE	I	Precision enable pin. Pulling this pin above 1.9V will turn the IC on and it will operate in Forced CCM. If the voltage is raised above 3.0V, then the IC will operate in DCM or CCM depending on load.
72	TON	A	Constant on-time programming pin. Connect with a resistor to AGND.

Type: A = Analog, I = Input, O = Output, I/O = Input/Output, PWR = Power, OD = Open-Drain

**ORDERING INFORMATION**

Refer to XR79110 datasheet and/or [www.exar.com](http://www.exar.com) for exact and up to date ordering information.

**22V, 10A Synchronous Step Down COT Power Module**

---

**USING THE EVALUATION BOARD****POWERING UP**

Connect the VIN+/VIN- with short/thick leads to power supply. Use test pins VIN and GND1 to monitor VIN+ and VIN- respectively. Connect VOUT+/VOUT- with short/thick leads to an electronic load. Use test pins VOUT and GND3 to monitor VOUT+ and VOUT- respectively. Apply 12V using the power supply. The XR79110EVB should power up and regulate the output at 1.2V. Input voltage range is from 5V to 22V. Maximum rated current for XR79110 is 10A.

**JUMPER J1**

If the jumper is set to CCM position the Module will operate in "forced CCM".

If the Jumper is set to DCM/CCM position the Module will operate in DCM at light load. Transition from DCM to CCM is at approximately 2.5A.

**OPERATION FROM A 5V RAIL ( $V_{IN}=4.5V-5.5V$ )**

For operation from a 5V rail it is recommended to tie output of the LDO to  $V_{IN}$  by populating R11 with a 0 $\Omega$  resistor. This enhances the operation of the drivers at  $V_{IN}<5V$ . Please remember to remove R11 for operation at higher  $V_{IN}$ .

**PROGRAMMING THE OUTPUT VOLTAGE**

$V_{OUT}$  can be programmed by changing R1 according to:

$$R1 = R2 \times \left( \frac{V_{OUT}}{0.6} - 1 \right)$$

Note that capacitor C12 has a voltage rating of 2.5V. Remove C12 when programming  $V_{OUT}>2.5V$ .





**22V, 10A Synchronous Step Down COT Power Module**

**XR79110EVB BILL OF MATERIAL**

Reference Designator	Qty.	Manufacturer	Manufacturer Part Number	Size	Component
PCB	1	Exar	XR79110		XR79110 Evaluation kit
U1	1	Exar	XR79110	QFN	Synchronous Step Down Power Module
D1	1	ON SEMI	MMSZ4685T1G	SOD-123	Diode Zener 3.6V, 500MW,
C1	1	MURATA	GRM155R71C224KA12D	0402	CERAMIC CAP., 0.22uF, 16V, X7R, 10%
C8,C9	2	MURATA	GRM32E71H106KA12L	1210	CERAMIC CAP. 10uF, 50V, X7R, 10%
C19, CVCC	2	MURATA	GRM21BR71C475KA73L	0805	CERAMIC CAP , 4.7uF, 16V, X7R, 10%
C6	1	MURATA	GRM155R71E473KA88D	0402	CERAMIC CAP., 0.047uF, 25V, X7R, 10%
C7	1	MURATA	GRM188R71E474KA12D	0603	CERAMIC AP. , 0.47uF, 25V, X7R, 10%
C12	1	PANASONIC	2R5TPE470M7	2917	CAP. POSCAP, 470uF,2.5 V, 7mOhm, 20%
C10,C13	2	MURATA	GRM32ER71A476KE15L	1210	CERAMIC CER, 47uF, 10V, X7R, 10%
CSNB	1	MURATA	GRM188R71H561KA01D	0603	CERAMIC CAP. 0.56 nF, 50V,X7R,10%
CSS	1	MURATA	GRM188R71H473KA61D	0603	CERAMIC CAP. 0.047uF, 50V,X7R,10%
C18	1	MURATA	GRM188R71H104KA93D	0603	CERAMIC CAP., 0.1uF, 50V, 10%, X7R
R4,R12	2	PANASONIC	ERJ-3EKF1002V	0603	Resistor 10.0K Ohm, 1/10W, 1%
R13	1	PANASONIC	ERJ-3EKF3012V	0603	Resistor 30.1K Ohm, 1/10W,1%,SMD
R3	1	PANASONIC	ERJ-3EKF3572V	0603	Resistor 35.7K Ohm, 1/10W, 1%, SMD
R1,R2	2	PANASONIC	ERA-3YEB202V	0603	Resistor 2.0K Ohm, 1/10W, 0.1%, SMD
RLIM	1	PANASONIC	ERJ-3EKF2741V	0603	Resistor 2.74K Ohm, 1/10W,1%, SMD
RON	1	PANASONIC	ERJ-3EKF9531V	0603	Resistor 9.53K Ohm, 1/10W,1%, SMD
RSNB		PANASONIC	ERJ-6RQF1R0V	0603	Resistor 1.0 Ohm,1/8W,1%,SMD
J1	1	Würth Elektronik	61300311121		3-PIN CONNECTOR
VIN+, VOUT+, VIN-,VOUT- AGND1,SS,PGOOD,FB,AGND, GND,SW,GND1,VIN,GND2, VOUT, GND3,GND4	4 13	Würth Elektronik	7471287 61300111121		CONNECTOR BLADE TERMINAL SINGLE Test Point Post



22V, 10A Synchronous Step Down COT Power Module

EVALUATION BOARD LAYOUT

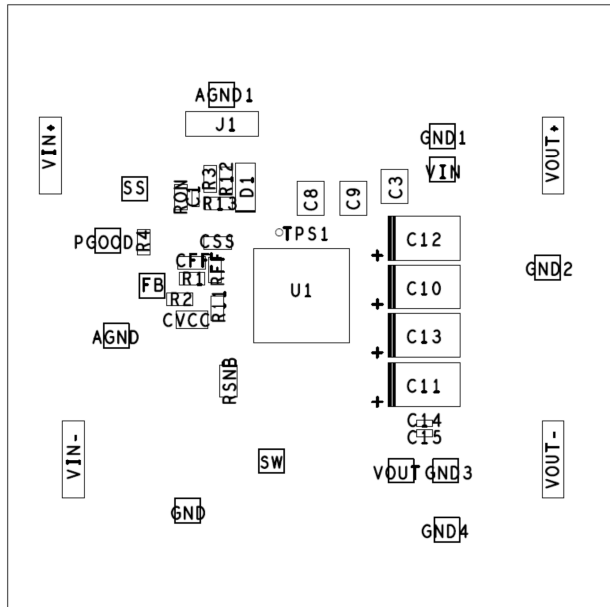

Fig. 3: Assembly Top

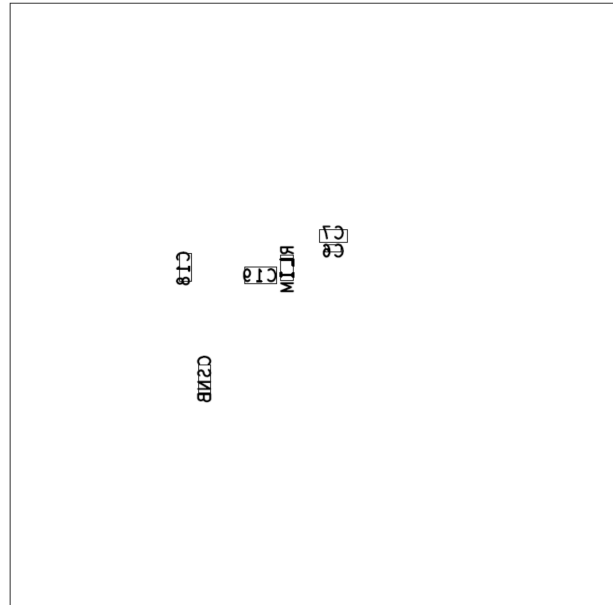

Fig. 4: Assembly Bottom

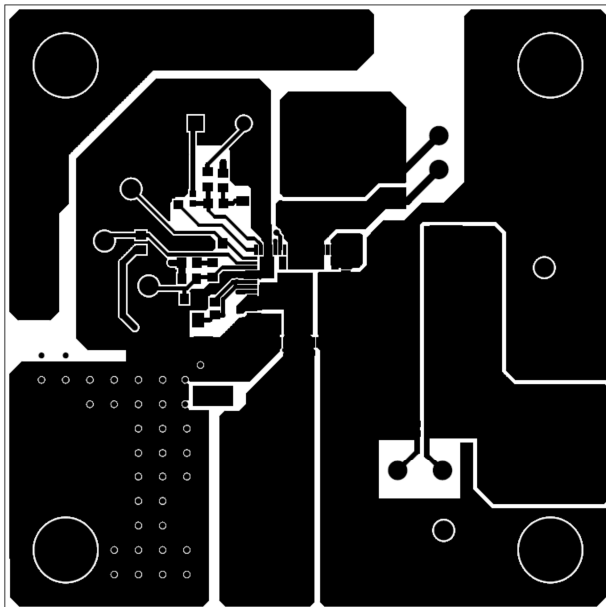

Fig. 5: Top

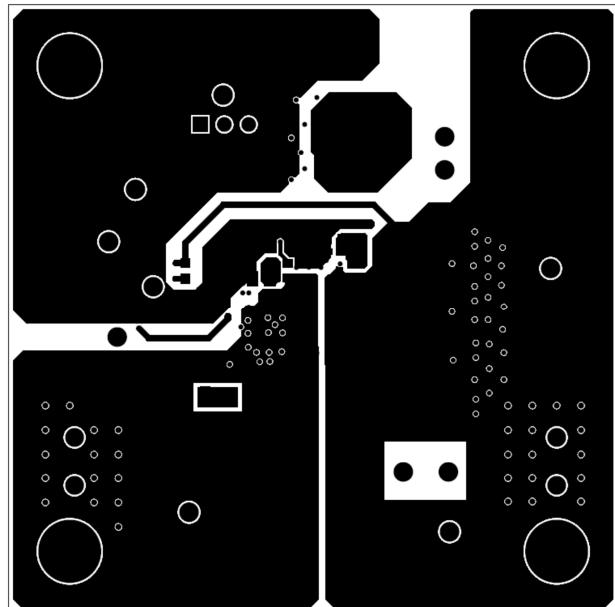

Fig. 6: Bottom





22V, 10A Synchronous Step Down COT Power Module

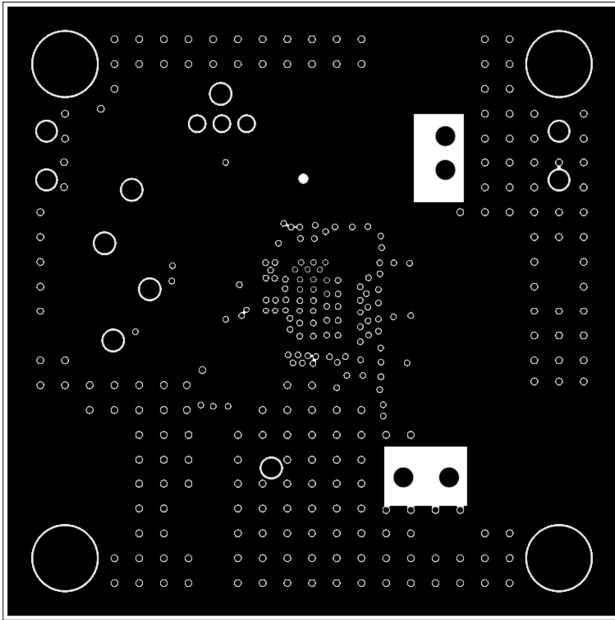

Fig. 7: Layer 2, GND 1

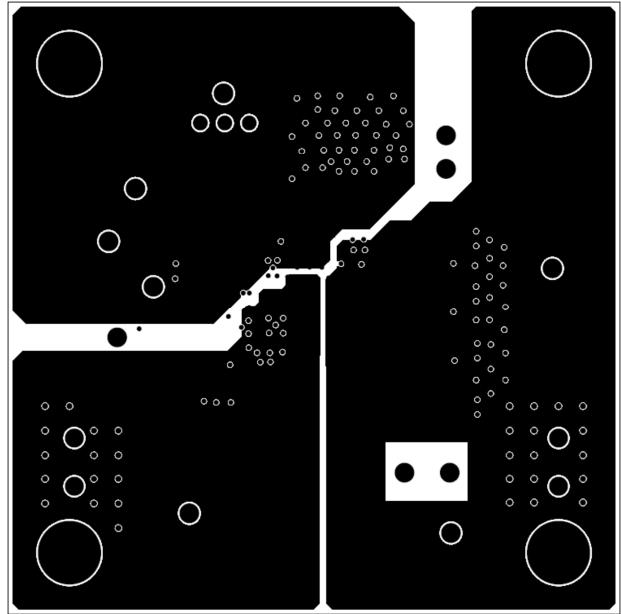

Fig. 8: Layer 3, VCC1

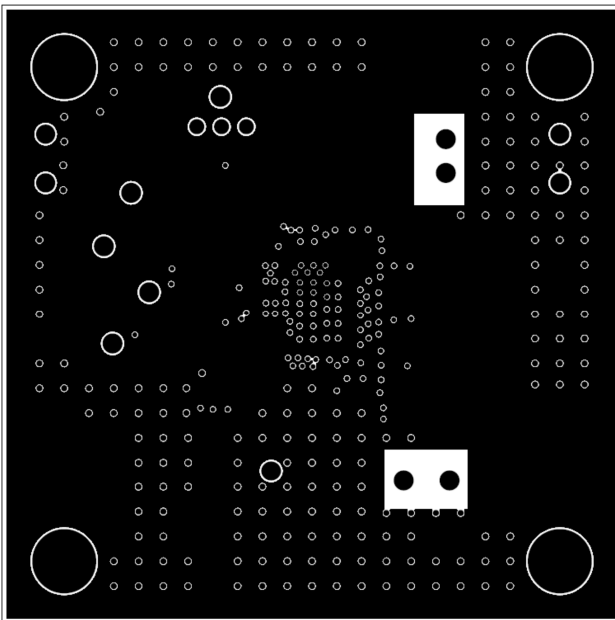

Fig. 9: Layer 4, GND 2

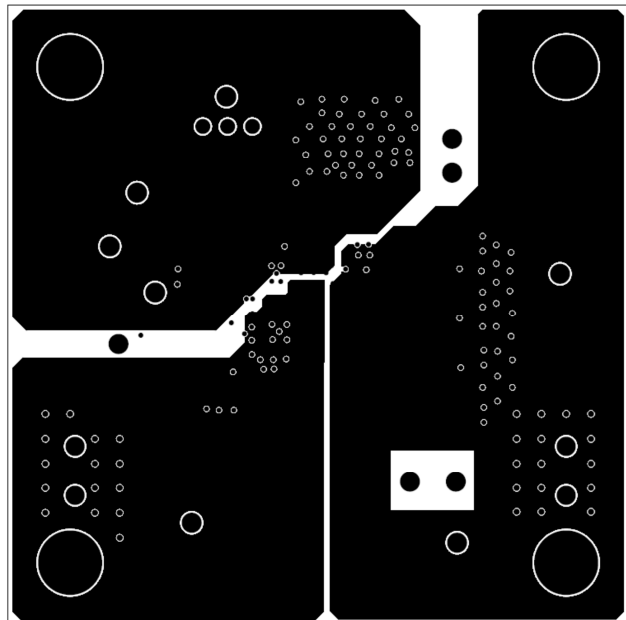

Fig. 10: Layer 5, VCC2



**22V, 10A Synchronous Step Down COT Power Module**

**DOCUMENT REVISION HISTORY**

Revision	Date	Description
1A	12/12/14	Initial release of document

**BOARD REVISION HISTORY**

Board Revision	Date	Description
REV 1.1	12/12/14	Initial release of evaluation board

**FOR FURTHER ASSISTANCE**

Email:

[customersupport@exar.com](mailto:customersupport@exar.com)

[powertechsupport@exar.com](mailto:powertechsupport@exar.com)

Exar Technical Documentation:

<http://www.exar.com/TechDoc/>

**EXAR CORPORATION**

**HEADQUARTERS AND SALES OFFICES**

48720 Kato Road

Fremont, CA 94538 – USA

Tel.: +1 (510) 668-7000

Fax: +1 (510) 668-7030

[www.exar.com](http://www.exar.com)



**NOTICE**

EXAR Corporation reserves the right to make changes to the products contained in this publication in order to improve design, performance or reliability. EXAR Corporation assumes no responsibility for the use of any circuits described herein, conveys no license under any patent or other right, and makes no representation that the circuits are free of patent infringement. Charts and schedules contained herein are only for illustration purposes and may vary depending upon a user's specific application. While the information in this publication has been carefully checked; no responsibility, however, is assumed for inaccuracies.

EXAR Corporation does not recommend the use of any of its products in life support applications where the failure or malfunction of the product can reasonably be expected to cause failure of the life support system or to significantly affect its safety or effectiveness. Products are not authorized for use in such applications unless EXAR Corporation receives, in writing, assurances to its satisfaction that: (a) the risk of injury or damage has been minimized; (b) the user assumes all such risks; (c) potential liability of EXAR Corporation is adequately protected under the circumstances.

Reproduction, in part or whole, without the prior written consent of EXAR Corporation is prohibited.