



Chipsmall Limited consists of a professional team with an average of over 10 year of expertise in the distribution of electronic components. Based in Hongkong, we have already established firm and mutual-benefit business relationships with customers from,Europe,America and south Asia,supplying obsolete and hard-to-find components to meet their specific needs.

With the principle of “Quality Parts,Customers Priority,Honest Operation,and Considerate Service”,our business mainly focus on the distribution of electronic components. Line cards we deal with include Microchip,ALPS,ROHM,Xilinx,Pulse,ON,Everlight and Freescale. Main products comprise IC,Modules,Potentiometer,IC Socket,Relay,Connector.Our parts cover such applications as commercial,industrial, and automotives areas.

We are looking forward to setting up business relationship with you and hope to provide you with the best service and solution. Let us make a better world for our industry!



## Contact us

Tel: +86-755-8981 8866 Fax: +86-755-8427 6832

Email & Skype: info@chipsmall.com Web: www.chipsmall.com

Address: A1208, Overseas Decoration Building, #122 Zhenhua RD., Futian, Shenzhen, China



### GENERAL DESCRIPTION

The XRP2525 and XRP2526 devices are respectively single and dual channel integrated high-side power distribution switches with independent enables and fault flags. A wide 1.8V to 5.5V input voltage range allows for operations from industry standard 1.8V, 3.3V and 5V power rails.

Optimized for USB  $V_{BUS}$  power distribution, the XRP2525 and XRP2526 are compliant with the latest USB 3.0 specification and can be used in any self or bus powered USB applications. The power-switch rise and fall times are controlled to minimize current surges during turn on/off.

The XRP2525 and XRP2526 are pin and function compatible to respectively Exar's SP2525A and SP2526A.

Built-in over current, under voltage lockout (UVLO), reverse current and over temperature protections insure safe operations under abnormal operating conditions.

XRP2525 and XRP2526 are offered in a RoHS compliant "green"/halogen free 8-pin NSOIC package.

### APPLICATIONS

- Self Powered USB 2.0 and 3.0 Hubs
- USB Compliant  $V_{BUS}$  Power Distribution
- Audio-Video Equipments
- Generic Power Switching

### FEATURES

- **Single/ Dual Channel Current Switch**
  - 900mA per channel capable
  - 1.15A Over-current Limit
  - 1.8V to 5.5V Input Voltage Range
- **USB 2.0/ 3.0 Compliant**
- **Active High or Low Individual Enable**
- **Individual Channel Fault Flag Indicator**
- **Under voltage Lockout, Reverse Current and Thermal Shutdown Protection**
- **RoHS Compliant, Green/ Halogen Free 8-Pin NSOIC Package**

### TYPICAL APPLICATION DIAGRAM

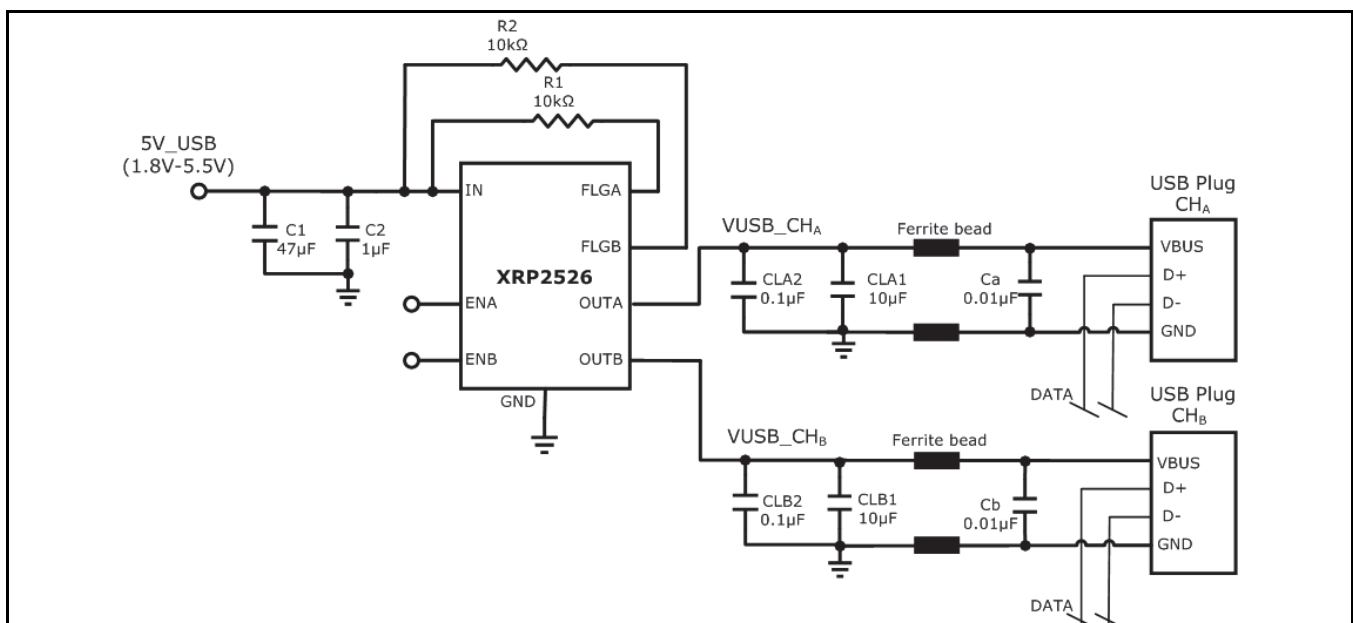

Fig. 1: XRP2526 Application Diagram



**ABSOLUTE MAXIMUM RATINGS**

These are stress ratings only and functional operation of the device at these ratings or any other above those indicated in the operation sections of the specifications below is not implied. Exposure to absolute maximum rating conditions for extended periods of time may affect reliability.

- V<sub>IN</sub>..... -0.3V to 7.0V
- V<sub>EN</sub>, V<sub>FLG</sub> ..... 7.0V
- Storage Temperature..... -65°C to 150°C
- Power Dissipation ..... Internally Limited
- Lead Temperature (Soldering, 10 sec) ..... 300°C
- ESD Rating (HBM - Human Body Model) ..... 2kV
- ESD Rating (MM - Machine Model) .....200V

**OPERATING RATINGS**

- Input Voltage Range V<sub>IN</sub>..... 1.75V to 5.5V
- Junction Temperature Range .....-40°C to 125°C
- Thermal Resistance  $\theta_{JA}$  .....128.4°C/W

**ELECTRICAL SPECIFICATIONS**

Specifications are for an Operating Junction Temperature of T<sub>J</sub> = 25°C only; limits applying over the full Operating Junction Temperature range are denoted by a “•”. Minimum and Maximum limits are guaranteed through test, design, or statistical correlation. Typical values represent the most likely parametric norm at T<sub>J</sub> = 25°C, and are provided for reference purposes only. Unless otherwise indicated, 1.8V to 5.5V, C<sub>IN</sub> = 47µF//1µF, C<sub>OUT</sub> = 10µF, T<sub>J</sub> = -40°C to 125°C.

| Parameter                                      | Min. | Typ.                  | Max. | Units | Conditions   |
|--|------|-----------------------|------|-------|--|
| Input Supply Voltage                           | 1.8  |                       | 5.5  | V     | •  |
| Input Quiescent Current                        |      | 80                    | 150  | µA    | • XRP2526 (Both Channels enabled)<br>V <sub>IN</sub> =5V, I <sub>OUT1</sub> = I <sub>OUT2</sub> =0mA |
| Input Quiescent Current                        |      | 52                    | 100  | µA    | • XRP2525 & XRP2526 (1 Channel enabled)<br>V <sub>IN</sub> =5V, I <sub>OUT1</sub> =0mA               |
| Input Shutdown Current                         |      |                       | 3    | µA    | • V <sub>IN</sub> =5V, Channel(s) disabled   |
| Maximum Output Current per channel             | 900  |                       |      | mA    | • XRP2525 and XRP2526  |
| Output Leakage Current                         |      |                       | 10   | µA    | V <sub>IN</sub> =5V, V <sub>OUT</sub> =0V, Each channel, Switch off                                  |
| Reverse Leakage Current                        |      |                       | 10   | µA    | V <sub>IN</sub> =0V, V <sub>OUT</sub> =5V, Each channel, Switch off                                  |
| Output MOSFET Resistance                       |      | 80                    | 140  | mΩ    | • I <sub>OUT</sub> =0.3A, Each channel   |
| Output turn-on delay                           |      | 1000                  |      | µs    | V <sub>IN</sub> =5V, R <sub>L</sub> =10Ω, C <sub>OUT</sub> =1µF, each output                         |
| Output turn-on rise time                       |      | 2000                  | 4000 | µs    | V <sub>IN</sub> =5V, R <sub>L</sub> =10Ω, C <sub>OUT</sub> =1µF, each output                         |
| Output turn-off delay                          |      | 10                    | 20   | µs    | V <sub>IN</sub> =5V, R <sub>L</sub> =10Ω, C <sub>OUT</sub> =1µF, each output                         |
| Output turn-off fall time                      |      | 22                    | 50   | µs    | V <sub>IN</sub> =5V, R <sub>L</sub> =10Ω, C <sub>OUT</sub> =1µF, each output                         |
| Current limit threshold                        | 0.90 | 1.15                  | 1.40 | A     | • V <sub>IN</sub> - V <sub>OUT</sub> =0.3V, Internally set   |
| Short Circuit Current Limit                    |      | 0.66xI <sub>LIM</sub> |      | A     | V <sub>OUT</sub> =0V   |
| Output Voltage Short Circuit Detect Threshold  |      | 925                   |      | mV    | Operates in short circuit current limit mode when output voltage is below threshold.                 |
| Safe Operating Area (SOA) Current Limit        |      | 3                     |      | A     |  |
| Over temperature shutdown threshold            |      | 135                   |      | °C    | Temperature rising   |
| Over temperature shutdown threshold hysteresis |      | 10                    |      | °C    | Temperature decreasing   |
| Under-voltage lockout threshold                | 1.55 | 1.68                  | 1.75 | V     | V <sub>IN</sub> rising or falling  |
| Under-voltage lockout hysteresis               |      | 50                    |      | mV    |  |
| FLG output logic low voltage                   |      | 100                   | 250  | mV    | I <sub>FLG</sub> =10mA, V <sub>IN</sub> =5.5V  |
| FLG output high leakage                        |      |                       | 1    | µA    |  |
| FLG blanking time                              |      | 10                    |      | ms    |  |
| EN input logic high voltage                    | 1.5  |                       |      | V     | •  |
| EN input logic low voltage                     |      |                       | 0.5  | V     | •  |
| EN input leakage current                       | -1   | 0                     | 1    | µA    | V <sub>EN</sub> =0V or V <sub>EN</sub> =5.5V   |

### BLOCK DIAGRAM

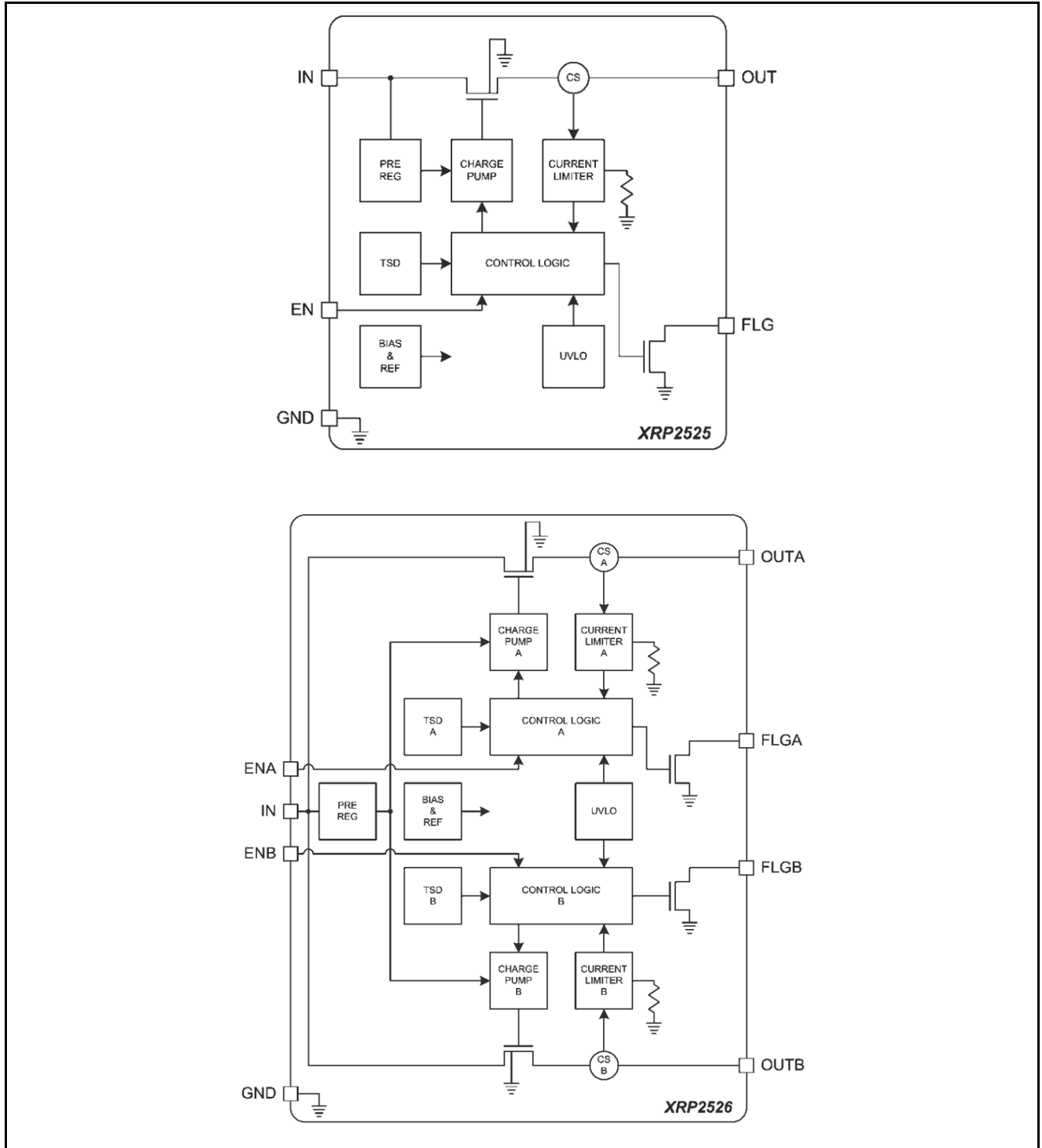

Fig. 2: XRP2525 and XRP2526 Block Diagrams



# XRP2525 - XRP2526

## Single/ Dual Channel USB 3.0 Power Distribution Switch

### PIN ASSIGNMENT

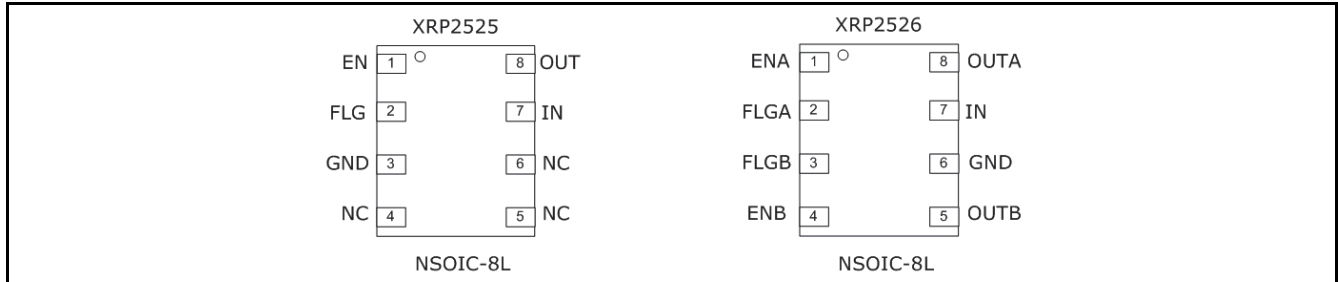

Fig. 3: XRP2525 - XRP2526 Pin Assignment

### PIN DESCRIPTION – XRP2525

| Name | Pin Number | Description   |
|------|------------|---|
| EN   | 1          | Channel Enable Input<br>Active High for XRP2525-1 and Active Low for XRP2525-2                                  |
| FLG  | 2          | Error Flag Signal<br>Active low open drain output. Active on over-current, over-temperature or UVLO conditions. |
| GND  | 3          | Ground Signal   |
| NC   | 4,5,6      | No Connect  |
| IN   | 7          | Voltage Input Pin   |
| OUT  | 8          | Voltage Output Pin  |

### PIN DESCRIPTION – XRP2526

| Name             | Pin Number | Description   |
|------------------|------------|---|
| EN <sub>x</sub>  | 1,4        | Channel Enable Input<br>Active High for XRP2526-1 and Active Low for XRP2526-2                                  |
| FLG <sub>x</sub> | 2,3        | Error Flag Signal<br>Active low open drain output. Active on over-current, over-temperature or UVLO conditions. |
| GND              | 6          | Ground Signal   |
| IN               | 7          | Voltage Input Pin   |
| OUT <sub>x</sub> | 5,8        | Voltage Output Pin  |

### ORDERING INFORMATION

| Part Number     | Temperature Range              | Marking               | Package | Packing Quantity | Note 1                     | Note 2                     |
|-----------------|--------------------------------|-----------------------|---------|------------------|----------------------------|----------------------------|
| XRP2525ID-1-F   | -40°C ≤ T <sub>A</sub> ≤ +85°C | 2525ID 1<br>YYWW<br>X | NSOIC8  | Bulk             | Lead Free and Halogen Free | Single Channel Active high |
| XRP2525IDTR-1-F |                                |                       |         | 2.5K/Tape & Reel |                            |                            |
| XRP2525ID-2-F   | -40°C ≤ T <sub>A</sub> ≤ +85°C | 2525ID 2<br>YYWW<br>X | NSOIC8  | Bulk             | Lead Free and Halogen Free | Single Channel Active low  |
| XRP2525IDTR-2-F |                                |                       |         | 2.5K/Tape & Reel |                            |                            |
| XRP2526ID-1-F   | -40°C ≤ T <sub>A</sub> ≤ +85°C | 2526ID 1<br>YYWW<br>X | NSOIC8  | Bulk             | Lead Free and Halogen Free | Dual Channel Active high   |
| XRP2526IDTR-1-F |                                |                       |         | 2.5K/Tape & Reel |                            |                            |
| XRP2526ID-2-F   | -40°C ≤ T <sub>A</sub> ≤ +85°C | 2526ID 2<br>YYWW<br>X | NSOIC8  | Bulk             | Lead Free and Halogen Free | Dual Channel Active low    |
| XRP2526IDTR-2-F |                                |                       |         | 2.5K/Tape & Reel |                            |                            |
| XRP2525EVB      | XRP2525 Evaluation Board       |                       |         |                  |                            |                            |
| XRP2526EVB      | XRP2526 Evaluation Board       |                       |         |                  |                            |                            |

“YY” = Year – “WW” = Work Week – “X” = Lot Number; when applicable.

### TYPICAL PERFORMANCE CHARACTERISTICS

All data taken at  $V_{IN} = 5V$ ,  $C_{IN} = 47\mu F // 1\mu F$ ,  $C_{OUT} = 10\mu F$ ,  $T_J = T_A = 25^\circ C$ , unless otherwise specified - Schematic and BOM from Application Information section of this datasheet.

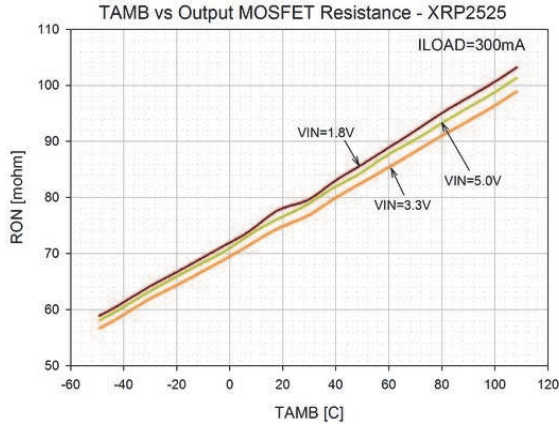

Fig. 4: Output On-Resistance vs. Temperature (XRP2525)

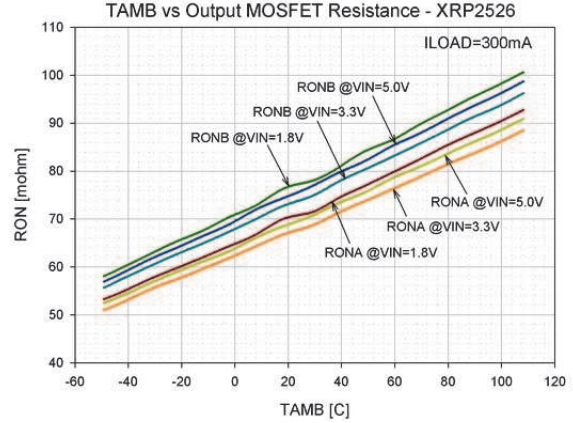

Fig. 5: Output On-Resistance vs. Temperature (XRP2526)

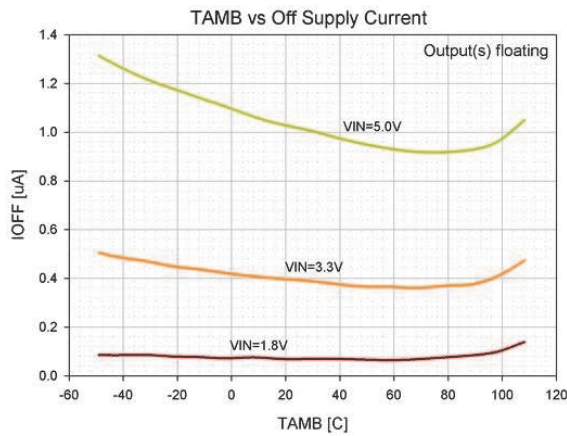

Fig. 6: Off Supply Current vs. Temperature

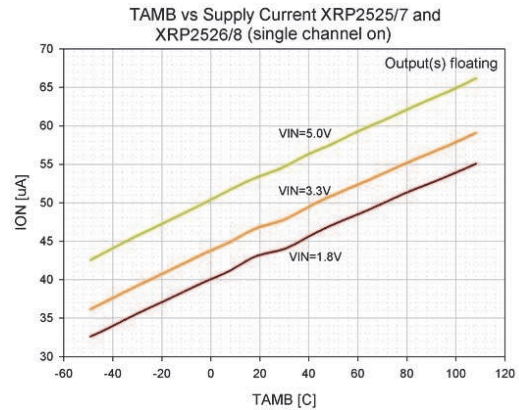

Fig. 7: Quiescent Current vs. Temperature XRP2525 and XRP2526 (1-channel on)

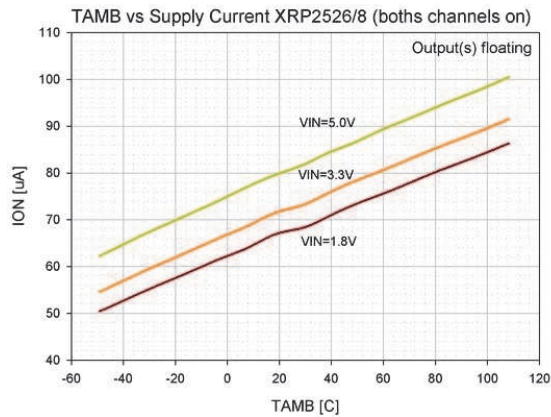

Fig. 8: Quiescent Current vs. Temperature XRP2526 (2-channels on)

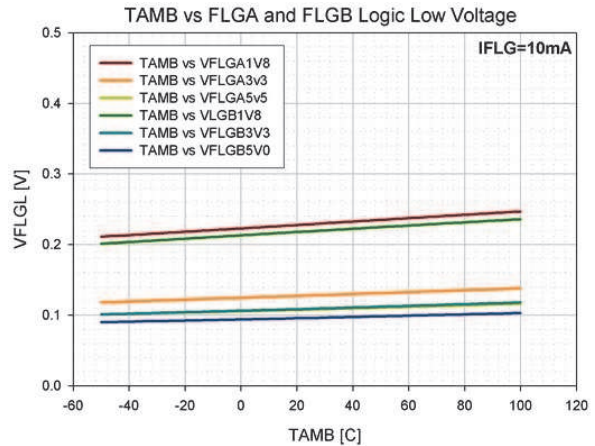

Fig. 9: FLG Logic Low Voltage vs. Temperature

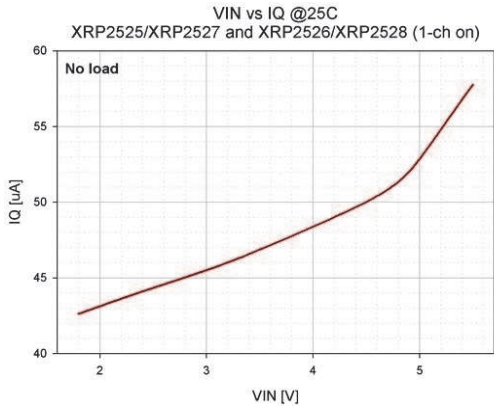

Fig. 10: Quiescent Current vs. Input Voltage XRP2525 and XRP2526 (1-channel on)

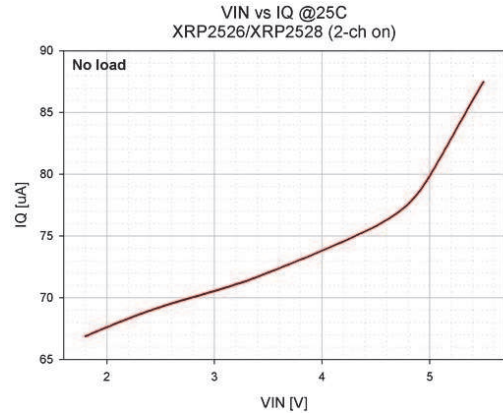

Fig. 11: Quiescent Current vs. Input Voltage XRP2526 (2-channels on)

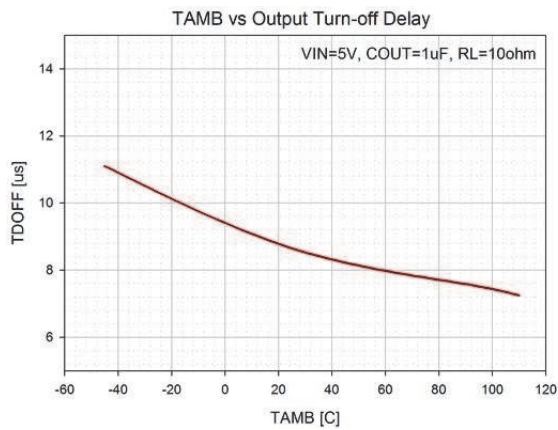

Fig. 12: Output Turn-Off Delay vs. Temperature

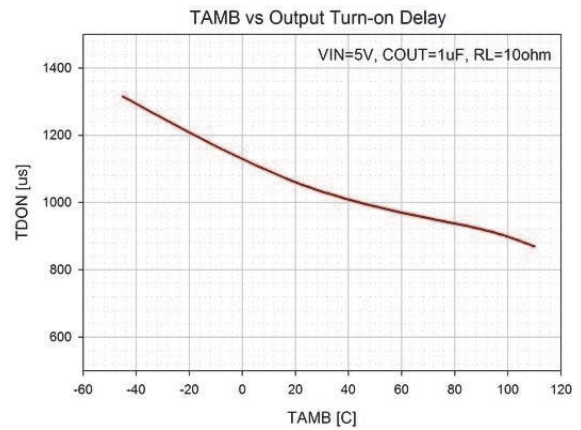

Fig. 13: Output Turn-on Delay vs. Temperature

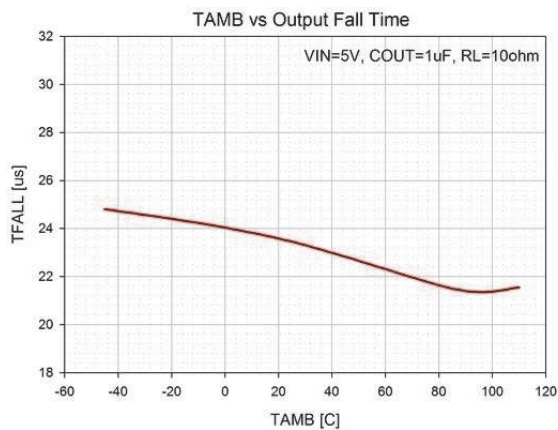

Fig. 14: Output Fall Time vs. Temperature

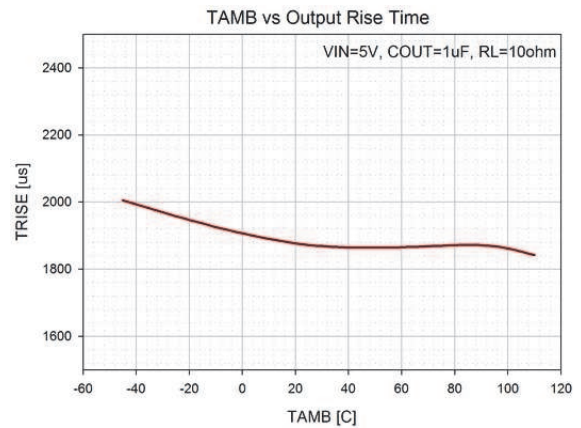

Fig. 15: Output Rise Time vs. Temperature

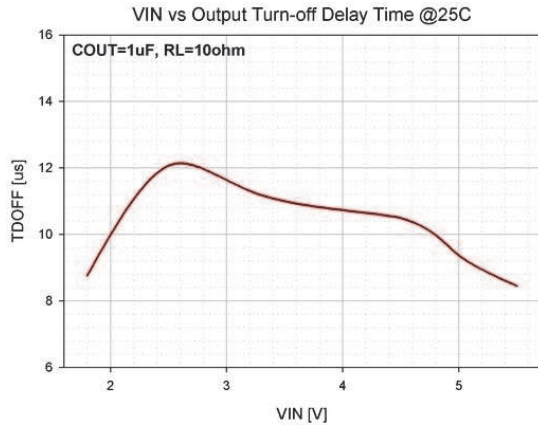

Fig. 16: Output Turn-Off Delay Time vs. Input Voltage

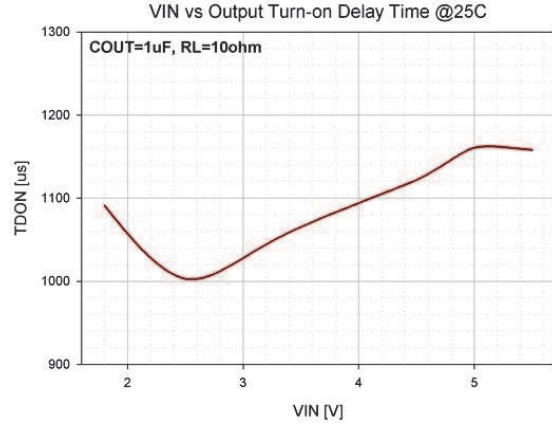

Fig. 17: Output Turn-On Delay Time vs. Input Voltage

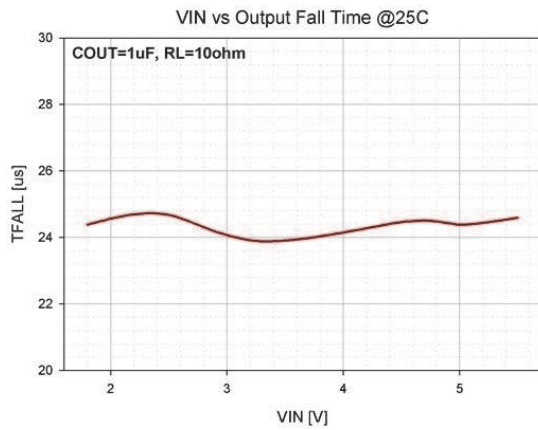

Fig. 18: Output Fall Time vs. Input Voltage

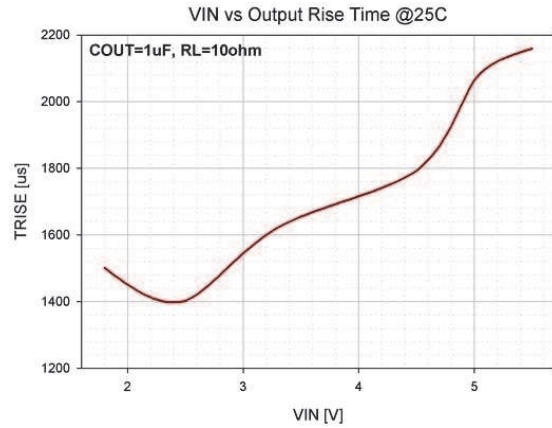

Fig. 19: Output Rise Time vs. Input Voltage

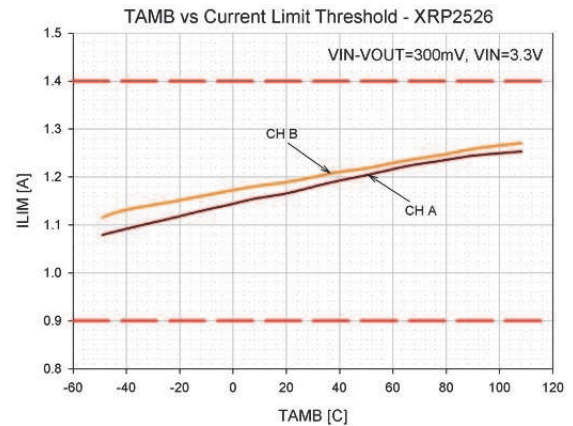
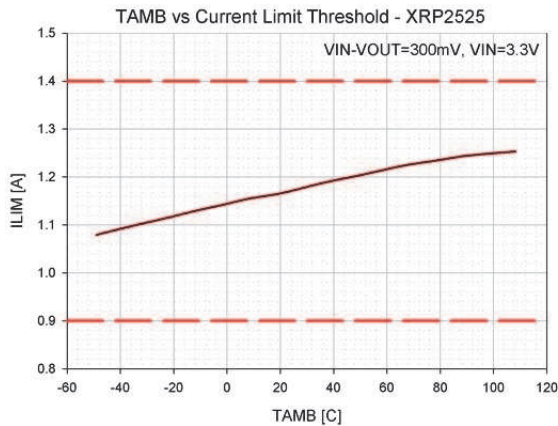

Fig. 20: Current Limit Threshold vs. Temperature (XRP2525) Fig. 21: Current Limit Threshold vs. Temperature (XRP2526)



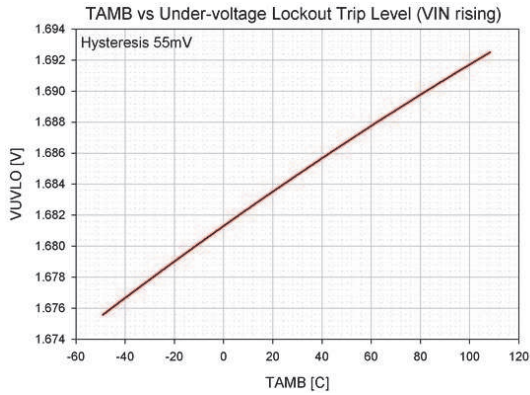

Fig. 22: Under-voltage lockout trip level vs. Temperature (VIN Rising)

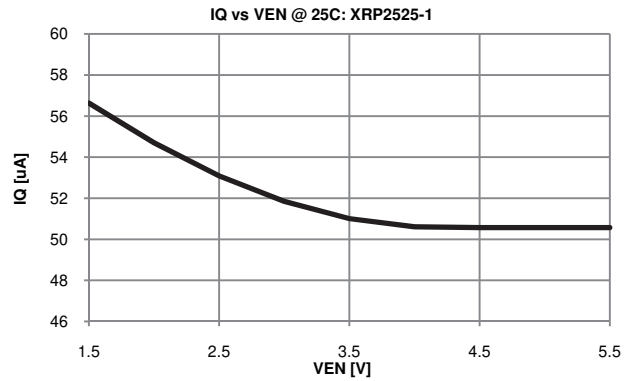

Fig. 23: Quiescent Current vs. Enable pin Voltage XRP2525-1

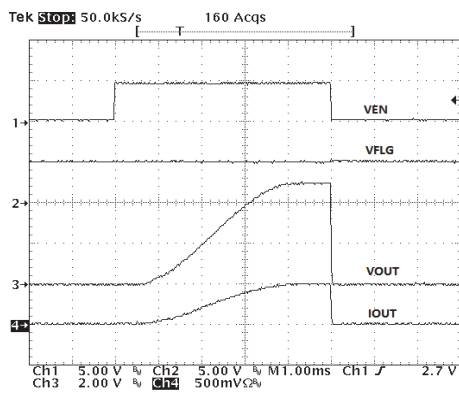

Fig. 24: Turn-On, Turn-Off Characteristics (XRP2526-1) COUT = 1uF, Load = 10Ω

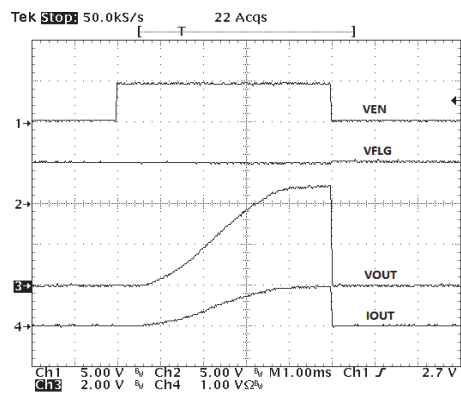

Fig. 25: Turn-On, Turn-Off Characteristics (XRP2526-1) COUT = 1uF, Load = 5.1Ω

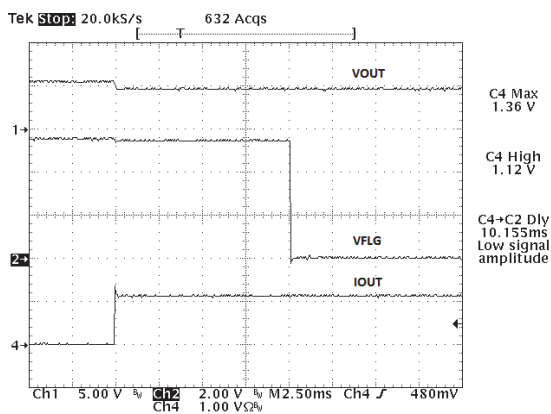

Fig. 26: Current Limit Operation (XRP2525-1): VIN=5.5V, Load = 3.9Ω

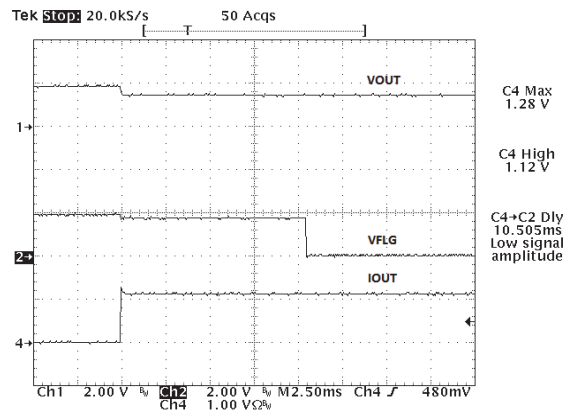

Fig. 27: Current Limit Operation (XRP2526-1): VIN=1.8V, Load = 1.5Ω

### THEORY OF OPERATION

The XRP2525 and XRP2526 devices are respectively single and dual channel integrated high-side power distribution switches that can be used in any self or bus powered USB applications. They are compliant with the latest USB 3.0 specifications. The reverse current protection feature prevents current to flow from OUT to IN when the device is disabled.

### INPUT & OUTPUT

Placing bulk capacitances of at least 47 $\mu$ F and 10 $\mu$ F at the input and output pins respectively reduces power supply transients under heavy current load conditions.

It is important to place a 1 $\mu$ F ceramic bypass capacitor from IN to GND as close as possible to the device in order to control supply transients.

Furthermore, bypassing the output pin with a 0.1 $\mu$ F to 1 $\mu$ F ceramic capacitor improves the device response to short-circuit transients.

### ERROR FLAG

The error flag signal (FLG<sub>x</sub> output pin) is an open-drain output and is pulled low (active low) upon detection of the following conditions:

- Over-current condition
- Over-temperature condition
- Under voltage lockout condition

Over-temperature and under voltage lockout conditions are flagged immediately while the over – current condition is reported only if this condition persists continuously for longer than the blanking time of 10ms. The blanking time prevents erroneous reporting of current faults due to brief output current spikes.

Once activated, the error flag signal remains low until all fault conditions have been removed and is independent for each individual channel.

### CURRENT LIMIT

The current limit threshold is preset internally. It protects the output MOSFET switches from

damages resulting from undesirable short circuit conditions or excess inrush current, which is often encountered during hot plug-in. The low limit of the current limit threshold of the XRP2525 and XRP2526 allows a minimum current of 0.9A through the MOSFET switches.

When an overcurrent condition is detected, the output current is limited to a constant current limit threshold value and output voltage is reduced accordingly. Triggering the current limit function is signaled by the Error Flag after 10ms of blanking time period.

### UNDER-VOLTAGE LOCKOUT

Under-voltage lockout function (UVLO) keeps the internal power switch from being turned on until the power supply has reached at least 1.68V, even if the switch is enabled. Upon detection of an input voltage below approximately 1.68V, the power switch is turned off while a fault condition is reported by the error flag signal.

### THERMAL PROTECTION

Internal thermal sensing circuitry monitors the operating temperature of the device for each channel independently. Upon detection of a temperature in excess of 135°C, the power switch for the given channel is disabled preventing any damages to the device while a fault condition is reported by the error flag signal. A built-in 10°C hysteresis allows the device to cool down to 125°C before resuming normal operations on the faulty channel at which point the error flag signal is cleared.

### TEST CIRCUIT

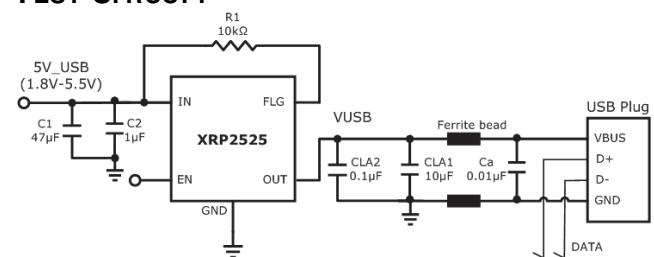



# XRP2525 - XRP2526

## Single/ Dual Channel USB 3.0 Power Distribution Switch

### PACKAGE SPECIFICATION

### 8-PIN NSOIC

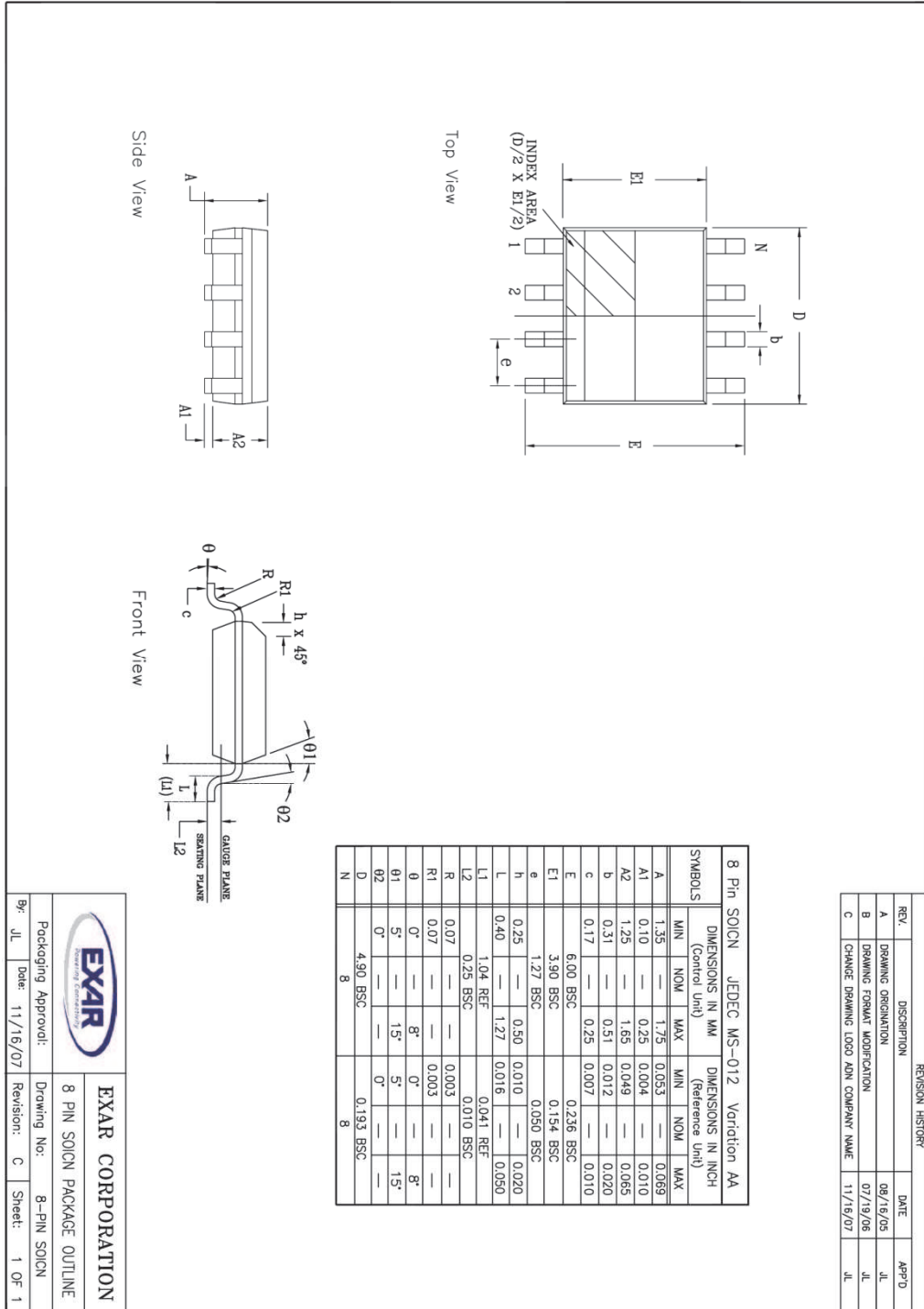



**REVISION HISTORY**

| Revision | Date       | Description                         |
|----------|------------|-------------------------------------|
| 1.0.0    | 05/13/2011 | Initial release of datasheet        |
| 1.1.0    | 07/14/2011 | Corrections of typographical errors |
|          |            |                                     |

**FOR FURTHER ASSISTANCE**

Email:

[customersupport@exar.com](mailto:customersupport@exar.com)

Exar Technical Documentation:

<http://www.exar.com/TechDoc/default.aspx?>

**EXAR CORPORATION**

**HEADQUARTERS AND SALES OFFICES**

48720 Kato Road

Fremont, CA 94538 – USA

Tel.: +1 (510) 668-7000

Fax: +1 (510) 668-7030

[www.exar.com](http://www.exar.com)



**NOTICE**

EXAR Corporation reserves the right to make changes to the products contained in this publication in order to improve design, performance or reliability. EXAR Corporation assumes no responsibility for the use of any circuits described herein, conveys no license under any patent or other right, and makes no representation that the circuits are free of patent infringement. Charts and schedules contained here in are only for illustration purposes and may vary depending upon a user's specific application. While the information in this publication has been carefully checked; no responsibility, however, is assumed for inaccuracies.

EXAR Corporation does not recommend the use of any of its products in life support applications where the failure or malfunction of the product can reasonably be expected to cause failure of the life support system or to significantly affect its safety or effectiveness. Products are not authorized for use in such applications unless EXAR Corporation receives, in writing, assurances to its satisfaction that: (a) the risk of injury or damage has been minimized; (b) the user assumes all such risks; (c) potential liability of EXAR Corporation is adequately protected under the circumstances.

Reproduction, in part or whole, without the prior written consent of EXAR Corporation is prohibited.