



Chipsmall Limited consists of a professional team with an average of over 10 year of expertise in the distribution of electronic components. Based in Hongkong, we have already established firm and mutual-benefit business relationships with customers from,Europe,America and south Asia,supplying obsolete and hard-to-find components to meet their specific needs.

With the principle of "Quality Parts,Customers Priority,Honest Operation,and Considerate Service",our business mainly focus on the distribution of electronic components. Line cards we deal with include Microchip,ALPS,ROHM,Xilinx,Pulse,ON,Everlight and Freescale. Main products comprise IC,Modules,Potentiometer,IC Socket,Relay,Connector.Our parts cover such applications as commercial,industrial, and automotives areas.

We are looking forward to setting up business relationship with you and hope to provide you with the best service and solution. Let us make a better world for our industry!



Contact us

Tel: +86-755-8981 8866 Fax: +86-755-8427 6832

Email & Skype: info@chipsmall.com Web: www.chipsmall.com

Address: A1208, Overseas Decoration Building, #122 Zhenhua RD., Futian, Shenzhen, China



GENERAL DESCRIPTION

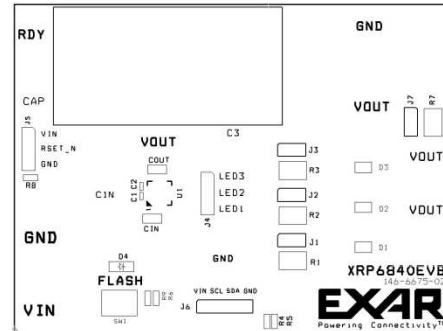
The XRP6840 is a controlled-current dual-cell supercapacitor charger and high power LED driver. Operating from a standard lithium-ion battery, the XRP6840 provides up to 4.3A of programmable Flash LED current and up to 600mA and 5.6V of programmable supercapacitor charging current and voltage.

The XRP6840EVB, Exar’s XRP6840 Evaluation Board, supports either XRP6840A or XRP6840B in a 4x4 TQFN package and is fitted by default with the XRP6840A supporting three channels.

With 1x, 1.5x and 2x charge pump operating modes, XRP6840EVB can provide a stable drive current for up to 3 1.5A, 4W Luxeon Flash LEDs. The evaluation board is a completely assembled and tested surface mount board which provides easy probe access points to all XRP6840 inputs and outputs for easy connection and measuring.

The Evaluation Board schematic diagram is shown in Figure 1.

EVALUATION BOARD MANUAL



FEATURES

- **Programmable 4.3A Flash LED Driver**
 - Torch and Flash Modes
- **Programmable Supercapacitor Charger**
 - 600mA Adjustable Charging Current
 - Programmable Supercapacitor Voltage
 - Active Voltage Balance Control
- **Tri-mode Charge Pump Architecture**
 - 1x, 1.5x, 2x Operation Modes
 - 2.4MHz Switching Frequency
- **I²C Serial Interface**

EVALUATION BOARD SCHEMATICS

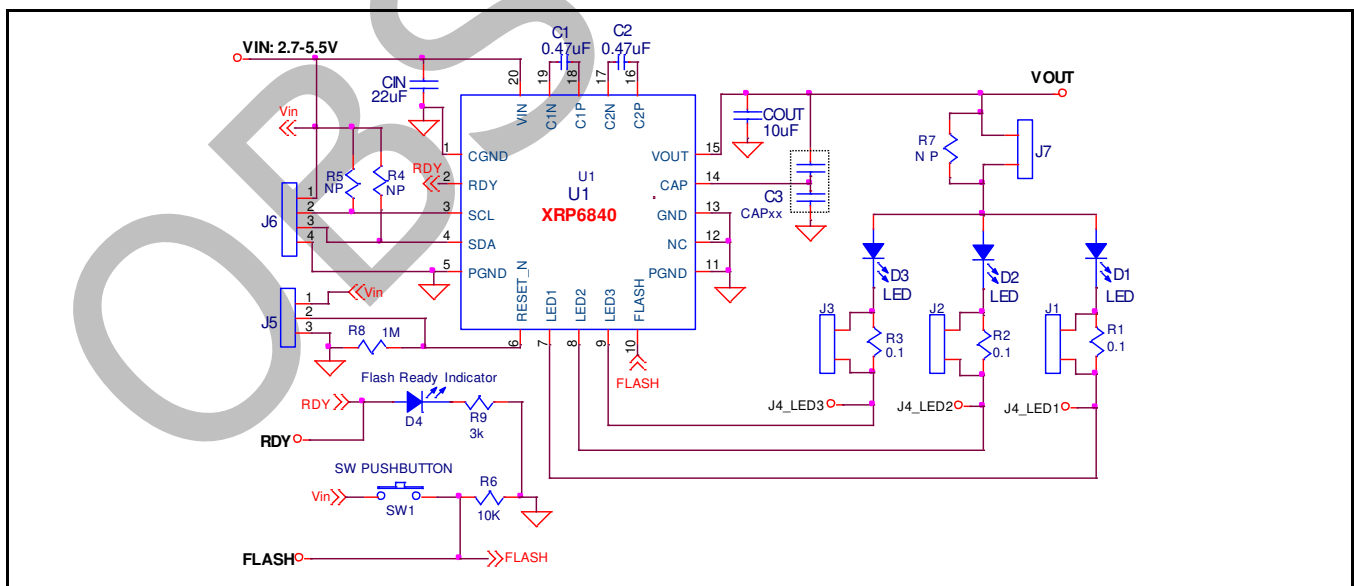


Fig. 1: XRP6840 Evaluation Board Schematics

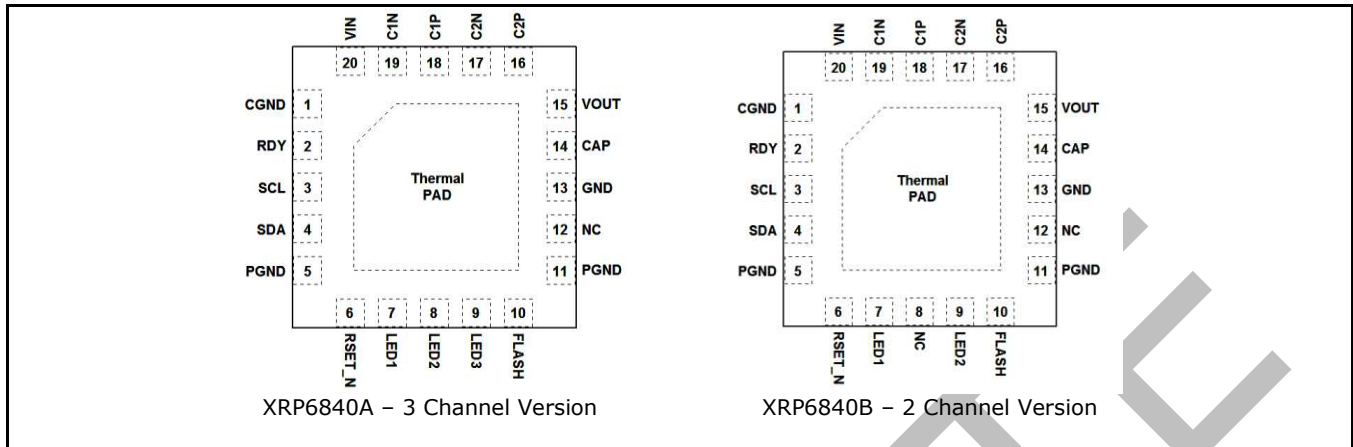
4.3A Supercapacitor Flash LED Driver with I²C
PIN ASSIGNMENT


Fig. 2: XRP6840 Pin Assignment

PIN DESCRIPTION

Name	Pin Number	Description
CGND	1	Charge pump ground pin.
RDY	2	Active high push-pull output. RDY is high when V _{OUT} reached to 100mV below its V _{OUT_LIMIT} voltage. The V _{OUT_LIMIT} for Flash mode is determined by STATUS2 register [B7 B6 B5]. The V _{OUT_LIMIT} for Torch mode is 4.50V.
SCL, SDA	3, 4	The SDA and SCL pins connect to the I ² C bus. Multiple functions can be programmed through his interface. They can also be used for read-back.
PGND	5, 11	Power ground pin. The Source of internal NMOS is connected to this pin.
RESET_N	6	Active Low input pin. If RESET_N = 0, then XRP6840 is in Shut-down mode If RESET_N = 0 and STATUS1 register [B5] = 0, then reset all registers to logic low. If RESET_N = 0 and STATUS1 register [B5] = 1, then all bits of all registers will be saved.
LED ₁ , LED ₂ , LED ₃ (XRP6840A)	7, 8, 9	LED ₁ , LED ₂ , LED ₃ connect to the drain of the internal NMOS which are current sources for LED current. These current sources are controlled by LEDFLASH or LEDTORCH registers which is programmed through I ² C to provide the Torch and Flash current for the LEDs. LED ₁ , LED ₂ , LED ₃ pins can be connected together to provide higher LED current.
LED ₁ , NC, LED ₂ (XRP6840B)	7, 8, 9	If a pin is not used connect it to V _{OUT} . The XRP6840 incorporates a short LED protection circuit which shut-down LED current if LED voltage approaches to V _{OUT_LIMIT} .
FLASH	10	Digital Input pin. Active high. If STATUS1 register [B7 B6] = 11 and FLASH = 1 then LEDs are ON for one Flash timeout duration. Flash Timeout duration is controlled by STATUS1 register [B1 B0].
NC	12	No connection. This pin can be connected to PGND pin for heat sink.
GND	13	Ground pin. This ground pin doesn't carry high internal current.
CAP	14	This pin is the output of an internal Op-Amp. This internal Op-Amp is powered by V _{OUT} . The output voltage is half of V _{OUT} , and output resistance is 470Ω. The sink and source current is limited by 470Ω output resistance. This provides active balancing between two internal sections of the super capacitor.
V _{OUT}	15	Output voltage. Connect positive terminal of SuperCap here. Connect the LEDs between this pin and the corresponding internal current source. Decouple with 10μF ceramic capacitor close to the pins of the IC.
C _{2P} , C _{2N}	16, 17	Connect C ₂ external flying capacitor between these pins.
C _{1P} , C _{2P}	18, 19	Connect C ₁ external flying capacitor between these pins.
V _{IN}	20	Power supply input. Decouple with 10μF ceramic capacitor close to the pins of the IC.
Thermal Pad	-	Connect thermal pad to PGND pins.

4.3A Supercapacitor Flash LED Driver with I²C

USING THE EVALUATION BOARD

POWERING UP THE XRP6840 CIRCUIT

The XRP6840 Evaluation Board can be powered from a 5V power supply. Connect with short leads directly to the "VIN" and "GND" posts. To power up XRP6840A/B connect the "RESET_N" Jumper to the "VIN" position and connect J7 or place Resistor R7 of 0Ω. The I²C can be programmed through SCL, SDA jumper J6.

GETTING STARTED ON XRP6840EVB

1. Connect VIN and GND to a power supply (VIN range is 2.7V~5.5V).
2. Connect RESET_N to VIN on Jumper J5.
3. Connect Jumper J7 to drive LEDs.
4. Connect I²C Interface pins: SDA, SCL, GND
5. Program Torch or Flash Mode and the desired operating current through I²C.
6. For Flash Mode, the push button can be used to power LEDs after each Flash Duration Timeout.

The I²C Interface and the available Registers are described in the subsequent sections.

I²C SERIAL INTERFACE

REGISTERS

The XRP6840 has five serially programmable data registers via the I²C interface. These registers can be reset to '0' through power on reset or setting RESET_N, pin 6, to '0'. The first register is for Device Address as shown in Figure 3; it is activated by '28' HEX (7-bit format). The second register, STATUS1, contains the control word for programming operating modes, shutdown control, charge pump modes and flash timeout. The third register, STATUS2, contains the flash voltage level, read back of the Flash Ready, and fault conditions UVLO and over temperature. The fourth register, LEDFLASH, controls individual LED channels and current level in Flash Mode. The fifth register, LEDTORCH, controls individual LED channels and current level in Torch Mode.

Register	B7	B6	B5	B4	B3	B2	B1	B0
----------	----	----	----	----	----	----	----	----

Address	0	1	0	1	0	0	0	R/W
STATUS1	Flash Torch Mode	Flash Torch Mode	Shut Down Control	Gain	Gain	-	Flash Timeout	Flash Timeout
STATUS2	Flash V	Flash V	Flash V	Flash Ready	UVLO Fault	Temp Fault	0	0
LEDFLASH	LED1	LED2	LED3*	D3	D1	D0	-	-
LEDTORCH	LED1	LED2	LED3*	D3	D2	D1	D0	-

Table 1: XRP6840 I²C Registers Bit Map

* Not used for XRP6840B

STATUS1 Register

STATUS1 Register Bits B7, B6, B4 and B3

B7	B6	B4	B3	Operation Mode
0	1	0	0	High Efficiency Torch Mode
0	1	0	1	1X Torch Mode
0	1	1	0	1.5X Torch Mode
0	1	1	1	2X Torch Mode
1	0	0	0	Auto Gain Torch Mode
1	0	0	1	1X Torch Mode
1	0	1	0	1.5X Torch Mode
1	0	1	1	2X Torch Mode
1	1	0	0	Auto Gain Flash Mode
1	1	0	1	1X Flash Mode
1	1	1	0	1.5X Flash Mode
1	1	1	1	2X Flash Mode

Table 2: STATUS1 Register Operation Modes

STATUS1 Register Bit B5

This bit is used to save or reset the contents of STATUS1, STATUS2, LEDFLASH and LEDTORCH registers for the next I²C command when RESET_N, pin 6, is '1'. If B5 is '1' then all bits in these registers will be saved. Otherwise if B5 is '0' then all bits will be reset to '0'.

STATUS1 Register Bits B1 and B0

These two bits program the flash timeout duration as follows:

B1	B0	Flash Duration
0	0	0.11s
0	1	0.22s
1	0	0.53s
1	1	1.10s

Table 3: Charge Pump Mode Selection

STATUS2 Register

Flash Mode Voltage Programming

V_{OUT_LIMIT} in Flash Mode is regulated with 50mV of hysteresis and is programmed through bits B7, B6 and B5 of STATUS2 register as follows:

4.3A Supercapacitor Flash LED Driver with I²C

B7	B6	B5	Comment
0	0	0	4.55V
0	0	1	4.70V
0	1	0	4.85V
0	1	1	5.00V
1	0	0	5.15V
1	0	1	5.30V
1	1	0	5.45V
1	1	1	5.60V

Table 4: Flash Mode V_{OUT_LIMIT} Settings

Bit B4

RDY bit is available for I²C read-back. This bit is set to '1' when V_{OUT} > V_{OUT_LIMIT}, and set to '0' otherwise.

Fault mode read-back bits B3, B2

These bits are designed for 2 Fault Mode flags and are also available for I²C read-back. Bits 3 and 2 are set to '1' when UVLO and over temperature conditions are detected, as shown in Table 1.

LEDFLASH Register

LEDFLASH register, bits B7, B6 and B5 are used to activate the LED outputs channels as summarized in Table 1; they correspond to LED₁, LED₂ and LED₃. Bits B4, B3 and B2 represent the DAC codes D2, D1, D0. They are used to set the flash LED current levels in each channel. Table 5 provides the DAC codes and the corresponding nominal current levels for each channel:

D2-D0 Code	XRP6840A I _{OUT/Ch.} (mA)	D2-D0 Code	XRP6840B I _{OUT/Ch.} (mA)
0 0 0	0	0 0 0	0
0 0 1	400	0 0 1	597
0 1 0	586	0 1 0	875
0 1 1	770	0 1 1	1127
1 0 0	948	1 0 0	1400
1 0 1	1197	1 0 1	1671
1 1 0	1291	1 1 0	1910
1 1 1	1445	1 1 1	2150

Table 5: Nominal Flash Mode Output Current

LEDTORCH Register

LEDTORCH register bits B2 to B7, also summarized in Table 1; they correspond to LED₁, LED₂ and LED₃. Bits B4, B3, B2, and B1 represent the DAC codes D3, D2, D1, D0. They

TYPICAL PERFORMANCE CHARACTERISTICS

All data taken at V_{IN} = 2.7V-5.5V, unless otherwise specified.

are used to set the torch LED current levels in each channel. Table 6 provides the DAC codes and their corresponding nominal current levels for each channel. Remember that the total current that can be supported in torch mode is 600mA divided by the gain of the charge pump. If 2 channels are set to 440mA (a total of 880mA), even with a gain of 1X, the input current limit will clamp the total current to approximately 600mA.

D3-D0 Code	XRP6840A I _{OUT/Ch.} (mA)	D3-D0 Code	XRP6840B I _{OUT/Ch.} (mA)
0 0 0 0	0	0 0 0 0	0
0 0 0 1	23	0 0 0 1	34
0 0 1 0	46	0 0 1 0	66
0 0 1 1	66	0 0 1 1	97
0 1 0 0	86	0 1 0 0	127
0 1 0 1	105	0 1 0 1	155
0 1 1 0	125	0 1 1 0	185
0 1 1 1	145	0 1 1 1	215
1 0 0 0	165	1 0 0 0	245
1 0 0 1	185	1 0 0 1	275
1 0 1 0	205	1 0 1 0	305
1 0 1 1	225	1 0 1 1	330
1 1 0 0	245	1 1 0 0	360
1 1 0 1	260	1 1 0 1	385
1 1 1 0	280	1 1 1 0	415
1 1 1 1	300	1 1 1 1	440

Table 6: Torch Mode Output Current

Addressing and Writing Data

To write data to the XRP6840 one of the following two sequences is required:

Easy shutdown/startup sequence

[Slave Address with write bit][Data for Status]

Full shutdown/startup sequence

[Slave Address with write bit][Data for Status]
[Data for LEDFLASH][Data for LEDTORCH]

Slave address is '28' Hex.

Addressing and Reading Data

To read data from the XRP6840 the following sequence is required:

[Slave Address with read bit][Data for Status]
[Data for LEDFLASH][Data for LEDTORCH]

4.3A Supercapacitor Flash LED Driver with I²C

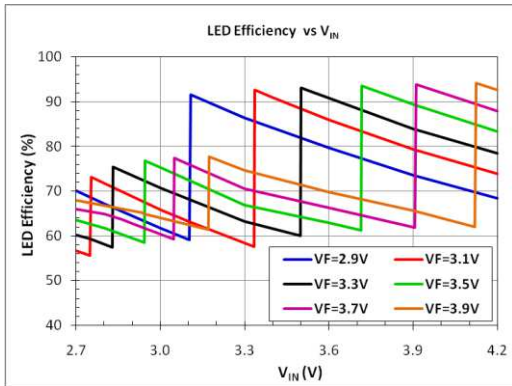


Fig. 3: High Efficiency Torch Mode I_{LED} at 200mA with PWF4W-001

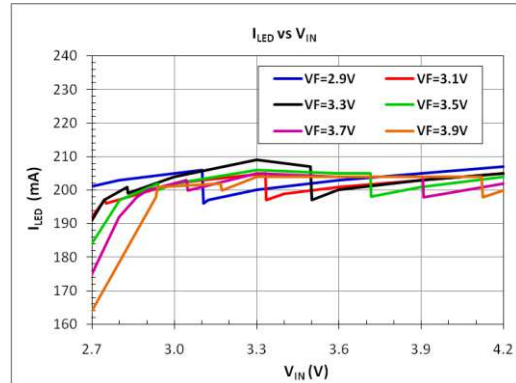


Fig. 4: High Efficiency Torch Mode, LED Current versus V_{IN}

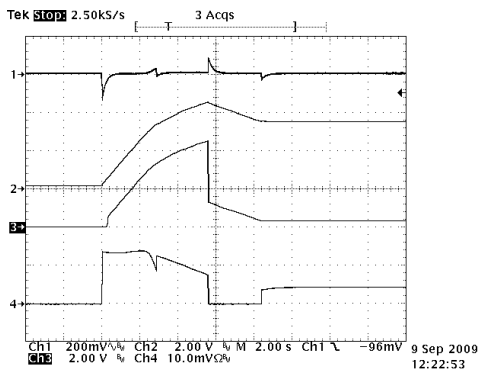


Fig. 5: 200mA High Efficiency Torch Mode with 0.55F Supercap, CH1= V_{IN} , CH2= V_{OUT} , CH3= LED_x , CH4= $I_{VIN} = 0.5A/div$

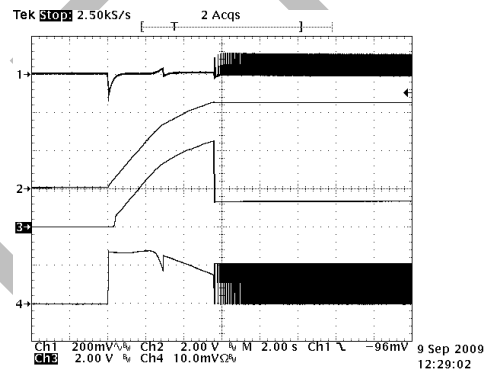


Fig. 6: 200mA Torch Mode with 0.55F Supercap, CH1= V_{IN} , CH2= V_{OUT} , CH3= LED_x , CH4= $I_{VIN} = 0.5A/div$

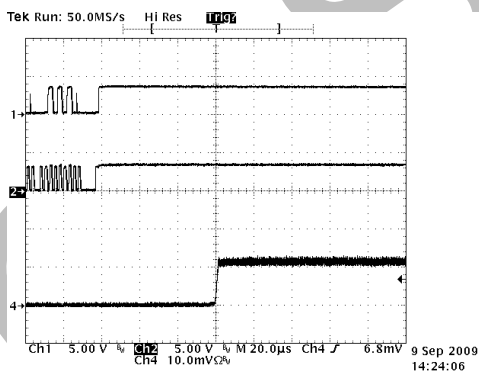


Fig. 7: LED Current Settling Time: 0mA to 100mA. CH1=SDA, CH2=SCL, CH4= $I_{LED} = 0.1A/div$

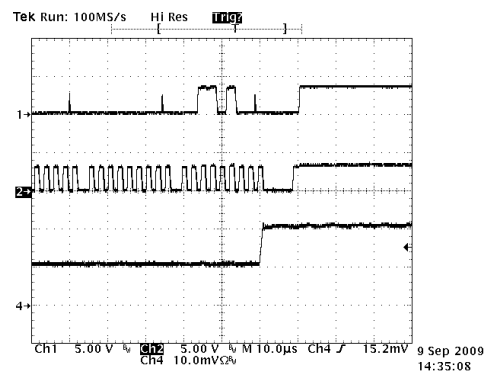


Fig. 8: LED Current Settling Time: 100mA to 200mA. CH1=SDA, CH2=SCL, CH4= $I_{LED} = 0.1A/div$

4.3A Supercapacitor Flash LED Driver with I²C

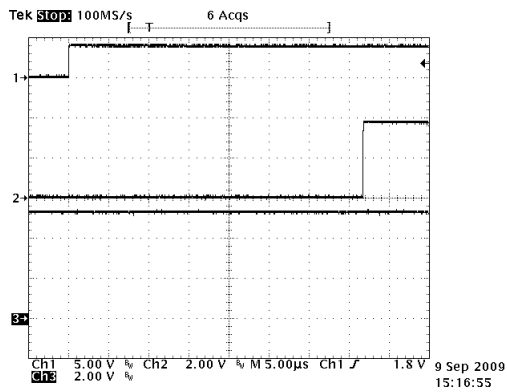


Fig. 9: Figure 21: Flash Mode Enable From Shutdown
CH1=RESET_N, CH2=RDY, CH3=V_{OUT}

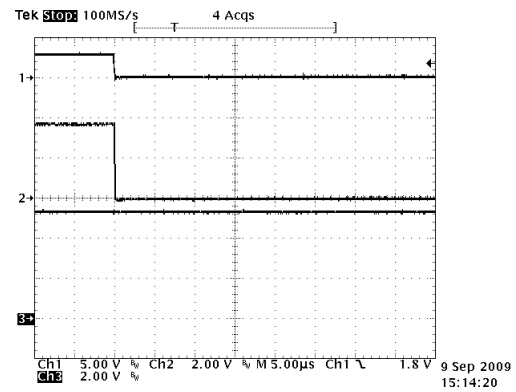


Fig. 10: Flash Mode Shutdown. CH1=RESET_N,
CH2=RDY, CH3=V_{OUT}

OBSOLETE

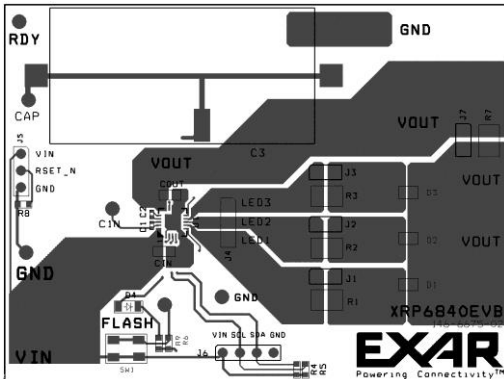
EVALUATION BOARD LAYOUT


Fig. 11: XRP6840 Evaluation Board Component Placement and Component Side Lay Out

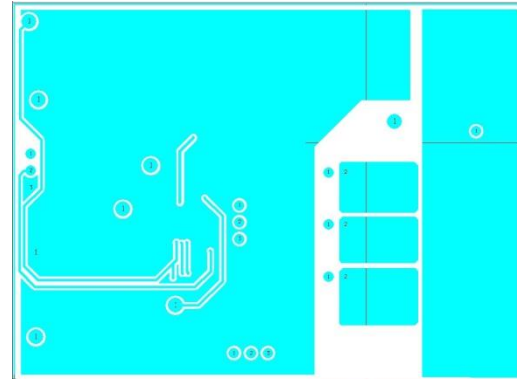


Fig. 12: XRP6840 Evaluation Board Soldier Side Lay Out

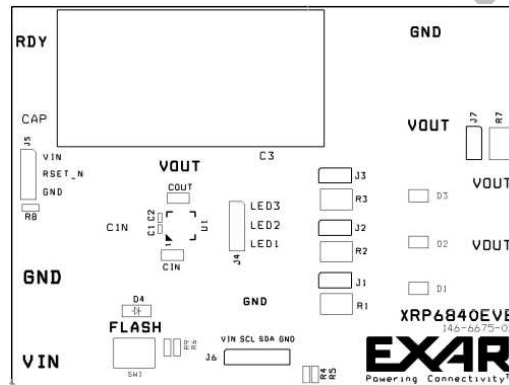


Fig. 13: XRP6840 Evaluation Board Component Placement

BILL OF MATERIAL

Ref.	Qty	Manufacturer	Part Number	Size	Component
EVAL BD	1	Exar Corp	146-6675-02	2.25"x3.0"	XRP6840EVB Evaluation Board
U1	1	Exar Corp	XRP6840A1LB-F	TQFN-20L	4.8A Supercapacitor Flash LED Driver with I ² C
CIN	1	Murata	GRM219R61A226KE44B	0805	Ceramic 22µF 10V X5R
COUT	1	Murata	GRM219R61A106KE44B	0805	Ceramic 10µF 10V X5R
C1, C2	2	Murata	GRM155B31A474KE14B	0402	Ceramic 0.47µF 10V X5R
C3	1	Cap-xx	HS106	29x17x2.4mm	Super Capacitor 0.6F/5.5V 70mΩ ESR, 20%
D1, D2, D3	3	Lumileds	LXCL-PWF4W-0001	2.04x1.64x0.75mm	1.5A Luxeon Flash LED
D4	1	Vishay	TLMG2100-GS08	2.3x1.3x1.4mm	Green Color Mini LED
J1, J2, J3, J7	4	Würth Electronics	61303611121	0.64mm SQ x 6mm	2 Pin Header, 2.54mm pitch
J4, J5	2	Würth Electronics	61303611121	0.64mm SQ x 6mm	3 Pin Header, 2.54mm pitch
J6	1	Würth Electronics	61304011021	0.64mm SQ x 6mm	4 Pin Angled Header, 2.54mm pitch
R1, R2, R3	3	Vishay	CRCW0805R100F	0805	0.1Ω Resistor, 0.25W, 1%
R4, R5, R7	3	NP	NP	NP	NP
R6	1	Vishay	CRCW060310K00F	0603	10KΩ Resistor, 0.1W, 1%
R8	1	Vishay	CRCW06031M00J	0603	1MΩ Resistor, 0.1W, 5%
R9	1	Vishay	CRCW06033K01J	0603	3.01KΩ Resistor, 0.1W, 1%
SW1	1	Bourn Inc.	7914J-1-000	4.8x5.0 mm	Push Button Switch
Test Point VIN, VOUT, GND, RDY, CAP, CIN, FLASH	12	Mill-Max	0300-115-01-4727100	0.042" diameter	Test Point Female Pin



REVISION HISTORY

Revision	Date	Description
1.0.0	12/07/09	Initial release of document
	09/08/14	OBSOLETE - See "XRP6840EVB Exarizer"

FOR FURTHER ASSISTANCE

Email:

customersupport@exar.com

Exar Technical Documentation:

<http://www.exar.com/TechDoc/default.aspx?>



EXAR CORPORATION

HEADQUARTERS AND SALES OFFICES

48720 Kato Road

Fremont, CA 94538 – USA

Tel.: +1 (510) 668-7000

Fax: +1 (510) 668-7030

www.exar.com

NOTICE

EXAR Corporation reserves the right to make changes to the products contained in this publication in order to improve design, performance or reliability. EXAR Corporation assumes no responsibility for the use of any circuits described herein, conveys no license under any patent or other right, and makes no representation that the circuits are free of patent infringement. Charts and schedules contained here in are only for illustration purposes and may vary depending upon a user's specific application. While the information in this publication has been carefully checked; no responsibility, however, is assumed for inaccuracies.

EXAR Corporation does not recommend the use of any of its products in life support applications where the failure or malfunction of the product can reasonably be expected to cause failure of the life support system or to significantly affect its safety or effectiveness. Products are not authorized for use in such applications unless EXAR Corporation receives, in writing, assurances to its satisfaction that: (a) the risk of injury or damage has been minimized; (b) the user assumes all such risks; (c) potential liability of EXAR Corporation is adequately protected under the circumstances.

Reproduction, in part or whole, without the prior written consent of EXAR Corporation is prohibited.