



Chipsmall Limited consists of a professional team with an average of over 10 year of expertise in the distribution of electronic components. Based in Hongkong, we have already established firm and mutual-benefit business relationships with customers from,Europe,America and south Asia,supplying obsolete and hard-to-find components to meet their specific needs.

With the principle of “Quality Parts,Customers Priority,Honest Operation,and Considerate Service”,our business mainly focus on the distribution of electronic components. Line cards we deal with include Microchip,ALPS,ROHM,Xilinx,Pulse,ON,Everlight and Freescale. Main products comprise IC,Modules,Potentiometer,IC Socket,Relay,Connector.Our parts cover such applications as commercial,industrial, and automotives areas.

We are looking forward to setting up business relationship with you and hope to provide you with the best service and solution. Let us make a better world for our industry!



Contact us

Tel: +86-755-8981 8866 Fax: +86-755-8427 6832

Email & Skype: info@chipsmall.com Web: www.chipsmall.com

Address: A1208, Overseas Decoration Building, #122 Zhenhua RD., Futian, Shenzhen, China



Features

- Housing material: Type 66 Nylon
- Black casing provides superior contrast
- Housing UL rating: 94V-0
- Reliable & robust
- RoHS Compliant



Package Schematics

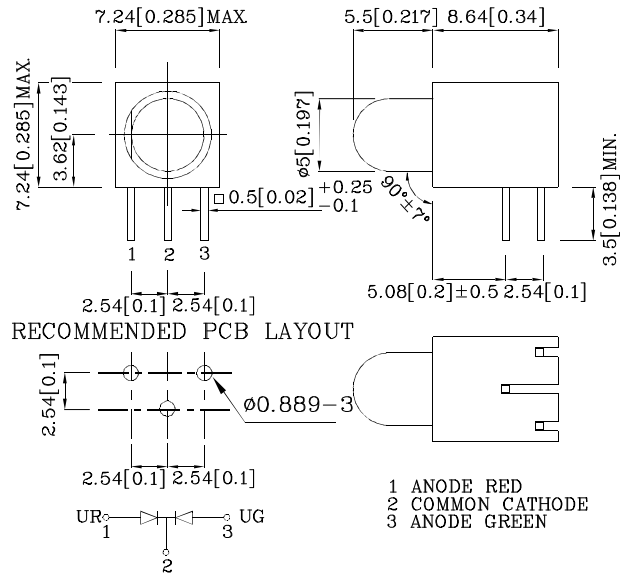

Notes:

1. All dimensions are in millimeters (inches).
2. Tolerance is ±0.25(0.01") unless otherwise noted.
3. Specifications are subject to change without notice.

| Absolute Maximum Ratings (T _A =25°C) | | UR (GaAsP/ GaP) | UG (GaP) | Unit |
|--|---------------------|-----------------------|-------------|------|
| Reverse Voltage | V _R | 5 | 5 | V |
| Forward Current | I _F | 30 | 25 | mA |
| Forward Current (Peak) 1/10 Duty Cycle 0.1ms Pulse Width | i _{FS} | 160 | 140 | mA |
| Power Dissipation | P _D | 75 | 62.5 | mW |
| Operating Temperature | T _A | -40 ~ +85 | | °C |
| Storage Temperature | T _{stg} | -40 ~ +85 | | |
| Lead Solder Temperature [2mm Below Package Base] | 260°C For 3 Seconds | | | |
| Lead Solder Temperature [5mm Below Package Base] | 260°C For 5 Seconds | | | |

| Operating Characteristics (T _A =25°C) | | UR (GaAsP/ GaP) | UG (GaP) | Unit |
|--|----------------|-----------------------|-------------|------|
| Forward Voltage (Typ.) (I _F =20mA) | V _F | 2 | 2.2 | V |
| Forward Voltage (Max.) (I _F =20mA) | V _F | 2.5 | 2.5 | V |
| Reverse Current (Max.) (V _R =5V) | I _R | 10 | 10 | uA |
| Wavelength of Peak Emission CIE127-2007* (Typ.) (I _F =20mA) | λ _P | 627* | 565* | nm |
| Wavelength of Dominant Emission CIE127-2007* (Typ.) (I _F =20mA) | λ _D | 617* | 568* | nm |
| Spectral Line Full Width At Half-Maximum (Typ.) (I _F =20mA) | Δλ | 45 | 30 | nm |
| Capacitance (Typ.) (V _F =0V, f=1MHz) | C | 15 | 15 | pF |

| Part Number | Emitting Color | Emitting Material | Lens-color | Luminous Intensity CIE127-2007* (I _F =20mA) mcd | | Wavelength CIE127-2007* nm λ _P | Viewing Angle 2θ 1/2 |
|-------------|----------------|-------------------|----------------|---|-----------|--|-------------------------|
| | | | | min. | typ. | | |
| XVM1LUGR59M | Red | GaAsP/GaP | White Diffused | 30 20* | 59 39* | 627* | 60° |
| | Green | GaP | | 20 20* | 59 59* | | |

*Luminous intensity value and wavelength are in accordance with CIE127-2007 standards.

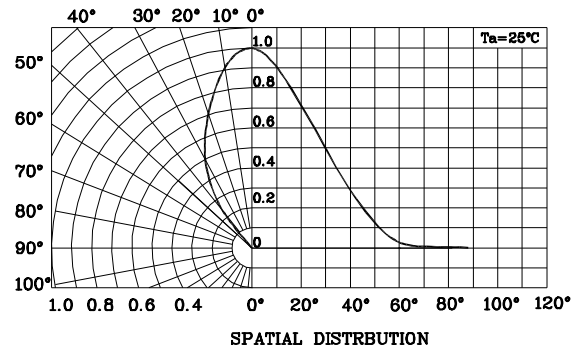
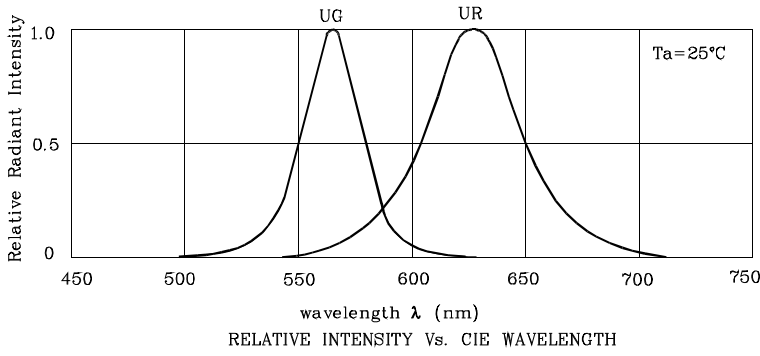

❖ UR

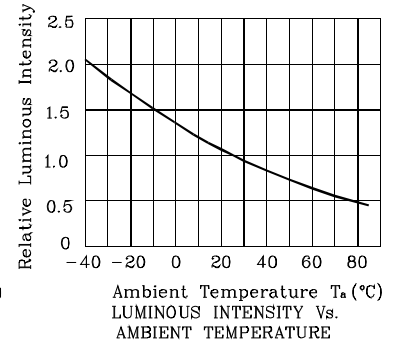
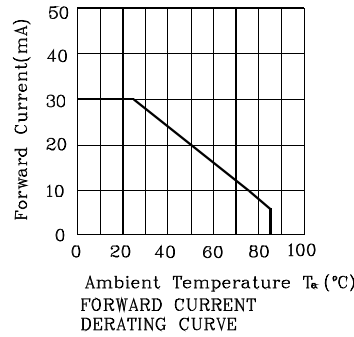
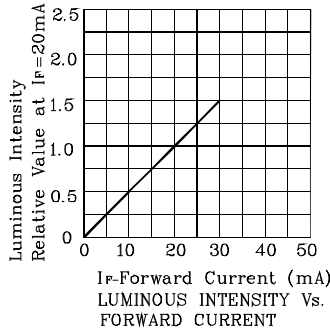
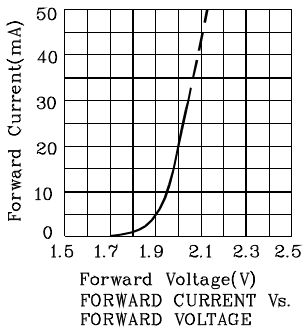

❖ UG

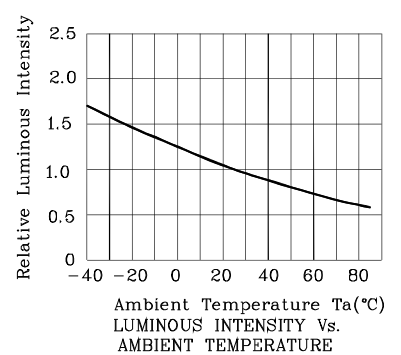
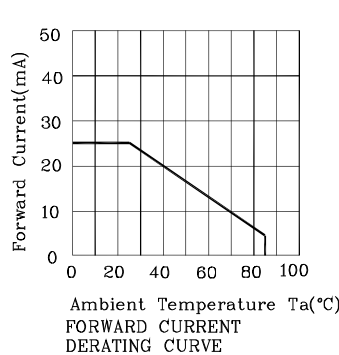
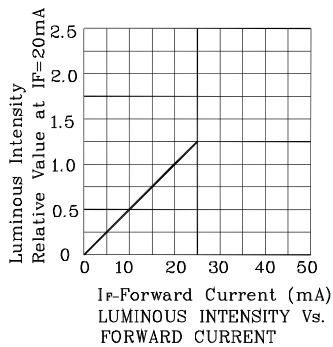
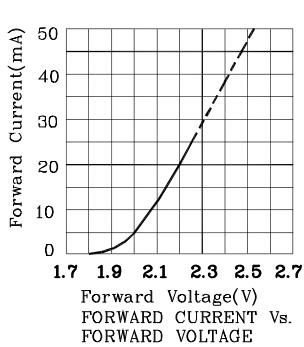

Wave Soldering Profile For Thru-Hole Products (Pb-Free Components)

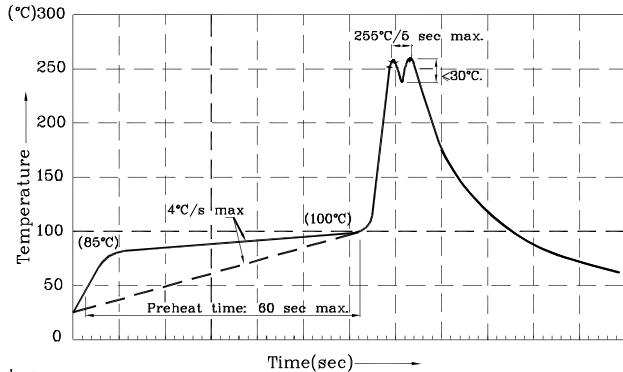

- Notes:
- 1.Recommend pre-heat temperature of 105°C or less (as measured with a thermocouple attached to the LED pins) prior to immersion in the solder wave with a maximum solder bath temperature of 260°C
 - 2.Peak wave soldering temperature between 245°C ~ 255°C for 3 sec (5 sec max).
 - 3.Do not apply stress to the epoxy resin while the temperature is above 85°C.
 - 4.Fixtures should not incur stress on the component when mounting and during soldering process.
 - 5.SAC 305 solder alloy is recommended.
 - 6.No more than one wave soldering pass.



Remarks:

If special sorting is required (e.g. binning based on forward voltage, luminous intensity / luminous flux, or wavelength), the typical accuracy of the sorting process is as follows:

1. Wavelength: +/-1nm
 2. Luminous Intensity / Luminous Flux: +/-15%
 3. Forward Voltage: +/-0.1V
- Note: Accuracy may depend on the sorting parameters.

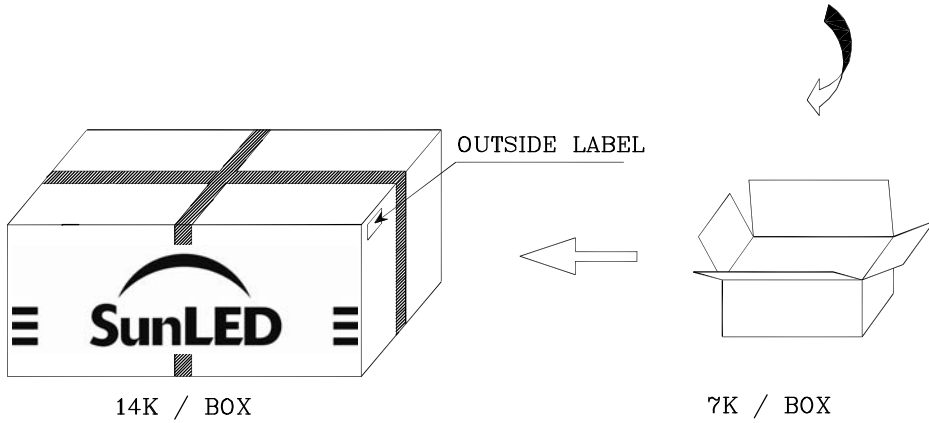
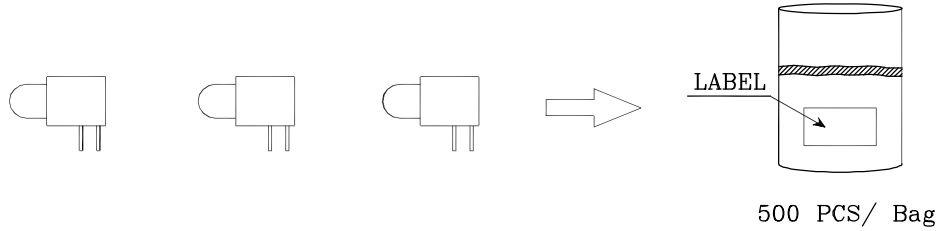
PACKING & LABEL SPECIFICATIONS



| | | | | | | |
|--|--|--|------|-----|----------|--------|
|  | | <table border="1"> <tr><td>Q.C.</td></tr> <tr><td>Q C</td></tr> <tr><td>XX XX XX</td></tr> <tr><td>PASSED</td></tr> </table> | Q.C. | Q C | XX XX XX | PASSED |
| Q.C. | | | | | | |
| Q C | | | | | | |
| XX XX XX | | | | | | |
| PASSED | | | | | | |
| P/NO : XVM1Lxx59x | | | | | | |
| QTY : 500 pcs | | CODE: XXX | | | | |
| S/N : XX | | | | | | |
| LOT NO: | | | | | | |
|  XXXXXXXXXXXXXXXXXXXX | | | | | | |
| RoHS Compliant | | | | | | |

TERMS OF USE

1. Data presented in this document reflect statistical figures and should be treated as technical reference only.
2. Contents within this document are subject to improvement and enhancement changes without notice.
3. The product(s) in this document are designed to be operated within the electrical and environmental specifications indicated on the datasheet.
User accepts full risk and responsibility when operating the product(s) beyond their intended specifications.
4. The product(s) described in this document are intended for electronic applications in which a person's life is not reliant upon the LED. Please consult with a SunLED representative for special applications where the LED may have a direct impact on a person's life.
5. The contents within this document may not be altered without prior consent by SunLED.
6. Additional technical notes are available at <http://www.SunLEDusa.com/TechnicalNotes.asp>