



Chipsmall Limited consists of a professional team with an average of over 10 year of expertise in the distribution of electronic components. Based in Hongkong, we have already established firm and mutual-benefit business relationships with customers from,Europe,America and south Asia,supplying obsolete and hard-to-find components to meet their specific needs.

With the principle of “Quality Parts,Customers Priority,Honest Operation,and Considerate Service”,our business mainly focus on the distribution of electronic components. Line cards we deal with include Microchip,ALPS,ROHM,Xilinx,Pulse,ON,Everlight and Freescale. Main products comprise IC,Modules,Potentiometer,IC Socket,Relay,Connector.Our parts cover such applications as commercial,industrial, and automotives areas.

We are looking forward to setting up business relationship with you and hope to provide you with the best service and solution. Let us make a better world for our industry!



Contact us

Tel: +86-755-8981 8866 Fax: +86-755-8427 6832

Email & Skype: info@chipsmall.com Web: www.chipsmall.com

Address: A1208, Overseas Decoration Building, #122 Zhenhua RD., Futian, Shenzhen, China



XW2B



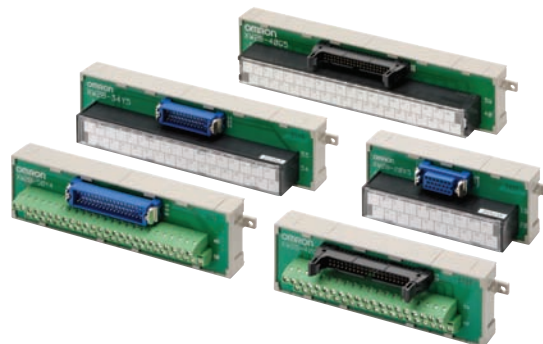

Simplifies Connector and terminal block replacement, and requires less in-panel wiring.

- Mount to DIN Track or via screws.
- MIL Flat Cable Connectors and Multi-pole, Square Connectors are standard.
- Terminal blocks available with either M3 or M3.5 screws.
- Connecting Cables for Programmable Controllers available (sold separately).

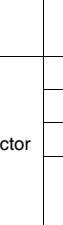
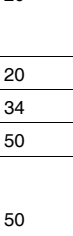

Ordering Information

Connectors

Type	Terminal Block	Connector	No. of poles	Appearance	Model
Flat Cable	Terminal block with M3 screws	Flat Cable Connectors *1	20		XW2B-20G4
			34		XW2B-34G4
			40		XW2B-40G4
			50		XW2B-50G4
			60		XW2B-60G4
	Terminal block with M3.5 screws		20		XW2B-20G5
			34		XW2B-34G5
			40		XW2B-40G5
			50		XW2B-50G5
			60		XW2B-60G5
Twin-connector	Terminal block with M3.5 screws	Flat Cable Connectors *1	40		XW2B-40G5-T
Daisy Chain			20		XW2B-20G5-D
Multi-pole, Square Connector	Terminal block with M3 screws	Multi-pole, Square Connector Plugs *2	20		XW2B-20Y4
			34		XW2B-34Y4
			50		XW2B-50Y4
	Terminal block with M3.5 screws		50		XW2B-50Y5

*1. Flat Cable Connectors have one polarity slot.

*2. These Plugs and Sockets are made by Honda Tsushin Kogyo.

Accessories (Order Separately)

Connecting Cables for Connector-Terminal Block Conversion Units

For details on the Connecting Cable used between XW2B Daisy Chain-type Connectors, refer to the *XW2Z datasheet*.

Ratings and Specifications

Item	Type	XW2B-□□G□ Flat Cable Units	XW2B-□□Y□ Multi-pole, Square-connector Units	XW2B-40F5-P Board I/O Unit
Rated current		1 A		
Rated voltage		125 VAC		
Insulation resistance		100 MΩ min. (at 500 VDC)		
Dielectric strength		500 VAC for 1 min (leakage current: 1 mA max.)		
Ambient operating temperature		0 to 55°C		

Dimensions

(Unit: mm)

Flat Cable Units with a Terminal Block with M3 Screws

XW2B-□□G4

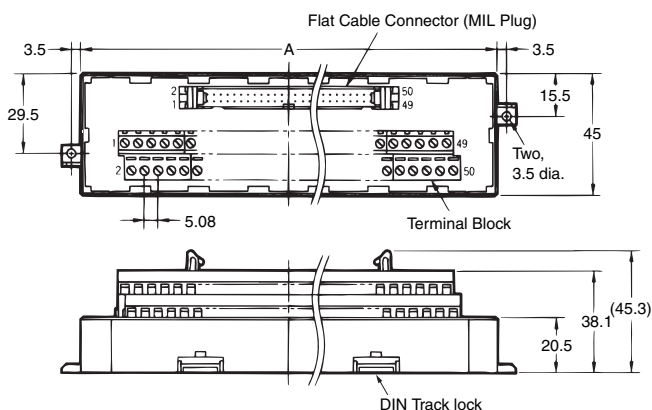
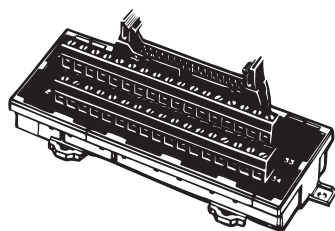

Wiring Diagram

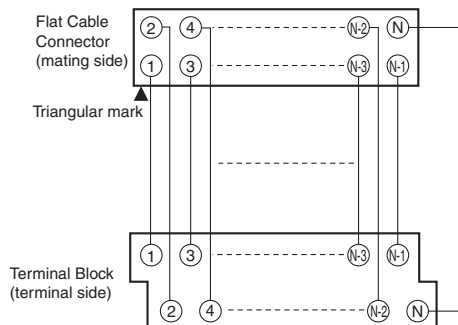

Note: All pins on the Flat Cable Connector correspond 1-to-1 to the terminal of the same number on the terminal block as shown above.

Dimensions

Model	No. of poles	Dimension A (mm)	Applicable Connector models *1
XW2B-20G4	20	67.5	XG4A-2031
XW2B-34G4	34	112.5	XG4A-3431
XW2B-40G4	40	135.0	XG4A-4031
XW2B-50G4	50	157.5	XG4A-5031
XW2B-60G4	60	180.0	XG4A-6031

*Flat Cable Connectors have one polarity slot.

Note: Terminal block pitch is 5.08 mm.

Use a wire size between 0.3 and 1.25 mm² (AWG22 to AWG16).

The wire insertion holes are 1.8 × 2.5 (H × W) mm.

Applicable Connectors

Model	Applicable Connectors (order separately)		
	Flat Cable Connectors, MIL Sockets with Strain Reliefs	Discrete-wire IDC Connectors, Double-row Sockets	
		Connectors *1	Semi-covers *2
XW2B-20G4	XG4M-2030-T	XG5M-2032-N XG5M-2035-N	XG5S-1001
XW2B-34G4	XG4M-3430-T	XG5M-3432-N XG5M-3435-N	XG5S-1701
XW2B-40G4	XG4M-4030-T	XG5M-4032-N XG5M-4035-N	XG5S-2001
XW2B-50G4	XG4M-5030-T	XG5M-5032-N XG5M-5035-N	XG5S-2501
XW2B-60G4	XG4M-6030-T	XG5M-6032-N XG5M-6035-N	XG5S-3001

*1. Either the XG5M-□□32-N or the XG5M-□□35-N may be used.

*2. Each Connector requires two Semi-covers.

Flat Cable Units with a Terminal Block with M3.5 Screws

XW2B-□□G5

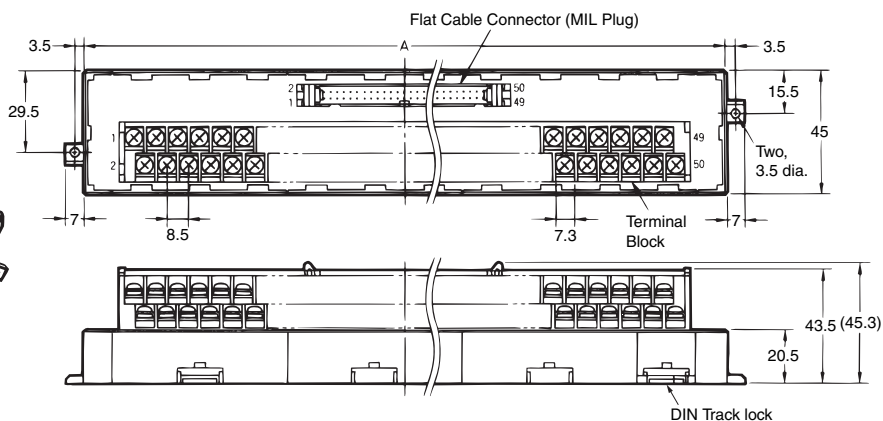
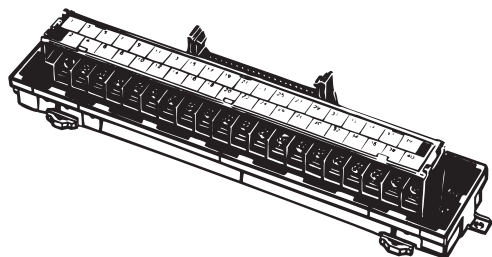

Wiring Diagram

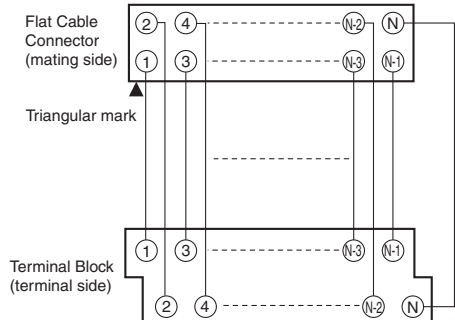

Note: All pins on the Flat Cable Connector correspond 1-to-1 to the terminal of the same number on the terminal block as shown above.

Dimensions

Model	No. of poles	Dimension A (mm)	Applicable Connector models *
XW2B-20G5	20	112.5	XG4A-2031
XW2B-34G5	34	180.0	XG4A-3431
XW2B-40G5	40	202.5	XG4A-4031
XW2B-50G5	50	247.5	XG4A-5031
XW2B-60G5	60	292.5	XG4A-6031

*Flat Cable Connectors have one polarity slot.

Note: Terminal block pitch is 8.5 mm.

Applicable Connectors

Model	Applicable Connectors (order separately)		
	Flat Cable Connectors, MIL Sockets with Strain Reliefs	Discrete-wire IDC Connectors, Double-row Sockets	
		Connectors *1	Semi-covers *2
XW2B-20G5	XG4M-2030-T	XG5M-2032-N XG5M-2035-N	XG5S-1001
XW2B-34G5	XG4M-3430-T	XG5M-3432-N XG5M-3435-N	XG5S-1701
XW2B-40G5	XG4M-4030-T	XG5M-4032-N XG5M-4035-N	XG5S-2001
XW2B-50G5	XG4M-5030-T	XG5M-5032-N XG5M-5035-N	XG5S-2501
XW2B-60G5	XG4M-6030-T	XG5M-6032-N XG5M-6035-N	XG5S-3001

*1. Either the XG5M-□□32-N or the XG5M-□□35-N may be used.

*2. Each Connector requires two Semi-covers.

Twin-connector Units with a Terminal Block with M3.5 Screws

XW2B-40G5-T

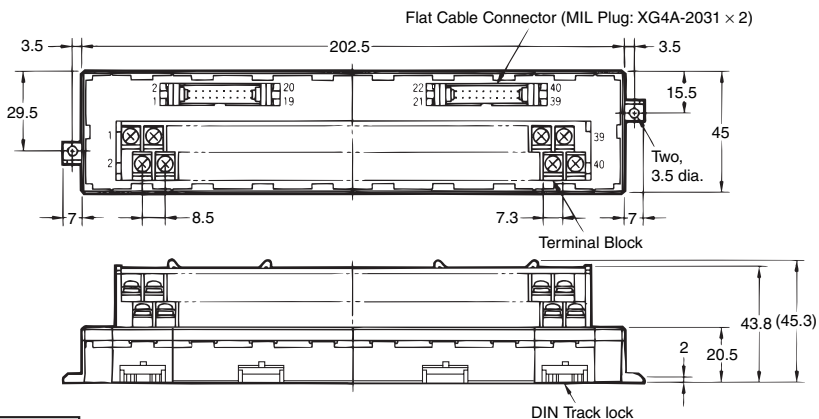
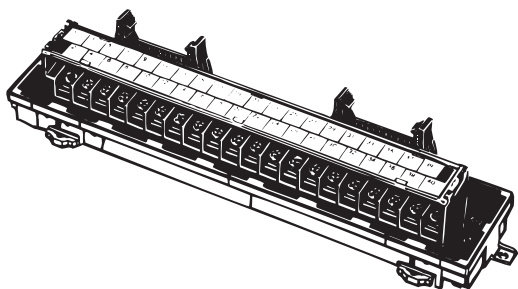

Wiring Diagram

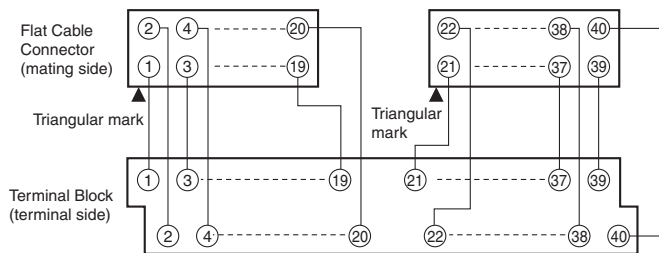

Note: All pins on the Flat Cable Connector correspond 1-to-1 to the terminal of the same number on the terminal block as shown above.

Applicable Connectors

Model	Applicable Connectors (order separately)		
	Flat Cable Connectors, MIL Sockets with Strain Reliefs	Discrete-wire IDC Connectors, Double-row Sockets	
		Connectors *1	Semi-covers *2
XW2B-40G5-T	XG4M-2030-T	XG5M-2032-N XG5M-2035-N	XG5S-1001

*1. Either the XG5M-□□32-N or the XG5M-□□35-N may be used.

*2. Each Connector requires two Semi-covers.

Daisy Chain Units with a Terminal Block with M3.5 Screws

XW2B-20G5-D

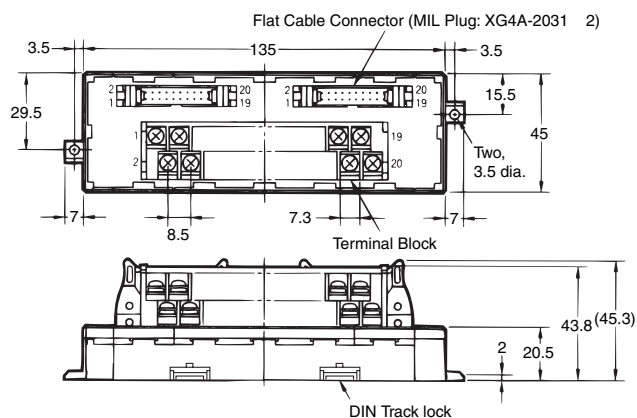
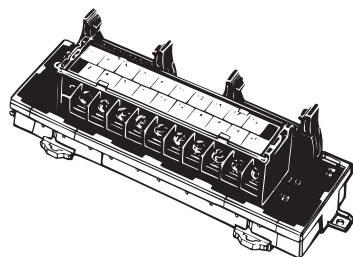

Wiring Diagram

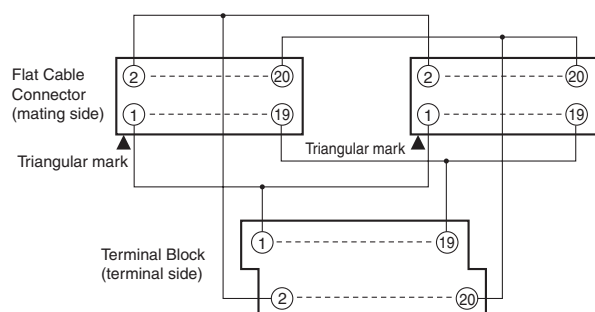

Note: All pins on the Flat Cable Connector correspond 1-to-1 to the terminal of the same number on the terminal block as shown above.

Applicable Connectors

Model	Applicable Connectors (order separately)		
	Flat Cable Connectors, MIL Sockets with Strain Reliefs	Discrete-wire IDC Connectors, Double-row Sockets	
		Connectors *1	Semi-covers *2
XW2B-20G5-D	XG4M-2030-T	XG5M-2032-N XG5M-2035-N	XG5S-1001

*1. Either the XG5M-□□32-N or the XG5M-□□35-N may be used.

*2. Each Connector requires two Semi-covers.

Multi-pole, Square-connector Plug Units with a Terminal Block with M3 Screws

XW2B-□□Y4

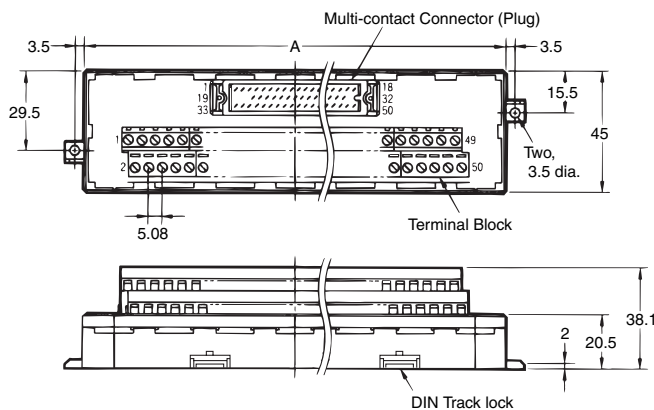
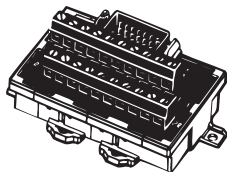

Wiring Diagram (Example for Terminal Block with 50 Poles)

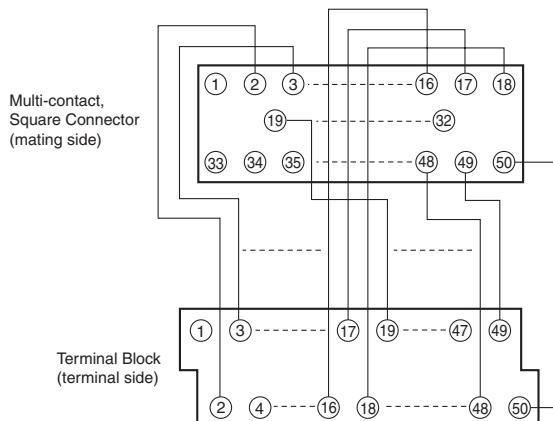

Note: All pins on the Multi-pole, Square Connector correspond 1-to-1 to the terminal of the same number on the terminal block as shown above.

Dimensions

Model	No. of poles	Dimension A (mm)	Applicable Connector models *
XW2B-20Y4	20	67.5	MR-20RMD2
XW2B-34Y4	34	112.5	MR-34RMD2
XW2B-50Y4	50	157.5	MR-50RMD2

*These Connectors are made by Honda Tsushin Kogyo.
 Note: Terminal block pitch is 5.08 mm.
 Use a wire size between 0.3 and 1.25 mm² (AWG22 to AWG16).
 The wire insertion holes are 1.8 × 2.5 (H × W) mm.

Applicable Connectors

Model	Applicable Connectors *1	Hood *1
XW2B-20Y4	MR-20F (soldered) MRP-20F01 (crimped) *2 MR-20FW (wrapped)	MR-20L
XW2B-34Y4	MR-34F (soldered) MRP-34F01 (crimped) *2 MR-34FW (wrapped)	MR-34L
XW2B-50Y4	MR-50F (soldered) MRP-50F01 (crimped) *2 MR-50FW (wrapped)	MR-50L

*1. All applicable Connector Hoods are made by Honda Tsushin Kogyo.
 *2. Use MRP-F113 or MRP-F103 crimp terminals made by Honda Tsushin Kogyo.

Multi-pole, Square-connector Plug Units with a Terminal Block with M3.5 Screws

XW2B-50Y5

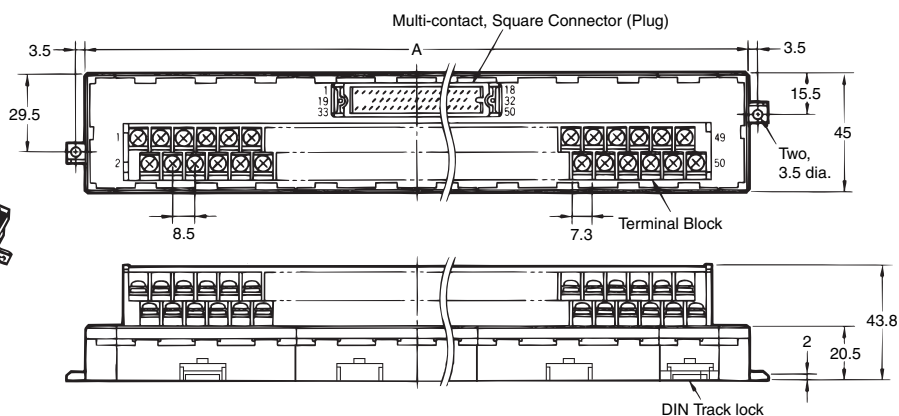
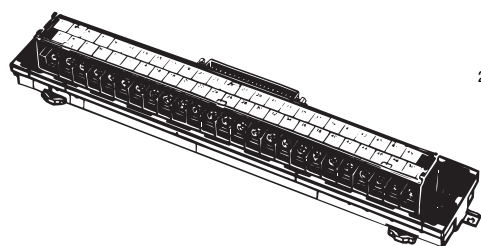

Wiring Diagram (Example for Terminal Block with 50 Poles)

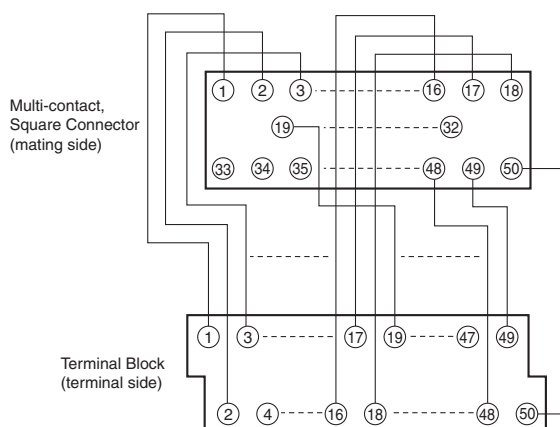

Note: All pins on the Multi-pole, Square Connector correspond 1-to-1 to the terminal of the same number on the terminal block as shown above.

Dimensions

Model	No. of poles	Dimension A (mm)	Applicable Connector models *
XW2B-50Y5	50	247.5	MR-50RMD2

*These Connectors are made by Honda Tsushin Kogyo.
Note: Terminal block pitch is 8.5 mm.

Applicable Connectors

Model	Applicable Connectors *1	Hood *1
XW2B-50Y5	MR-50F (soldered) MRP-50F01 (crimped) *2 MR-50FW (wrapped)	MR-50L

*1. All applicable Connector Hoods are made by Honda Tsushin Kogyo.

*2. Use MRP-F113 or MRP-F103 crimp terminals made by Honda Tsushin Kogyo.

Multi-pole, Square Connector Socket Units with a Terminal Block with M3.5 Screws

XW2B-□□X5

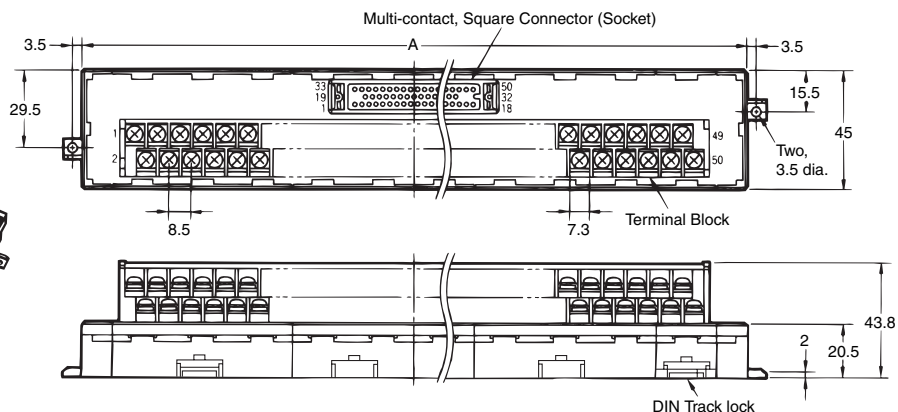
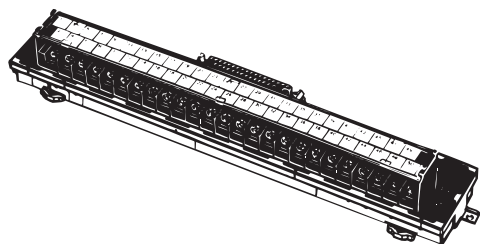

Wiring Diagram (Example for Terminal Block with 50 Poles)

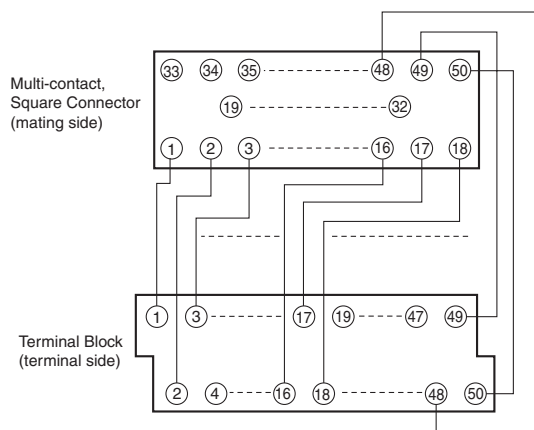

Note: All pins on the Multi-pole, Square Connector correspond 1-to-1 to the terminal of the same number on the terminal block as shown above.

Dimensions

Model	No. of poles	Dimension A (mm)	Applicable Connector models *
XW2B-20X5	20	112.5	MR-20RFD2
XW2B-34X5	34	180.0	MR-34RFD2
XW2B-50X5	50	247.5	MR-50RFD2

*These Connectors are made by Honda Tsushin Kogyo.
Note: Terminal block pitch is 8.5 mm.

Applicable Connectors

Model	Applicable Connectors *1	Hood *1
XW2B-20X5	MR-20M (soldered) MRP-20M01 (crimped) *2 MR-20MW (wrapped)	MR-20L
XW2B-34X5	MR-34M (soldered) MRP-34M01 (crimped) *2 MR-34MW (wrapped)	MR-34L
XW2B-50X5	MR-50M (soldered) MRP-50M01 (crimped) *2 MR-50MW (wrapped)	MR-50L

*1. All applicable Connector Hoods are made by Honda Tsushin Kogyo.

*2. Use MRP-F113 or MRP-F103 crimp terminals made by Honda Tsushin Kogyo.

Board I/O Units with a Terminal Block with M3.5 Screws

XW2B-40F5-P

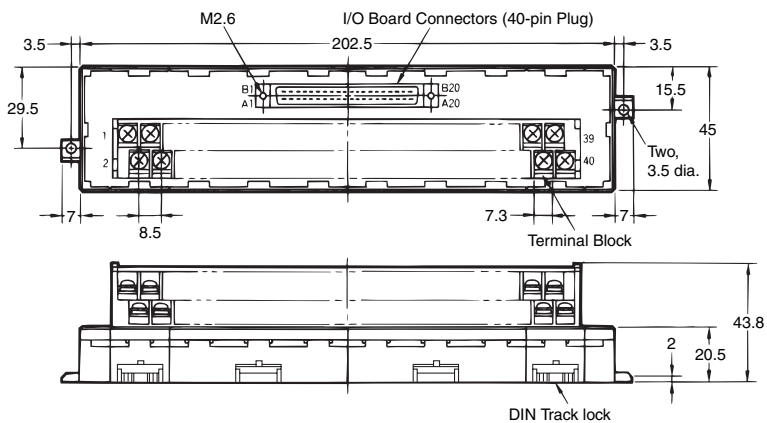
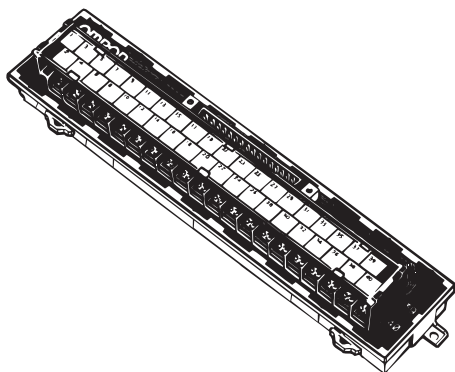

Wiring Diagram

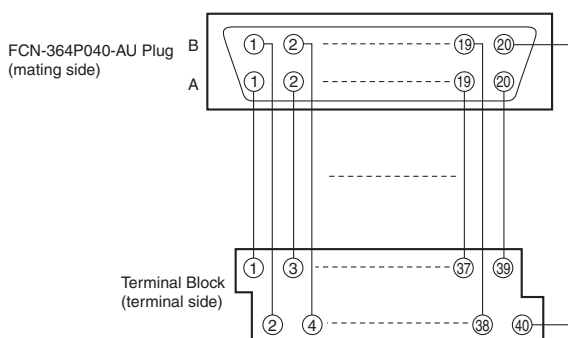

Dimensions

Model	No. of poles	Applicable Connectors and Circuits *
XW2B-40F5-P	40	FCN-364P40-AU (Connector) FCN-360A1 (Anchor)

*These Connectors and circuits are made by Fujitsu component.
Note: Terminal block pitch is 8.5 mm.

Applicable Connectors

Model	Applicable Connectors *1	Hood *1
XW2B-40F5-P	FCN361J040-AU (soldered) FCN363J040-AAU (crimped)	FCN360C040-B

*1. All applicable Connectors and Covers are made by Fujitsu component.

*2. Refer to the *OMNUC U Series user's manual* for details on the Connecting Cable used between the XW2B-40F5-P and the U-series AC Servo Driver.

Safety Precautions

Precautions for Correct Use

● Wiring

- Always turn OFF the power supply before wiring. Otherwise, cables or other conductors can short the terminals and cause the Unit to fail.
- Do not connect or disconnect Connectors with the power turned ON. Otherwise, it may cause malfunctions.

● Wiring Terminal Blocks

- Direct Wire Connections with a Terminal Block with M3 Screws
 1. Use a wire size between 0.3 and 1.25 mm² (AWG22 to AWG16).
 2. Prepare the end of each wire as shown in the following diagram.



3. The wire insertion holes are 1.8 × 2.5 (H × W) mm on the terminal block with M3 screws.

- Direct Wire Connections with a Terminal Block with M3.5 Screws

Round

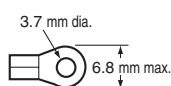

Forked

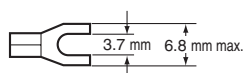

	Applicable crimp terminals	Applicable wires
Round	1.25-3.5	AWG22 to AWG16 (0.30 to 1.25 mm ²)
	2-3.5	AWG16 to AWG14 (1.25 to 2.0 mm ²)
Forked	1.25Y-3.5	AWG22 to AWG16 (0.30 to 1.25 mm ²)
	2Y-3.5	AWG16 to AWG14 (1.25 to 2.0 mm ²)

(With a Terminal Block with M3 Screws)

Round rod

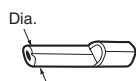

Blade

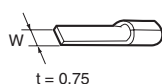

	Applicable crimp terminals	Applicable wires
Rod	TC-05 Dia. = 1	AWG22 to AWG18 (0.30 to 0.75 mm ²)
	TC-1.25S Dia. = 1.5	AWG22 to AWG16 (0.30 to 1.25 mm ²)
Blade	BT1.25-9-1 BT1.25-10-1 W = 2.2	AWG22 to AWG16 (0.30 to 1.25 mm ²)

Note: Round rod and blade crimp terminals are made by Nichifu.

● Terminal Screw Tightening Torque

- Select a tightening torque from the following table when connecting wires or crimp terminals to the terminal block.

Terminal Block	Tightening torque N·m
With M3 screws	0.40
With M3.5 screws	0.59

● Mounting Units to and Removing Units from DIN Track

- For terminal blocks with M3 screws, use a flat-head screwdriver like the one shown in the following diagram.

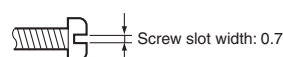
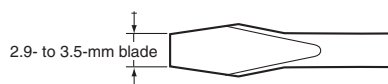

- XW2B Connector-Terminal Block Conversion Units can be mounted side-to-side on DIN Track. The flanges for mounting screws are located on each side at the bottom of the XW2B.
- Secure both ends of the XW2B with End Plates.
- When removing the Unit from a DIN Track, insert a flat-head screwdriver into the slider and pull the lock out.

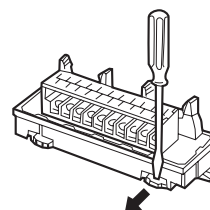

Terms and Conditions Agreement

Read and understand this catalog.

Please read and understand this catalog before purchasing the products. Please consult your OMRON representative if you have any questions or comments.

Warranties.

(a) Exclusive Warranty. Omron's exclusive warranty is that the Products will be free from defects in materials and workmanship for a period of twelve months from the date of sale by Omron (or such other period expressed in writing by Omron). Omron disclaims all other warranties, express or implied.

(b) Limitations. OMRON MAKES NO WARRANTY OR REPRESENTATION, EXPRESS OR IMPLIED, ABOUT NON-INFRINGEMENT, MERCHANTABILITY OR FITNESS FOR A PARTICULAR PURPOSE OF THE PRODUCTS. BUYER ACKNOWLEDGES THAT IT ALONE HAS DETERMINED THAT THE PRODUCTS WILL SUITABLY MEET THE REQUIREMENTS OF THEIR INTENDED USE.

Omron further disclaims all warranties and responsibility of any type for claims or expenses based on infringement by the Products or otherwise of any intellectual property right. (c) Buyer Remedy. Omron's sole obligation hereunder shall be, at Omron's election, to (i) replace (in the form originally shipped with Buyer responsible for labor charges for removal or replacement thereof) the non-complying Product, (ii) repair the non-complying Product, or (iii) repay or credit Buyer an amount equal to the purchase price of the non-complying Product; provided that in no event shall Omron be responsible for warranty, repair, indemnity or any other claims or expenses regarding the Products unless Omron's analysis confirms that the Products were properly handled, stored, installed and maintained and not subject to contamination, abuse, misuse or inappropriate modification. Return of any Products by Buyer must be approved in writing by Omron before shipment. Omron Companies shall not be liable for the suitability or unsuitability or the results from the use of Products in combination with any electrical or electronic components, circuits, system assemblies or any other materials or substances or environments. Any advice, recommendations or information given orally or in writing, are not to be construed as an amendment or addition to the above warranty.

See <http://www.omron.com/global/> or contact your Omron representative for published information.

Limitation on Liability; Etc.

OMRON COMPANIES SHALL NOT BE LIABLE FOR SPECIAL, INDIRECT, INCIDENTAL, OR CONSEQUENTIAL DAMAGES, LOSS OF PROFITS OR PRODUCTION OR COMMERCIAL LOSS IN ANY WAY CONNECTED WITH THE PRODUCTS, WHETHER SUCH CLAIM IS BASED IN CONTRACT, WARRANTY, NEGLIGENCE OR STRICT LIABILITY.

Further, in no event shall liability of Omron Companies exceed the individual price of the Product on which liability is asserted.

Suitability of Use.

Omron Companies shall not be responsible for conformity with any standards, codes or regulations which apply to the combination of the Product in the Buyer's application or use of the Product. At Buyer's request, Omron will provide applicable third party certification documents identifying ratings and limitations of use which apply to the Product. This information by itself is not sufficient for a complete determination of the suitability of the Product in combination with the end product, machine, system, or other application or use. Buyer shall be solely responsible for determining appropriateness of the particular Product with respect to Buyer's application, product or system. Buyer shall take application responsibility in all cases.

NEVER USE THE PRODUCT FOR AN APPLICATION INVOLVING SERIOUS RISK TO LIFE OR PROPERTY OR IN LARGE QUANTITIES WITHOUT ENSURING THAT THE SYSTEM AS A WHOLE HAS BEEN DESIGNED TO ADDRESS THE RISKS, AND THAT THE OMRON PRODUCT(S) IS PROPERLY RATED AND INSTALLED FOR THE INTENDED USE WITHIN THE OVERALL EQUIPMENT OR SYSTEM.

Programmable Products.

Omron Companies shall not be responsible for the user's programming of a programmable Product, or any consequence thereof.

Performance Data.

Data presented in Omron Company websites, catalogs and other materials is provided as a guide for the user in determining suitability and does not constitute a warranty. It may represent the result of Omron's test conditions, and the user must correlate it to actual application requirements. Actual performance is subject to the Omron's Warranty and Limitations of Liability.

Change in Specifications.

Product specifications and accessories may be changed at any time based on improvements and other reasons. It is our practice to change part numbers when published ratings or features are changed, or when significant construction changes are made. However, some specifications of the Product may be changed without any notice. When in doubt, special part numbers may be assigned to fix or establish key specifications for your application. Please consult with your Omron's representative at any time to confirm actual specifications of purchased Product.

Errors and Omissions.

Information presented by Omron Companies has been checked and is believed to be accurate; however, no responsibility is assumed for clerical, typographical or proofreading errors or omissions.

2017.6

In the interest of product improvement, specifications are subject to change without notice.

OMRON Corporation
Industrial Automation Company

<http://www.ia.omron.com/>

(c)Copyright OMRON Corporation 2017 All Right Reserved.