



Chipsmall Limited consists of a professional team with an average of over 10 year of expertise in the distribution of electronic components. Based in Hongkong, we have already established firm and mutual-benefit business relationships with customers from,Europe,America and south Asia,supplying obsolete and hard-to-find components to meet their specific needs.

With the principle of “Quality Parts,Customers Priority,Honest Operation,and Considerate Service”,our business mainly focus on the distribution of electronic components. Line cards we deal with include Microchip,ALPS,ROHM,Xilinx,Pulse,ON,Everlight and Freescale. Main products comprise IC,Modules,Potentiometer,IC Socket,Relay,Connector.Our parts cover such applications as commercial,industrial, and automotives areas.

We are looking forward to setting up business relationship with you and hope to provide you with the best service and solution. Let us make a better world for our industry!



Contact us

Tel: +86-755-8981 8866 Fax: +86-755-8427 6832

Email & Skype: info@chipsmall.com Web: www.chipsmall.com

Address: A1208, Overseas Decoration Building, #122 Zhenhua RD., Futian, Shenzhen, China





OMRON

FQM1 Series Flexible Motion Controllers

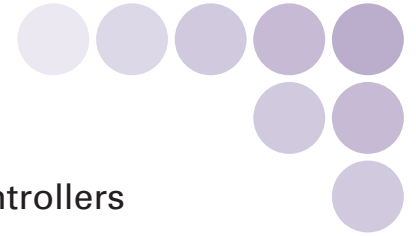

A New Concept in Motion Controllers
for Ideal Machine Operation



Note: Do not use this document to operate the Unit.

Printed on 100%
Recycled Paper



OMRON Corporation
Control Devices Division H.Q.
Shiojohji Horikawa, Shimogyo-ku,
Kyoto, 600-8530 Japan
Tel: (81)75-344-7109
Fax: (81)75-344-7149

Regional Headquarters

OMRON EUROPE B.V.
Wegalaan 67-69, NL-2132 JD Hoofddorp
The Netherlands
Tel: (31)2356-81-300/
Fax: (31)2356-81-388

OMRON ELECTRONICS LLC
1 East Commerce Drive, Schaumburg,
IL 60173 U.S.A.
Tel: (1)847-843-7900/Fax: (1)847-843-8568

OMRON ASIA PACIFIC PTE. LTD.
83 Clemenceau Avenue,
#11-01, UE Square,
Singapore 239920
Tel: (65)6835-3011/Fax: (65)6835-2711

OMRON (CHINA) CO., LTD.
Room 2211, Bank of China Tower,
200 Yin Cheng Zhong Road,
PuDong New Area, Shanghai, 200120 China
Tel: (86)21-5037-2222/Fax: (86)21-5037-2200

Authorized Distributor:

Note: Specifications subject to change without notice.

Cat. No. O901-E1-02
Printed in Japan
0206-1M



realizing

Advanced Power in Three Applications: Motion Control, Measurement Control, and High-speed Response Control

The All New FQM (Flexible Quick Motion)[®]

The FQM1 now supports I/O expansion, communications slaves, multiaxis control, data storage, and function block /structured text programming.

Flexibility, quickness, and a wide range of advanced motion operations enable the FQM1 to easily handle applications in the following three control areas.

1 Motion Control

2 Measurement Control

3 High-speed Response Control

The all new FQM1-CM002/MMA22/MMP22 (FQM1-series unit version 3.0) can be expanded using CJ-series Units. In addition, function block and structured text programming are supported.

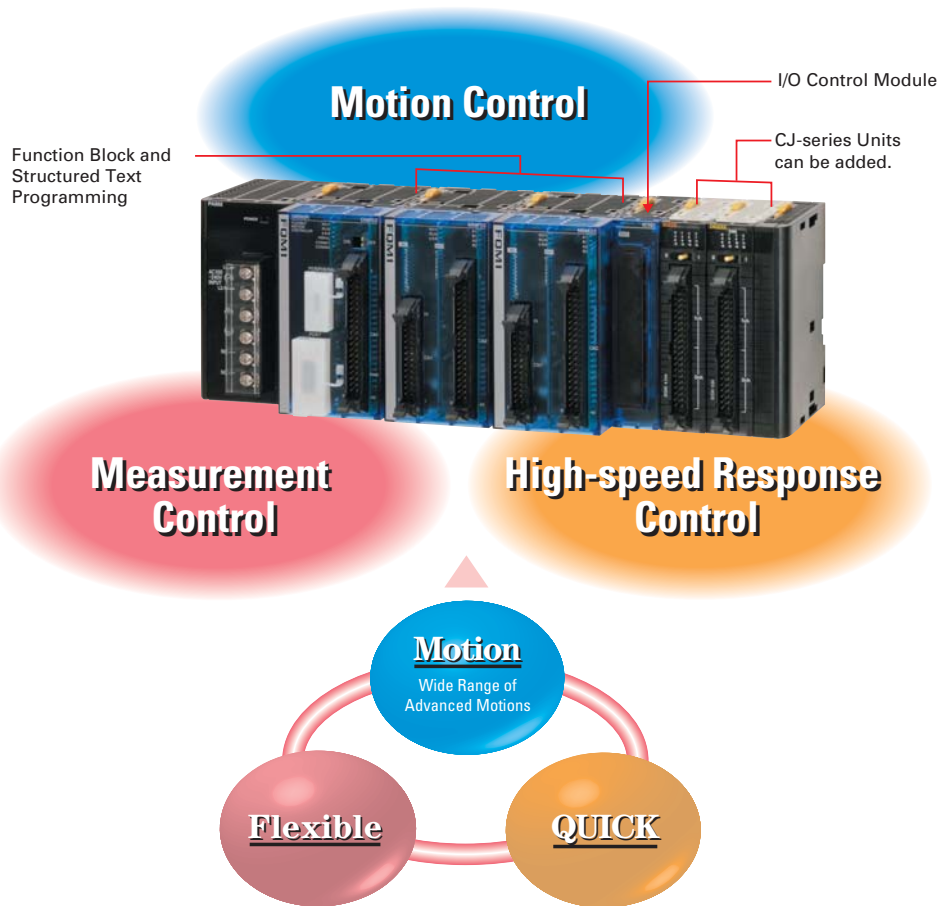

For the Non-stop Control Ideal for Applications Performing Processing without Stopping Machinery Operation

To improve machinery performance, it is important to increase productivity by eliminating waste. Here, the FQM1 really performs to enable processing that must be achieved without stopping machinery operation.

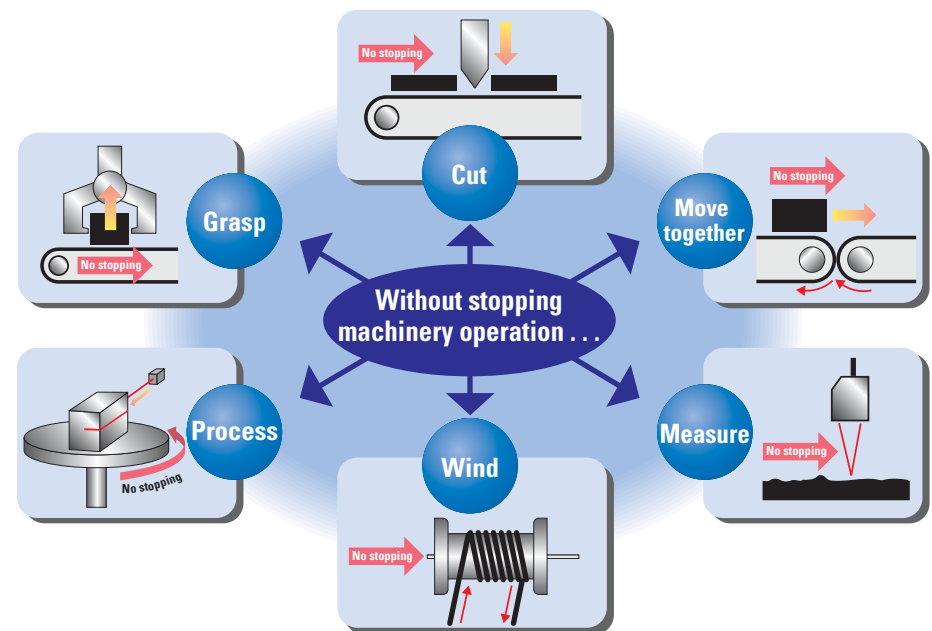

Multiple axes can be controlled as required by the application.
Simultaneously control up to 8 axes for high-speed response control and up to 16 axes for PTP control.

Position of the FQM1 among OMRON Products

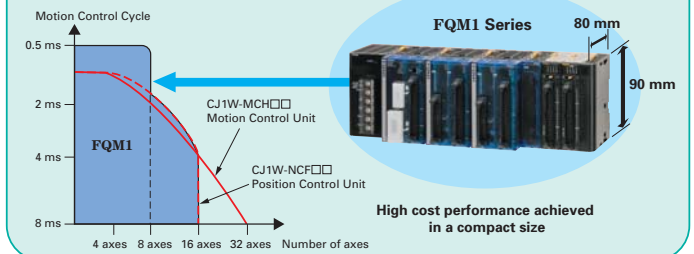

High cost performance achieved in a compact size

A Variety of Applications Accomplished with Motion, Measurement, and High-speed Response

High-level Wide-ranging Motion Achieved from F (Flexibility) and Q (Quickness).

From High-speed PTP Control to Synchronous, Torque, and Tension Control

Pulse/analog I/O feedback gives the FQM1 power in high-speed I/O applications.

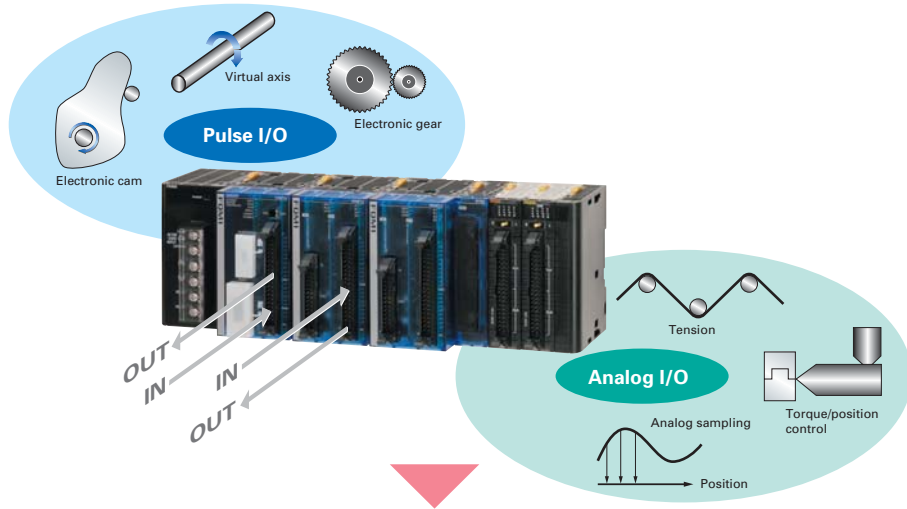

Wide-ranging FQM1 Applications

In addition to motion control, the FQM1 handles the following control areas through its ability to perform high-speed I/O processing through feedback from analog or pulse input data. Actual applications have already been implemented.

Control Category		Application example	
Motion control	Synchronous control	Rotary cutters	Packaging machines
		Flying cutters	Traveling cutters
		Electronic cams	Processing line and lens processing
	Line control	Tension control	Winding and feeding
		Draw control	Paper feeding
	Torque control	Torque control	Injection molding
		Torque limit	Molding and pressing
	Tracking control	CP control	Processing and coating
Traverse control		Winding	
Measurement control	Analog systems	High-speed analog sampling	Sheet thickness inspection and quality management
		High-speed PID control	Distance constant control
	Pulse systems	High-speed counters	Measurement (high-speed) and F/V conversion
High-speed response control	I/O control	Synchronous startup	Conveyers
		Interrupt feeding	Labelers
		High-speed PTP control	Conveyers
		High-speed counters	Conveyers

Motion Control Applications

The FQM1 Achieves High-precision Trailing Using High-speed Control Cycles

High-precision trailing with little fluctuation is possible due to the high-speed responsiveness of the FQM1. An instruction for line segment approximation can be used during operation to change the pattern of the curve.

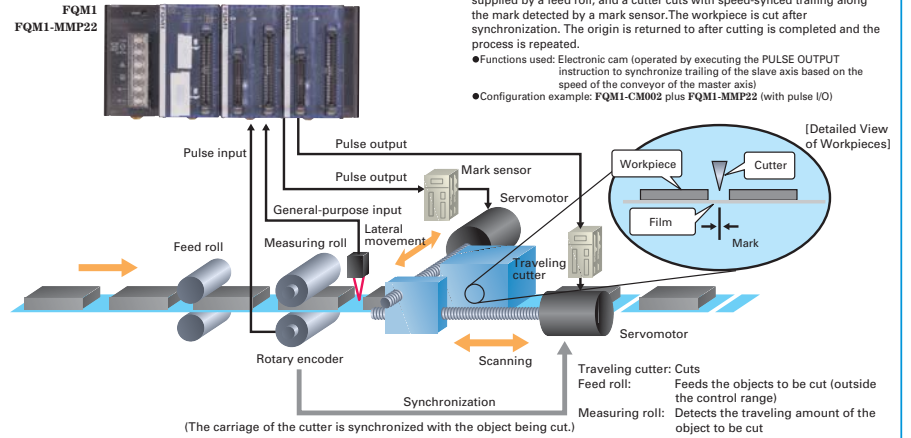

The high-speed cycle and processing method of the FQM1 enable flexible cam patterns.

The high-speed cycle and high level of processing functions enable synchronous control of electronic cams using either a cam table method or a data processing method. In particular, when the data processing method is used, it is possible to realize a high-speed control cycle during processing, enabling the cam to be changed during operation. When using the cam table method, tables can be linked and used even while switching cam tables, enabling high-resolution curves.

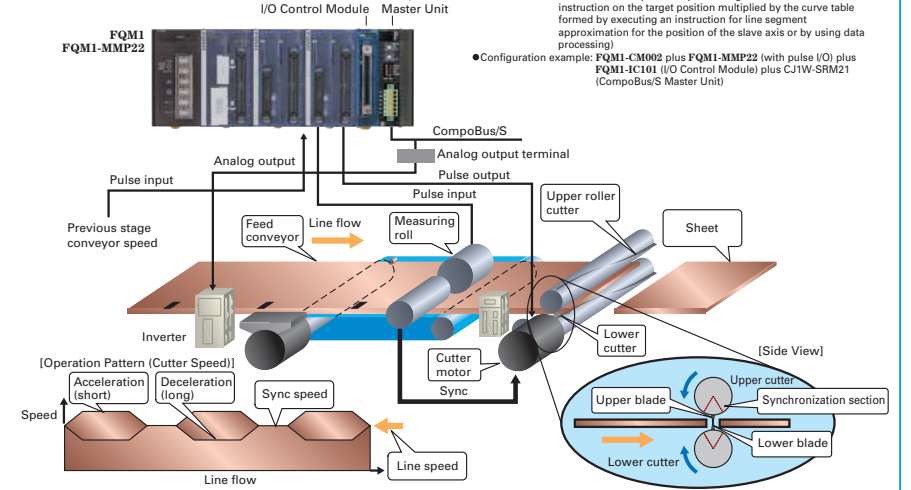

FQM1 High-speed Control Cycles and High Resolution Enable Free Speed Control

Process without stopping.

The FQM1 high-speed control cycle enables various speed controls required in production equipment such as molding machines (injection speed, mold clamping/mold opening, screw turning speed, etc.) to be programmed in detail. In particular, high-precision control is achieved by incorporating feedback using analog input, servo drive SPEED commands, and analog output.

Application Examples Speed control for injection molding machine
Torque control for extruding and pressing

For example, the amount of material pushed into the molding machine and the pressure are controlled. Position control (the output amount equals the number of rotations) and torque control (the pressing pressure equals the pressure) are performed during operation.

- Functions used: Switching from position control (SPEED command) to pressure control (SPEED command and torque limit) to Position Control (SPEED command)
- Configuration example: FQM1-CM002 plus FQM1-MMA22 (with analog I/O) plus FQM1-IC101 (I/O Control Module)

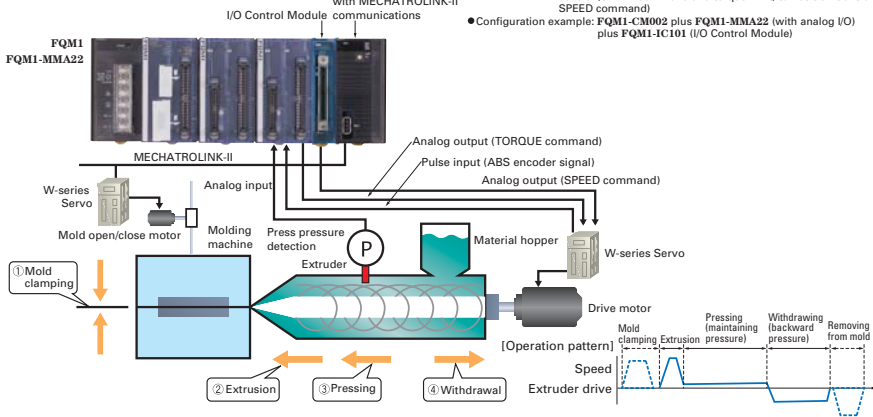

The FQM1 High-speed Feedback Loop Enables Stable Control

Convey together without stopping.

High-speed analog I/O and a high-speed control cycle enable stable line control. A high-speed feedback loop for controlling the motor speed can be set up with the analog input data from the dancer roller or the tension detector. Also, the internal program can be flexibly combined for compensation processing.

Application Examples Winding, feeding control

For example, the tautness can be controlled by adjusting the speed of the feeding axis and the winding axis while detecting the position of the dancer roller using an analog input.

- Functions used: Analog I/O, PI with ladder program, ratio calculations
- Configuration example: FQM1-CM002 plus FQM1-MMA22 (with analog I/O) plus FQM1-MMA22 (with analog I/O)

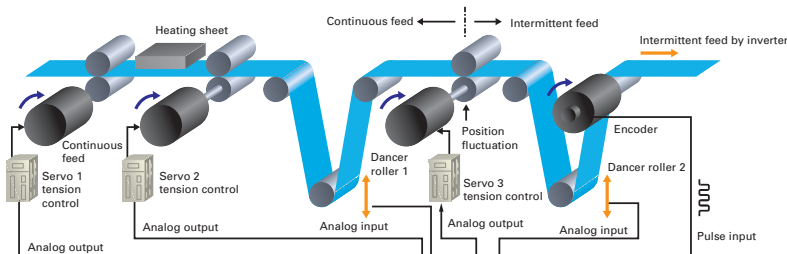

To stretch the material, servo 1 is operated slower than servo 2. Fine control is performed with an electronic gear.

The speed of servo 2 is determined based on the command speed of servo 3 and the displacement amount of dancer roller 1.



FQM1 FQM1-MMA22 FQM1-MMA22

The speed of servo 3 is determined based on the pulse count from the encoder and the displacement amount of dancer roller 2.

The FQM1 High-speed Control Cycle Enables High-precision Processing

Process without stopping.

Applying synchronous control of the electronic cam, the FQM1 high-speed control cycle can be used to achieve minute tracking control during processing. The ability to execute position commands in a high-speed control cycle of 1 to 2 ms enables improved manufacturing accuracy even for complicated processes, such as linear interpolation, circular interpolation, and elliptical interpolation, can be performed by changing the target position.

Application Examples Gluing, welding, or grinding a design to a unique shape

For example, taking the master axis as the base axis, two real axes are synchronized to the base axis, and then a tracking pattern is formed with an instruction for line segment approximation to set the target position.

- Functions used: Synchronous control of the electronic cam, linking of the line segment pattern using an instruction for line segment approximation
- Configuration example: FQM1-CM002 plus FQM1-MMP22 (with pulse I/O)

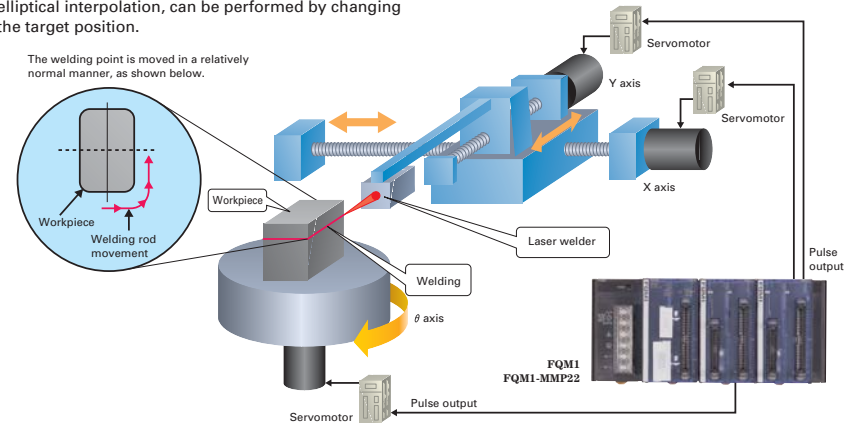

High-quality Winding Control with the FQM1's High-speed Control Cycle

Wind without stopping.

High-speed pulse I/O and a high-speed control cycle are used to achieve high-quality winding control. An accurate winding pitch is achieved by controlling the relation between the spindle and the traverse amount using an electronic cam system and tracking the transverse motion to the gradually changing rotational amount of the spindle.

Application Examples Wire/Thread Winding Control

For example, the transverse motion is controlled using an electronic cam system in response to spindle commands or rotation feedback.

- Functions used: Synchronous control of the electronic cam, switching of the linear pattern using an instruction for linear approximation
- Configuration example: FQM1-CM002 plus FQM1-MMP22 (with pulse I/O)

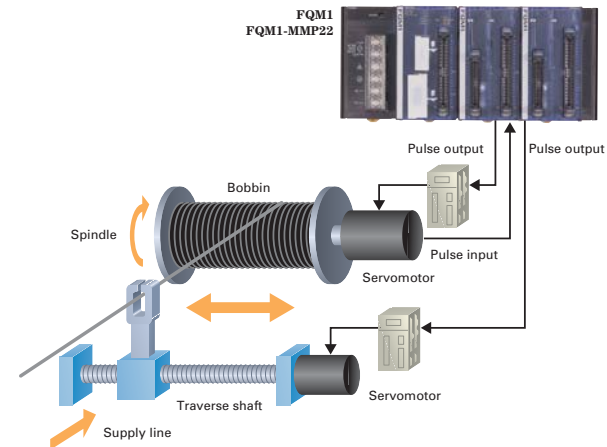

The High-speed Control Cycle and Processing Power of the FQM1 Expand the Range of Synchronous Control.

Process without stopping

A high-speed control cycle and high-performance processing power enable synchronous control of the electronic cam, thereby enabling processing without stopping the line.

Application Examples Label printing

For example, printing can be performed on items flowing along the line without stopping by rotating the printing drum synchronized with the line speed.

- Functions used: Synchronous control of the electronic cam, high-speed processing
- Configuration example: FQM1-CM002 plus FQM1-MMP22 (with pulse I/O)

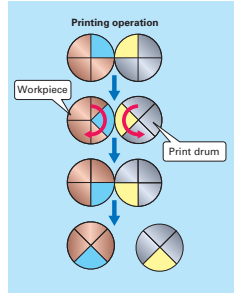
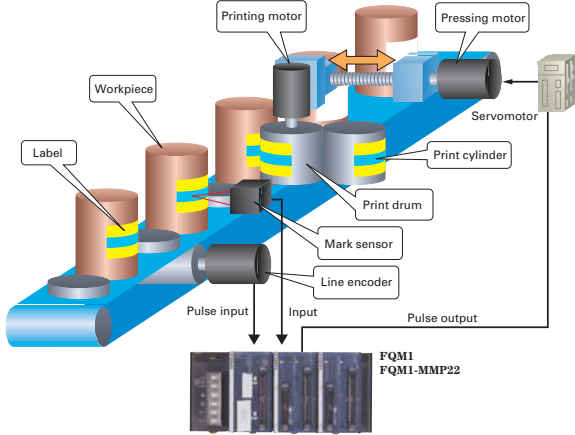

Use the FQM1 Synchronized Data Function to Enable Synchronized Compensation Control

Convey together without stopping

With the FQM1, the data held by the Motion Control Modules can be shared by using a sync bus. Analog data shared in this way can be used as compensation for position control.

Application Examples • Process by maintaining a uniform distance from products that warp during processing
• Feed control for parallel conveyors

For example, while the base hoist axis synchronized to the table position is controlled with pulse input data by the FQM1-MMP22, analog input data, such as that from a displacement sensor, can be obtained via a sync bus from the FQM1-MMA22 and used to compensate the hoist axis control.

- Functions used: Sync data function
- Configuration example: FQM1-CM002 plus FQM1-MMA22 (with analog I/O) plus FQM1-MMP22 (with pulse I/O)

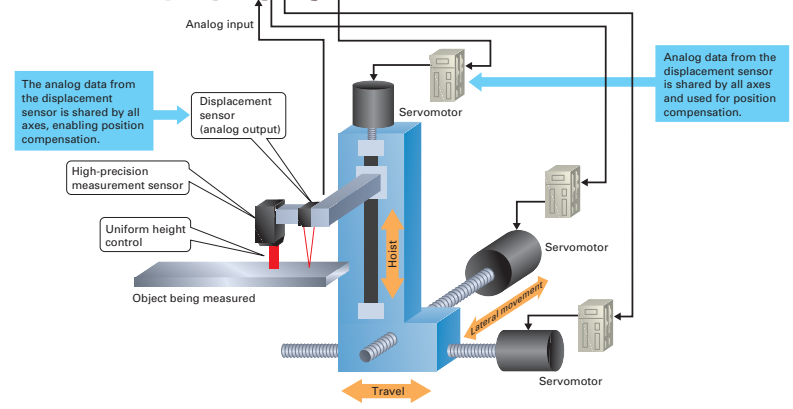

Measurement Control Applications

High-speed Analog Sampling Synced on an FQM1 Pulse Input

Measure without stopping

The FQM1-MMA22 has a high-speed sampling and storage function for analog input data that is synced with input pulses (i.e., the position of the target object). This achieves sampling performance beyond that achieved with conventional controllers, and also supports sampling in sync with an external signal, whereas only sampling over specified times was possible until now.

Application Examples • Quality analysis by detecting warping or other conditions of minutely processed products
• Condition data collection during processes

For example, by collecting multipoint displacement data over the course of changes in the position of the target object from one position to another, the warping or other conditions of minutely processed products can be detected and quality analyzed.

- Functions used: High-speed analog sampling
- Configuration example: FQM1-CM002 plus FQM1-MMA22 (with analog I/O)

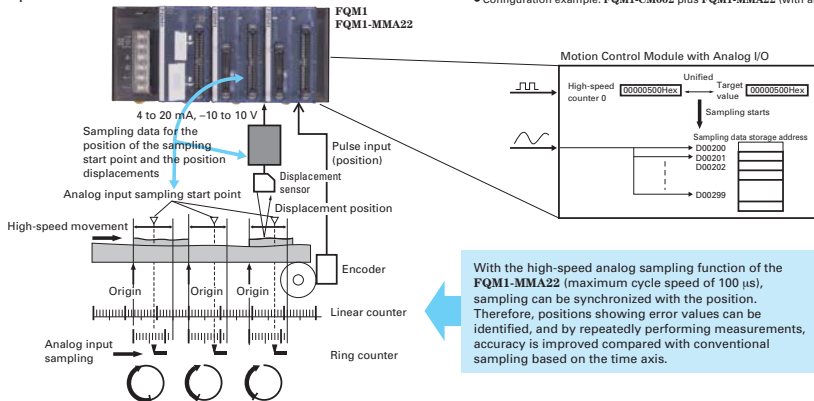

With the high-speed analog sampling function of the FQM1-MMA22 (maximum cycle speed of 100 μs), sampling can be synchronized with the position. Therefore, positions showing error values can be identified, and by repeatedly performing measurements, accuracy is improved compared with conventional sampling based on the time axis.

High-speed Response Control Applications

Flexible Speed Control with Freely Controlled Pulse Outputs

With the renewed FQM1, the freedom in speed control has been greatly increased by using pulse outputs. In the operation of infinite-axis feeding, the rotation speed can be changed by changing the frequency of the pulse output as desired based on the time axis.

Application Examples Speed Control for Infinite-axis Feeding

For example, the ideal rotational operation can be performed for the speed of a rotating body by changing the speed or acceleration/deceleration as desired over time.

- Functions used: ACC instruction (ACCELERATION CONTROL)
- Configuration example: FQM1-CM002 plus FQM1-MMP22 (with pulse I/O)

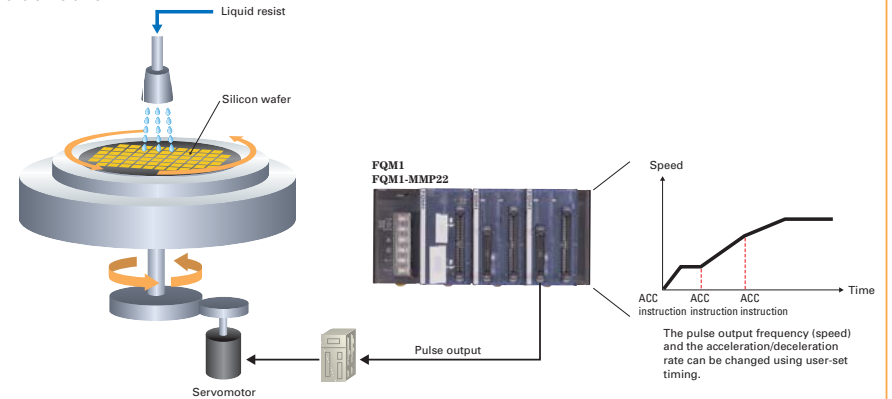

Pulse Output Control with the FQM1's High-speed Input Response

Sensor inputs can be detected with high precision by using the **FQM1**'s dependable interrupt input response and the high-speed input latching function for pulse inputs. This improves precision when switching or stopping machine operation and performing processing from sensor inputs.

Application Examples **Labeler**

For example, the stop function can be performed with high-precision stop positioning at a position a constant distance forward after the sensor input has entered.

- Functions used: Interrupt input function, pulse latch function
- Configuration example: **FQM1-CM002** plus **FQM1-MMP22** (with pulse I/O)

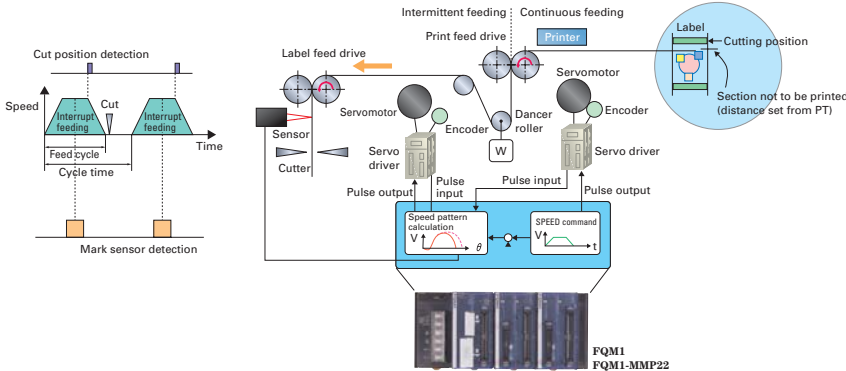

Timing Control with the FQM1's Pulse Inputs

The pulse input and high-precision output functions of the **FQM1** provide support to perform processing at a specific distance after detection for when processing cannot be performed based on time after an ON/OFF sensor detects an object or when precision is insufficient.

Application Examples **Cutting printing materials**
Nozzle exposure on items flowing at high-speed

For example, the output can be controlled with high-precision time control after the target number of pulses has been counted after the sensor has been input when processing with high-precision is required at a specified distance advanced (with timing generated from a number of pulses) after the sensor input has been received.

- Functions used: Pulse input-target value match interrupt function, one-shot pulse output function (See note.)
- Configuration example: **FQM1-CM002** plus **FQM1-MMP22** (with pulse I/O)
- Note: Also applicable as a 1- μ s high-precision timer.

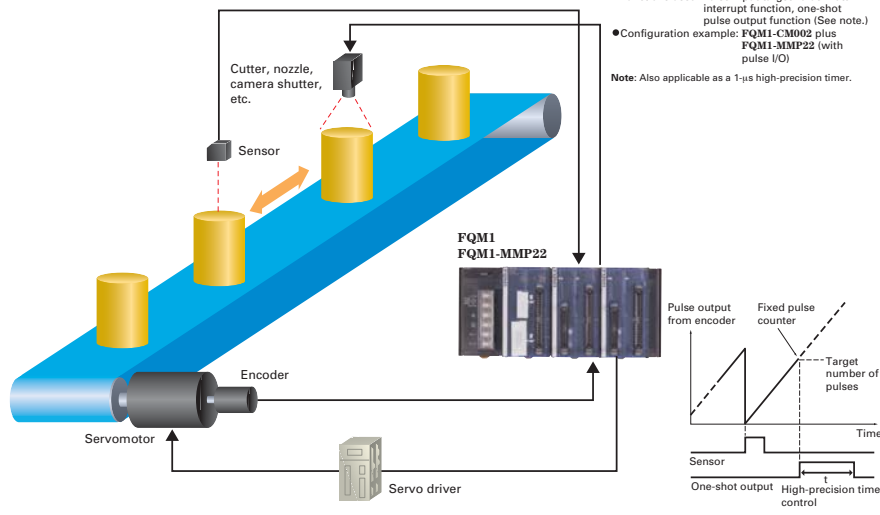

For the Optimal Control Customers Demand for Their Machines Flexible

Flexible System Configuration Using Modular Configuration

The **FQM1** consists of a Power Supply Module, a Coordinator Module, Motion Control Modules, and an End Module. Motion Control Modules are available with pulse I/O or analog I/O, and up to four Motion Control Modules of either type can be connected. (See note.) Each Motion Control Module controls two axes. Therefore, when four

Modules are connected, motion control can be performed for up to eight axes. Also, CJ-series Units can be mounted if an I/O Control Module is used, enabling a flexible system configuration to meet the needs of the application.

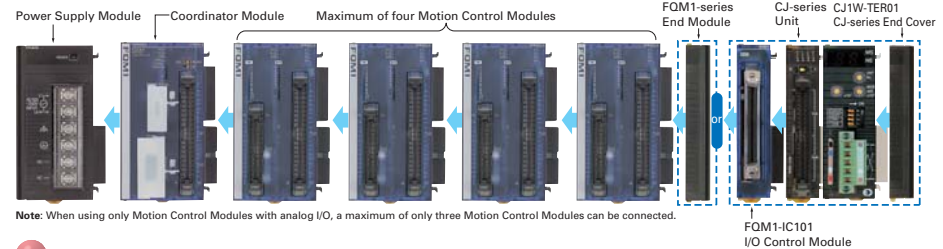

I/O and Other Functions Expandable with CJ-series Units

Some of the PLC SYSMAC CJ-series Units can be used by mounting an I/O Control Module for the FQM1 to the **FQM1**. CJ-series Units can be connected on the right end

of the **FQM1** or using the CJ-series I/O Interface Unit with up to one Expansion Rack.

Example 1: Expansion with CJ-series Basic I/O Units

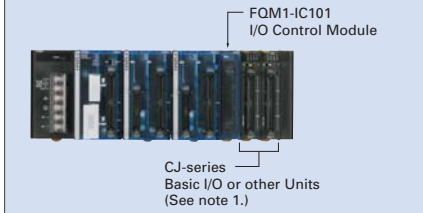

Example 2: Expansion with CJ-series Expansion Rack

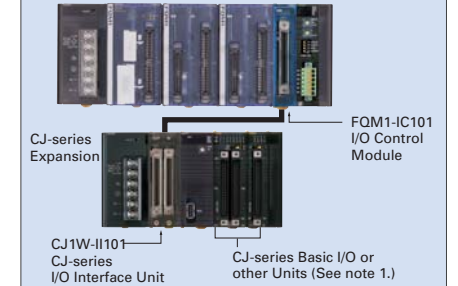

Example 3: I/O Expansion and Reduced Wiring with CompoBus/S

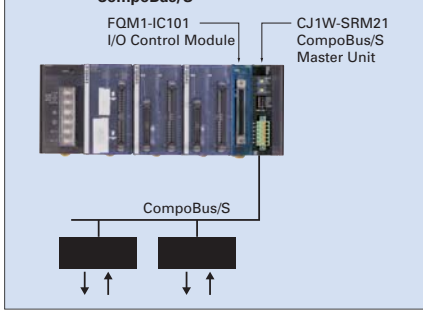

Example 4: Expansion with Multi-axis Position Control Units

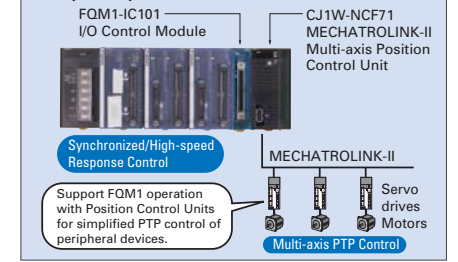

- Note 1:** The follow CJ-series Units can be connected as long as the current consumption does not exceed the supply capacity.
- CJ-series Basic I/O Units • CompoBus/S Master Units • DeviceNet Units • Position Control Units (NCF Units) with MECHATROLINK-II (See note 2.)
 - SYSMAC SPU High-speed Data Collection Unit

Note 2: MECHATROLINK is a registered trademark of Yaskawa Electric Corporation.

For the Optimal Control Customers Demand for Their Machines Flexible

Each Module Controls I/O Directly

The **FQMI** distributes control to each Module, and each Module controls I/O directly. The Motion Control Modules and Coordinator Module independently execute their own ladder programming, enabling independent, high-speed processing of analog and or pulse I/O controls.

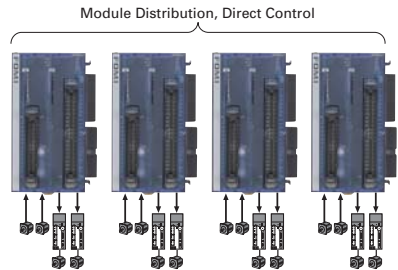

Sync Data Shared between Modules

With the **FQMI**, each Module can broadcast any two types of data as shared data. Data, such as present values of high-speed counters, analog input values, and virtual axes, can be shared between Modules, enabling a wide variety of synchronized control.

•Pulse and Analog I/O Values Can Be Synchronized and Shared

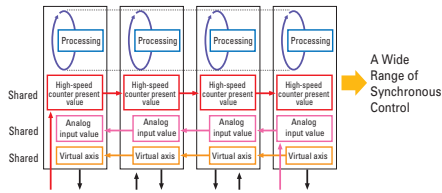

Note: The following types of information can be shared between Modules: Ladder processing results, high-speed counter present values, pulse output present values, analog input values, analog output values, and built-in input values.

Synchronize Up to Eight Axes

With the **FQMI**, each Motion Control Module can control two axes. If you mount four Modules, synchronous control can be performed for up to eight axes.

•Up to Eight Axes Can Be Synchronized (Processing Cycles of All Modules Are Synchronized)

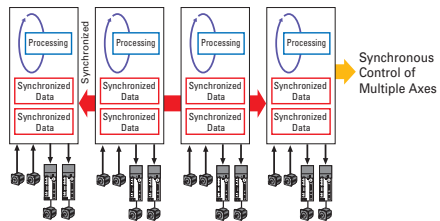

Compatible with Absolute Encoders

A Servo Driver with an absolute encoder can be connected to the **FQMI**.

•Servo Drivers with Absolute Encoders Can Be Used.

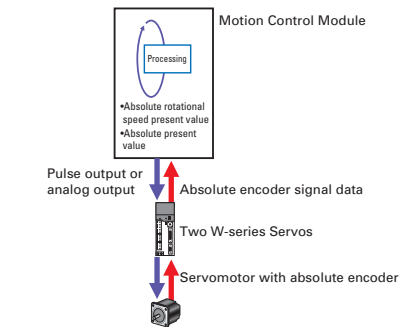

Detailed Programming of Motion Control

With the **FQMI**, each Module contains a user ladder program, enabling programming detailed operations that conventionally could not be implemented by the comparatively conservative processing of specialized motion languages.

•Support for Highly Flexible Programming, such as Control Mode Switching, Operating Condition Changes during Operation, etc.

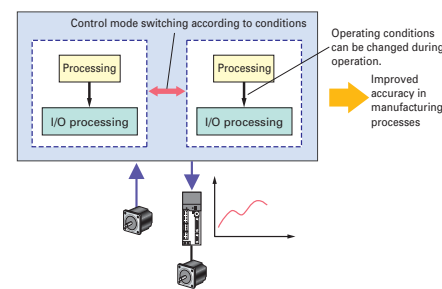

•Ideal Flexible Electronic Cam Operation

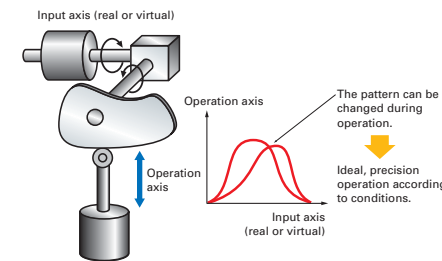

•Tracking Pattern Generation

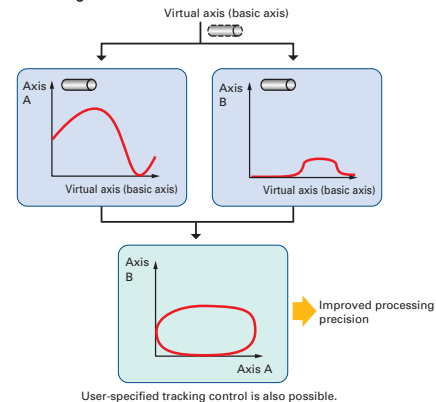

•Generating Ideal Motor Acceleration/Deceleration Patterns

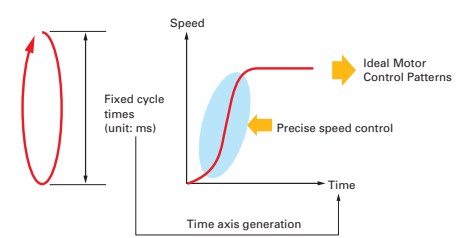

•Operation Switching, such as from Position Control to Speed Control or from Torque Control to Position Control

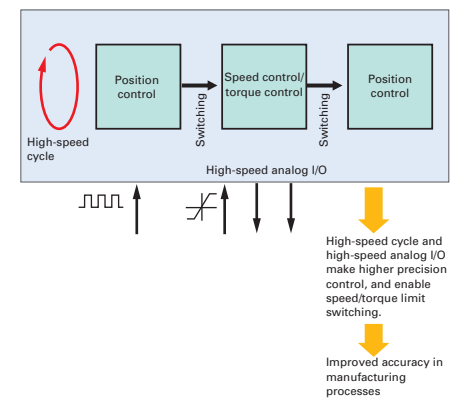

For the Optimal Response Demanded from Your Machines

Quick

Parallel Distributed Processing System

Stable Motion Control Cycles for 2 to 8 Axes

With the FQM1, the Coordinator Module and each Motion Control Module have its own application program (ladder diagram). The Coordinator Module processes communications services with peripherals, such as computers and PTs. This enables each Motion Control Module to concentrate on its processing exclusively, as a closed unit, resulting in high-speed motion control cycles of 0.5 to 2 ms (overhead time in cycle time is 0.19 ms min.). Also, even if the number of control axes increases, control is distributed and executed at each Module so that the same stable motion control cycles can be achieved as for only a few control axes.

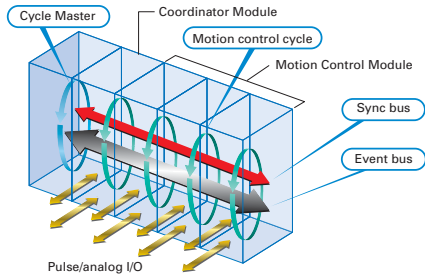

Control Cycles Synced between Axes

The FQM1 has a sync bus running between the Modules so that control can be carried out in the same control cycle (Coordinator Module cycle, or specified cycle time between 0.5 and 10.0 ms) while data, e.g., for virtual axes and real axes, is shared among all Motion Control Modules. By making the control cycle of the Coordinator Module constant, it also becomes possible to make the control cycles of the Motion Control Modules constant.

Control cycles can be synchronized and made constant.

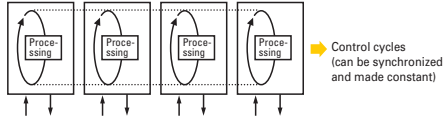

High-speed Processing Performance

High-speed Cyclic Processing Engine Directly Controls Built-in Pulse/Analog I/O

Each FQM1 Motion Control Module has built-in I/O. Therefore each Motion Control Module can perform I/O processing directly as a self-contained unit. Also, the I/O interfaces are designed specifically for speed to enable the following high-speed I/O.

High-speed Pulse Startup

High-speed Pulse Startup at 25 μ s Minimum
 Examples: Electronic cam pulse output: 32 μ s Trapezoidal PTP pulse output: 54 μ s

Input Interrupt

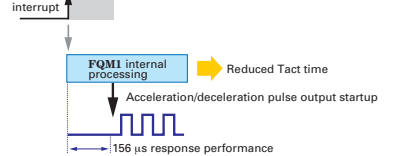

This results in, for example, an interval of 156 μ s between an external input and pulse distribution startup when pulses are output for a PTP operation in response to an input interrupt (using the PLSZ instruction).

High-speed Analog I/O

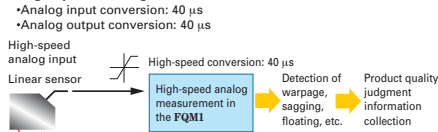

Capturing High-speed Counter Present Value with Hardware Latch

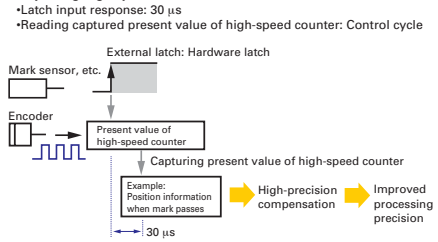

Higher-Frequency Pulse I/O

To support applications demanding high precision, the FQM1 has increased the frequencies for pulse I/O.
 •Pulse input: 500 kHz (phase difference with multiple of 4: 2 MHz)
 •Pulse output: Maximum output frequency of 1 MHz

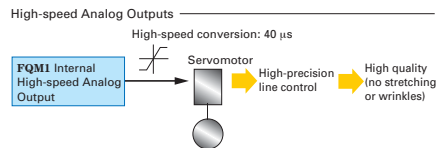
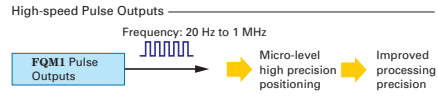
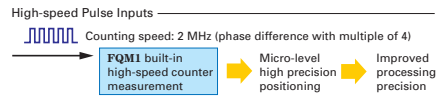

Program Development Environment

Application program development is as easy for the FQM1 as for a PLC.

Connect the CX-Programmer Support Software to the Coordinator Module to create and monitor programs for all Modules. While monitoring the ladder programs in Motion Control Modules, it is possible to input operation conditions for monitoring the I/O of the Coordinator Module, and to debug programs.

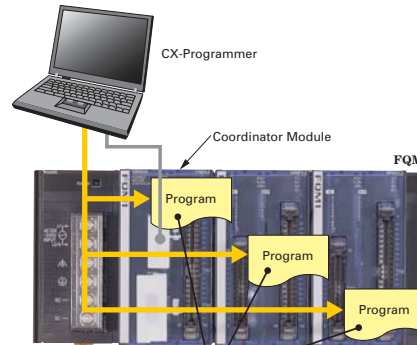

Ladder programs for the Coordinator Module and all Motion Control Modules can be created, transferred, and monitored.

Set the Module Operations on the System Setup Window

System Setup, such as the FQM1 synchronous/asynchronous mode setting, to determine the FQM1 operation modes are required along with creating application programs and can be selected in special windows.

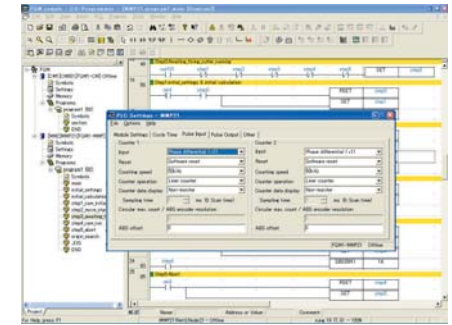

Function Block (Ladder Programming and ST Language) Support Further Improve Development Efficiency and Maintenance.

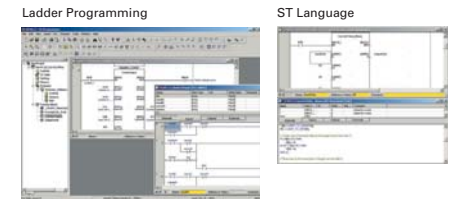

Manage the FQM1 Module Configuration on a Directory Tree on the Support Software.

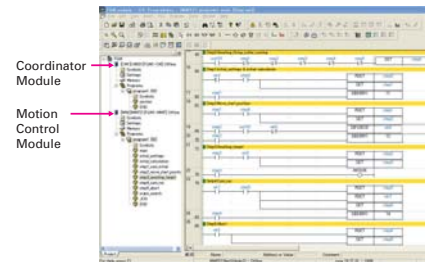

Note: Use CX-Programmer version 6.11 or higher with the FQM1.

Calculation processing can be written with Structured Text

Efficiency of development and maintenance is increased for motion control applications with a lot of calculation processing.



Connecting Peripherals

Serial communications systems can be constructed with the host PC.

- Host Links with CS/CJ-series PLCs
- Serial PLC Links with CJ1M PLCs

Serial Communications with the Host PLC

FQM1 data can be read and written using communications instructions from the host PLC.

Equipped with Host Link Functions as Standard Feature: Coordinator Module

By mounting a Serial Communications Unit (of Unit version 1.2 or later) to a CS/CJ-series PLC, accessed data can be read and written for the FQM1 using the SEND/RECV network communications instructions with the CS/CJ-series PLC as the Host Link master and the FQM1 as the Host Link slave (using the RS-232C port on the Coordinator Module).

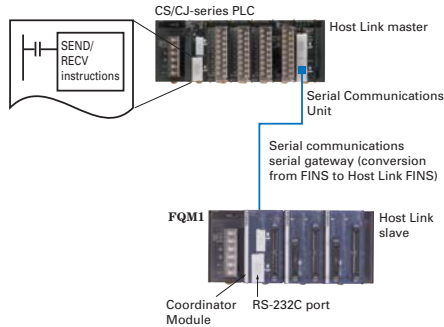

Seamless Data Exchange with Host Controllers

Serial PLC Links Supported

(Data Sharing with the OMRON CJ1M PLC)

Exchange of control data with the machine's main controller (PLC) can be performed without any special programming. With the CJ1M CPU Unit as master and the FQM1 as slave, data can be exchanged between the two without special programming. Connect the FQM1 Coordinator Module to the RS-232C port.

Note 1: The master link method and complete link method for Serial PLC Links are supported.
Note 2: When connecting 1:N (where N = 8 units max.) via RS-422A/485, use an RS-422A converter (CJ1W-CIF11).

The maximum size of each CJ1M/FQM1 transmission is ten words. Transmissions smaller than ten words (unified CJ1M/FQM1 size) can also be sent (set as the number of link words).

System Configuration

•CJ1M:FQM1 = 1:1 Connection

CJ1M CPU Unit (master)

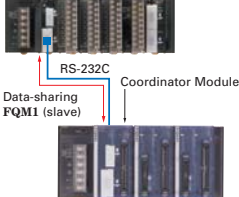

•CJ1M:FQM1 = 1:N (8 Max.) Connection

CJ1M CPU Unit (master)

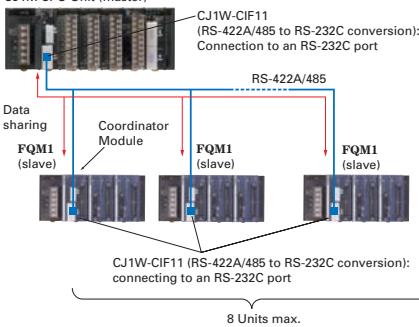

Reference information: In the complete link method, the CJ1M CPU Unit will be the master and data transfer will be possible among the FQM1 slaves.

Connecting Peripherals

Construct Touch Panel (PT) Systems and DeviceNet Systems.

- NS-series PTs supported.
- DeviceNet supported.

Serial Communications with NS-series PTs

Easy Servo Parameter Setup/Monitoring from NS-series PTs

Serial Gateway Function

(Built-in RS-422A for Connecting to Servo)

Servo parameters and other data can be read or written from an NS-series PT or computer (application running on the CX-Server) via the FQM1 Coordinator Module for servo drivers connected by RS-422A. This makes it easy to enter servo driver parameter settings at system startup, and to monitor operation.

- RS-422A-compatible Servo Drivers

OMRON W-series or SMARTSTEP

System Configuration

Example: Accessing a Servo Driver (W-series or SMARTSTEP) Using Smart Active Parts on an NS-series PT Connected Using an NT Link

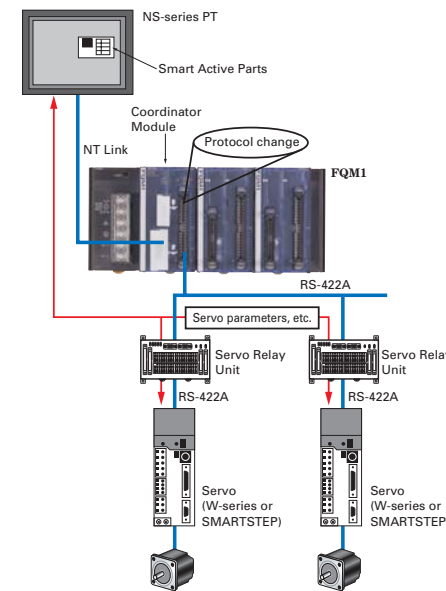

Note: The Servo Relay Unit has a built-in RS-422A connector for connecting to the FQM1.

DeviceNet communications with the host controller

Data can be exchanged with the host controller using DeviceNet without special programming.

Add a DeviceNet Slave Function

Remote I/O communications will be possible between the host controller (master) and FQM1 (slave) if the FQM1 is expanded using an I/O Control Module and the slave function of a CJ-series DeviceNet Unit.

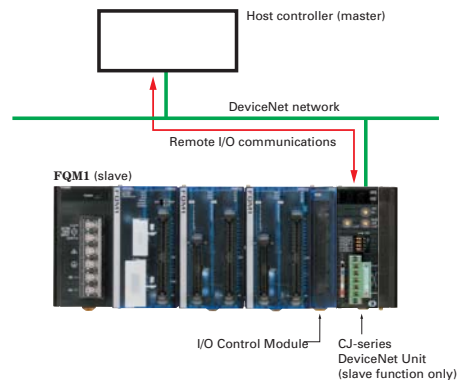

Expansion Possible Using CJ-series Units

Expansion Is Performed through an I/O Control Module
(for Bus Conversion and I/O Expansion)

- CJ-series Basic I/O Units
- CompoBus/S Master Units, DeviceNet Units, Position Control Units, High-speed Data Collection Units
- CJ-series Expansion Rack (The above Units can be mounted; one Rack only.)

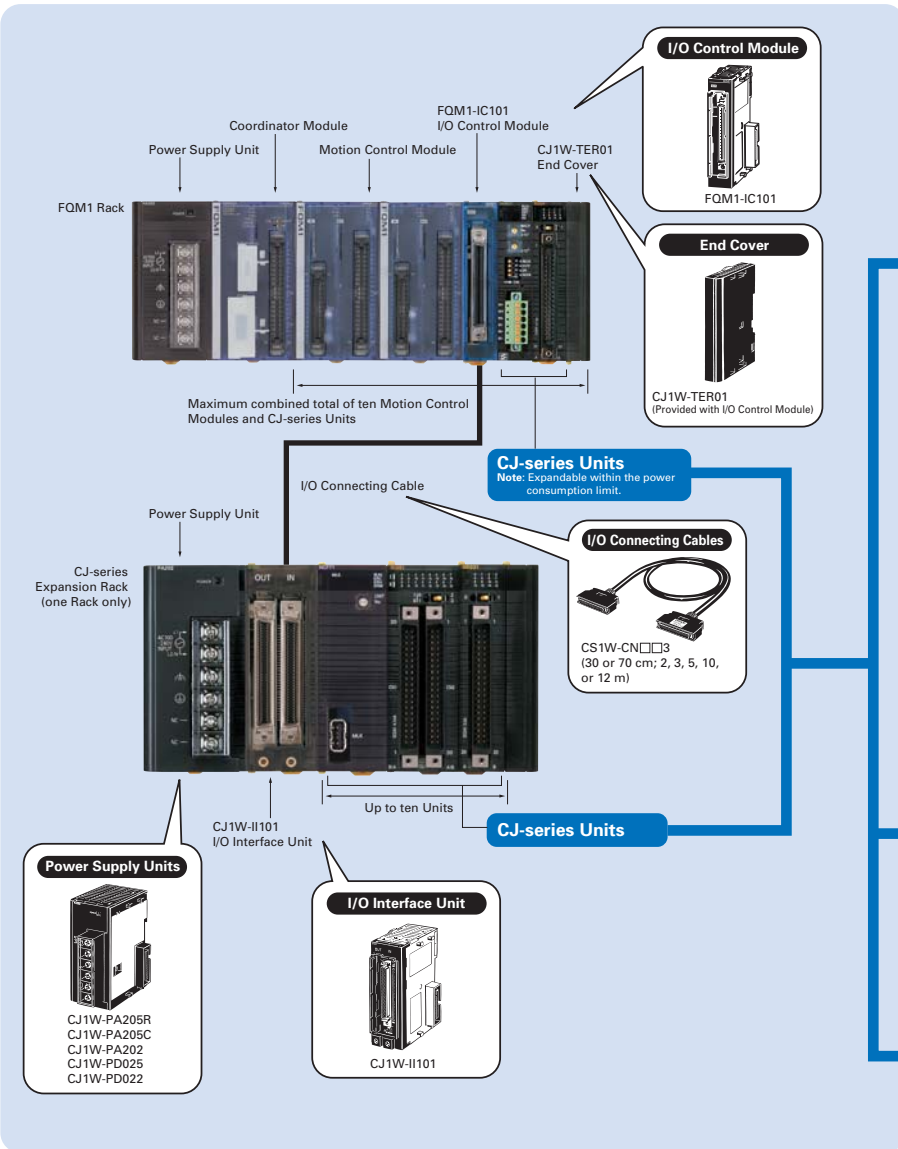

CJ-series Units for FQM1 Expansion

Basic I/O Units

● **Input Units**

16-point DC Input Units CJ1W-ID201/211	32-point DC Input Unit CJ1W-ID231	32-point DC Input Unit CJ1W-ID232	64-point DC Input Unit CJ1W-ID261	64-point DC Input Unit CJ1W-ID262	8 or 16-point AC Input Units CJ1W-IA111/201

● **Output Units**

8-point Transistor Output Units CJ1W-OD20□	16-point Transistor Output Units CJ1W-OD211/212	32-point Transistor Output Unit CJ1W-OD231	32-point Transistor Output Units CJ1W-OD232/233	64-point Transistor Output Unit CJ1W-OD261	64-point Transistor Output Units CJ1W-OD262/263
8-point (Independent) Relay Contact Output Unit CJ1W-OC201	16-point Relay Contact Output Unit CJ1W-OC211	8-point Triac Output Unit CJ1W-OA201			

● **I/O Units**

32-point DC Input/Transistor Output Unit CJ1W-MD231	32-point DC Input/Transistor Output Units CJ1W-MD232/233	64-point DC Input/Transistor Output Unit CJ1W-MD261	64-point DC Input/Transistor Output Unit CJ1W-MD263	64-point TTL I/O Unit CJ1W-MD563	64-point B7A Interface Units CJ1W-B7A□□

Special I/O Units

CompoBus/S Master Unit CJ1W-SRM21

CPU Bus Units

Position Control Unit CJ1W-NCF71 (with MECHATROLINK-II)	DeviceNet Unit CJ1W-DRM21	High-speed Data Collection Unit CJ1W-SPU01

Performance and Specifications

■ General Specifications

Item	Specifications			
	Coordinator Module	Motion Control Module		
Control method	Stored program method	Stored program method		
I/O control method	Cyclic scan method	Cyclic scan method		
Programming language	Ladder diagram method	Ladder diagram method		
Instruction length	1 to 7 steps/instruction	1 to 7 steps/instruction		
Number of instructions	Approx. 300	Approx. 300		
Executing speed	Basic instructions	0.1 μs min.		
	Special instructions	0.3 μs min.		
Common processing time (overhead)	Synchronous mode: 390 μs (when 1 Motion Control Module is connected) Asynchronous mode: 180 μs	FQM1-MMP22 Synchronous mode: 250 μs Asynchronous mode: 190 μs FQM1-MMA22 Synchronous mode: 340 μs Asynchronous mode: 290 μs Analog outputs disabled and immediate analog inputs: 190 μs Analog input END: 230 μs		
	Program capacity	Ladder: 10 Ksteps Comment storage: Yes	10 Ksteps Yes	
Number of tasks	Cyclic tasks: 1, Interrupt tasks: 50	Cyclic tasks: 1, Interrupt tasks: 50		
Subroutines	256	256		
JMP instruction	256	256		
Number of basic I/O points	24	20 per Module		
C/O Area	Built-in Input Bits	16 bits (1 word): CIO 2960.00 to CIO 2960.15	12 bits (1 word): CIO 2960.00 to CIO 2960.11	
	Built-in Output Bits	8 bits (1 word): CIO 2961.00 to CIO 2961.07	8 bits (1 word): CIO 2961.00 to CIO 2961.07	
	I/O bits	320 bits (20 words): CIO 0000 to CIO 0019	None	
	CPU Bus Unit Area	6,400 bits (400 words): CIO 1500 to CIO 1899	None	
	Special I/O Unit Area	13,760 bits (860 words): CIO 2100 to CIO 2959	None	
	Cyclic Refresh Bit Area	640 bits (40 words): CIO 4000 to CIO 4039 Refresh with Motion Module # 1: CIO 4000 to CIO 4009 Refresh with Motion Module # 1: CIO 4010 to CIO 4019 Refresh with Motion Module # 1: CIO 4020 to CIO 4029 Refresh with Motion Module # 1: CIO 4030 to CIO 4039	160 bits (10 words): CIO 4000 to CIO 4009 Input refresh from Coordinator Module to Motion Control Module: CIO 4000 to CIO 4004 Output refresh from Motion Control Module to Coordinator Module: CIO 4005 to CIO 4009	
	Sync Data Link Bit Area	320 bits (20 words): CIO 1200 to CIO 1219 Transmission refresh from Coordinator Module: CIO 1200 to CIO 1203 Transmission refresh from Motion Module # 1: CIO 1204 to CIO 1207 Transmission refresh from Motion Module # 2: CIO 1208 to CIO 1211 Transmission refresh from Motion Module # 3: CIO 1212 to CIO 1215 Transmission refresh from Motion Module # 4: CIO 1216 to CIO 1219	320 bits (20 words): CIO 1200 to CIO 1219 Transmission refresh from Coordinator Module: CIO 1200 to CIO 1203 Transmission refresh from Motion Module # 1: CIO 1204 to CIO 1207 Transmission refresh from Motion Module # 2: CIO 1208 to CIO 1211 Transmission refresh from Motion Module # 3: CIO 1212 to CIO 1215 Transmission refresh from Motion Module # 4: CIO 1216 to CIO 1219	
	Serial PLC Link Bit Area (complete link method)	1,440 bits (90 words) CIO 3100 to CIO 3189 CIO 3100 to CIO 3189: CJ1M to FQM1 CIO 3100 to CIO 3189: FQM1 to CJ1M and sources other than FQM1 (10 words each according to unit number)	None	
	Serial PLC Link Bit Area (master link method)	320 bits (20 words): CIO 3100 to CIO 3119 CIO 3100 to CIO 3109: CJ1M to FQM1 CIO 3110 to CIO 3119: FQM1 to CJ1M Connectable to the host PLC (CJ1M) as a Serial PLC Link slave.	None	
	DeviceNet Link Bit Area	9,600 bits (600 words): CIO 3200 to CIO 3799	None	
	Internal Auxiliary Area	C/O Area	49,792 bits: CIO 0020 to CIO 1199, CIO 1220 to CIO 1499, CIO 1900 to CIO 2099, CIO 2962 to CIO 3099, CIO 3190 to CIO 3199, CIO 3800 to CIO 3999, CIO 4040 to CIO 4999, CIO 6000 to CIO 6143	81,792 bits: CIO 0000 to CIO 1199, CIO 1220 to CIO 2959, CIO 2962 to CIO 3999, CIO 4010 to CIO 4999, CIO 6000 to CIO 6143
		Work Area	4,096 bits: W000 to W255	4,096 bits: W000 to W255

■ Performance Specifications

Item	Specifications		
	Coordinator Module	Motion Control Module	
Auxiliary Area	READ/WRITE	Read-only: 7,168 bits (A000 to A447) Read/Write: 8,192 bits (A448 to A959)	Read-only: 7,168 bits (A000 to A447) Read/Write: 8,192 bits (A448 to A959)
	Error log	100 words: A100 to A199 (20 records)	100 words: A100 to A199 (20 records)
TR Area	16 bits: TR0 to TR15	16 bits: TR0 to TR15	
Timer Area	256 timers: T0000 to T0255 (1-ms timers, 10-ms timers, 100-ms timers)	256 timers: T0000 to T0255 (1-ms timers, 10-ms timers, 100-ms timers)	
Counter Area	256 counters: C0000 to C0255 (decrementing counters, reversible counters) *Not retained on power interruption.	256 counters: C0000 to C0255 (decrementing counters, reversible counters) *Not retained on power interruption.	
DM Area	Read/Write (not retained)	20,000 words: D00000 to D19999 (Not retained on power interruption.)	30,000 words: D00000 to D29999 (Not retained on power interruption.) (See note 1.)
	Read/Write (retained)	12,768 words: D20000 to D32767 (Saved in flash memory. Not saved when written by ladder program, however, saved in flash memory if written by Programming Device such as the CX-Programmer.)	2,768 words: D30000 to D32767 (backed up by super capacitor)
System Setup	System Setup Area (shared by Coordinator Module, Motion Control Modules, and peripheral services), Peripheral Service Settings	System Setup Area (shared by Coordinator Module and Motion Control Modules), Motion Parameter Settings	
Function block address allocation area	C/O Area	16,000 bits (1,000 words): CIO 5000 to CIO 5999	16,000 bits (1,000 words): CIO 5000 to CIO 5999
	Timer Area	100 bits: T0206 to T0255	100 bits: T0206 to T0255
	Counter Area	100 bits: C0206 to C0255	100 bits: C0206 to C0255
Index Registers	IR0 to IR15 (IR0 and IR1 used with the JSB instruction) Note: IR16 to IR 63 for FB/ST (used by the system)	IR0 to IR15 (IR0 and IR1 used with the JSB instruction) Note: IR16 to IR 63 for FB/ST (used by the system)	
Data Registers	DR0 to DR15 Note: IR16 to IR 63 for FB/ST (used by the system)	DR0 to DR15 Note: IR16 to IR 63 for FB/ST (used by the system)	
Interrupts	Input interrupts	None	4 inputs (with countdown mode)
	Timer interrupts	1 (scheduled or one-shot interrupts)	1 (scheduled or one-shot interrupts)
Power OFF backup function (momentary power interruptions)	Super capacitor	Super capacitor	
Memory backup	Super capacitor backup	Error log	Error log, a portion of DM (for momentary interruptions)
	Flash memory	User programs, System Setup, part of DM	User programs, System Setup
Trace Memory	4,000 words	4,000 words	
Peripheral services	Peripheral port (CX-Programmer connection only), RS-232C port (Host Link, no-protocol, NT Link, Serial PLC Link (slave)), RS-422A (servo driver connection) services	Event requests from the Coordinator Module	
Self-diagnosis	CPU error (WDT), memory error	CPU error (WDT), memory error	
Program check functions	Checked using Programming Device	Checked using Programming Device	
Super capacitor life	Approx. 100 hours (ambient temperature: 25°C, see note 2.)	Approx. 100 hours (ambient temperature: 25°C, see note 2.)	
Clock	None	None	
Power interruption detection time	AC: 10 to 25 ms (not fixed)	—	
Power interruption detection delay	0 to 10 ms	—	
RUN output	Yes (When using CJ1W-PA205R)	—	

Note 1: Can also be retained in flash memory. A bit can be manipulated to automatically restore the data according to a parameter setting in the System Setup when the power supply is turned ON.
2: Depends on the ambient temperature and number of years in use.

Performance and Specifications

Item	Specifications		
	Coordinator Module	Motion Control Module	
Individual functions	Serial communications Peripheral port (toolbus, Host Link) Coordinator Module built-in RS-232C port (Host Link, no-protocol, NT Link, Serial PC Link (slave)) Coordinator Module built-in RS-422A port (servo driver interface, serial gateway, no-protocol)	High-speed counters	Single phase, up-down counting, pulse plus direction input (50 kHz/1 MHz), differential phase inputs (50/500 kHz, with phase difference multiplier of 4: 2 MHz)
		High-speed pulse outputs	CW/CCW (1 MHz: line-driver) one-shot pulse output
		Analog inputs	Conversion speed: 40 μs/point Resolution: -10 to 10 V: 16,000 0 to 10 V: 8,000 0 to 5 V: 4,000 1 to 5 V: 4,000 4 to 20 mA: 4,000
		Analog outputs	Conversion speed: 40 μs/point Resolution: -10 to 10 V: 10,000 0 to 10 V, 0 to 5 V, or 1 to 5 V: 4,000

Coordinator Module

Built-in General-purpose I/O

Item	Specifications	
Input specifications	Inputs	16
	Input voltage	20.4 to 26.4 V
	Input voltage	Normal inputs (16): ON response: 100 μs, OFF response: 1 ms max. 8 inputs/common
Output specifications	Outputs	8
	Output form	NPN transistors
	Switching capacity	4.5 to 30 VDC, 0.3 A per transistor
	ON response time	0.1 ms max.
	OFF response time	1 ms max.

Motion Control Module

Built-in General-purpose I/O

Item	Specifications	
Input specifications	Inputs	12
	Input voltage	20.4 to 26.4 V
	Input voltage	Interrupt inputs (4): ON response: 30 μs max. OFF response: 0.2 ms max. Normal inputs (8): ON response: 100 μs max. OFF response: 1 ms max.
Output specifications	Outputs	8
	Output form	NPN transistors
	Switching capacity	4.5 to 30 VDC, 0.3 A per transistor
	Output response	ON response: 0.1 ms max. OFF response: 1 ms max.

Motion Control Module

Built-in General-purpose I/O (FQM1-MMP22)

Item	Description	
I/O	Pulse I/O	Pulse inputs: 2 (for servo with absolute encoder) Pulse outputs: 2 One-shot pulse outputs: 2
	General-purpose I/O	General-purpose inputs: 12 General-purpose outputs: 8
Functions	Pulse outputs	The following operations are possible. • Speed control (fixed speed, acceleration, and deceleration) • Position control (fixed-speed positioning, trapezoidal positioning, deceleration positioning) • Speed control based on present position (pulse output target value comparison or range comparison) • Electronic cam operation (positioning according to position of real or virtual axis) • One-shot pulse outputs (turning ON an output for a specified time, minimum unit: 0.01 ms) • Timing using pulse counter (minimum unit: 0.001 ms)
	Pulse inputs	• High-speed counters: Single phase, up-down counting, pulse plus direction input (50 kHz/1 MHz), differential phase inputs (50/500 kHz, with multiplier of 4: 2 MHz) • Starting/stopping high-speed counters with Counter Start Bit • Measuring change in high-speed counter present value • Measuring high-speed counter frequency

Motion Control Module with Analog I/O (FQM1-MMA22)

Item	Description	
General-purpose I/O	Pulse inputs	Pulse inputs: 2 (for servo with absolute encoder)
	Analog I/O	• Analog inputs: 1 (-10 to 10 V, 0 to 10 V, 0 to 5 V, 1 to 5 V, and 4 to 20 mA), Conversion speed: 40 μs/point • Analog outputs: 2 (-10 to 10 V, 0 to 10 V, 0 to 5 V, and 1 to 5 V), Conversion speed: 40 μs/point
Functions	General-purpose I/O	General-purpose inputs: 12 General-purpose outputs: 8
	Analog outputs	• Slope function • Output hold function • Offset gain adjustment
	Analog inputs	• Offset gain adjustment • High-speed analog sampling

General Specifications

Item	Specifications
Insulation resistance	20 MΩ min. between AC external terminals and GR terminal at 500 VDC, see note 1.)
Dielectric strength	2,300 VAC, 50/60 Hz between AC external terminals and GR terminal for 1 min, leakage current: 10 mA max. (See notes 1 and 3.)
	720 VAC, 50/60 Hz between DC external terminals and GR terminal for 1 min, leakage current: 10 mA max. (See note 1.)
Noise immunity	Conforms to IEC61000-4-4, 2 kV (power line)
Vibration resistance	Conforms to JIS C0040 Amplitude: 0.075 mm (10 to 57 Hz), Acceleration: 9.8 m/s ² (57 to 150 Hz) for 80 min in X, Y, and Z directions (10 sweeps of 8 min = 80 min total)
Shock resistance	Conforms to JIS C0041 147 m/s ² 3 times each in X, Y, and Z directions
Ambient operating temperature	0 to 55°C
Ambient operating humidity	10% to 90% (with no condensation)
Atmosphere	No corrosive gases
Ambient storage temperature	-20 to 75°C
Ground	Less than 100 Ω
Structure	For installation in a control panel
Dimensions (mm)	49 x 90 x 80 mm (W x H x D) excluding cable
Weight	5 kg max. per Module
Safety standards	EC, C-Tick, UL approval pending (See note 4.)

Note 1: Disconnect the LG terminal on the Power Supply Unit from the GR terminal before performing insulation resistance or dielectric testing. Internal components may be destroyed if testing is performed with the LR and GR terminals connected.

Note 2: Values for AC power are at room temperature and a cold start. Values for DC power are for a cold start. A thermistor is used in the inrush current control circuit of the AC power supply to control current at low temperatures. The inrush current may exceed the value given above (by up to twice the given value) when starting at high temperatures or if a hot start is performed immediately after the current is turned OFF for a short period of time because the thermistor element will not be sufficiently cooled. When selecting a fuse or breaker for the external circuit, consider the fusing/detection characteristics and provide a sufficient margin in performance. A capacitor-charged delay circuit is used for the inrush current control circuit in the DC power supply. If hot starts are performed after turning OFF the power supply for only short periods of time, the inrush current may exceed the value given above (by up to twice the given value) because the capacitor will not be discharged.

Note 3: Do not apply voltages exceeding 600 V when performing dielectric testing for the analog I/O terminals. Internal elements may deteriorate.

Note 4: UL-approved products are scheduled for shipment in March 2006.

Combinations of Power Supply Unit and Models

FQM1 without Expansion Using CJ-series Units

No. of axes	No. of FQM1-MMP22 Modules	No. of FQM1-MMA22 Modules	Power Supply Units
2 Axes	1	0	CJ1W-PA202 CJ1W-PA205R
	0	1	
4 Axes	2	0	CJ1W-PA202 CJ1W-PA205R
	1	1	
6 Axes	0	2	CJ1W-PA205R
	3	0	
	2	1	
8 Axes	1	2	Not possible.
	0	3	
	3	1	
	2	2	
	1	3	
	0	4	

Power Supply Unit Specifications

Item	Specifications	
Power Supply Unit model	CJ1W-PA205R	CJ1W-PA202
Power supply voltage	100 to 240 VAC (wide range), 50/60 Hz	
Allowable power supply voltage and frequency ranges	85 to 264 VAC, 47 to 63 Hz	
Power consumption	100 VA max.	50 VA max.
Inrush current (See note 2.)	100 to 120 VAC Input: 15 A max. for 8 ms max. (for cold start at room temperature) 200 to 240 VAC Input: 30 A max. for 8 ms max. (for cold start at room temperature)	100 to 120 VAC Input: 20 A max. for 8 ms max. (for cold start at room temperature) 200 to 240 VAC Input: 40 A max. for 8 ms max. (for cold start at room temperature)
	5.0 A at 5 VDC (including power supplied to Modules) 0.8 A at 24 VDC 25 W total max.	2.8 A at 5 VDC (including power supplied to Modules) 0.4 A at 24 VDC 14 W total max.
Power output terminals	None	
RUN output	Contact structure: STSP-NO Switching capacity: 2 A at 250 VAC (resistive load) 0.5 A at 120 VAC (inductive load) 2 A at 24 VDC (resistive load) 4 A at 24 VDC (inductive load)	None
Insulation resistance	20 MΩ min. between AC external terminals and GR terminal at 500 VDC (See note 1.)	
	2,300 VAC, 50/60 Hz between AC external terminals and GR terminal for 1 min, leakage current: 10 mA max. (See note 1.)	
Dielectric strength	1,000 VAC, 50/60 Hz between DC external terminals and GR terminal for 1 min, leakage current: 10 mA max. (See note 1.)	
	Conforms to IEC61000-4-4, 2 kV (power line)	
Vibration resistance	Conforms to JIS C0040 Amplitude: 0.075 mm (10 to 57 Hz), Acceleration: 9.8 m/s ² (57 to 150 Hz) for 80 min in X, Y, and Z directions (10 sweeps of 8 min = 80 min total)	
Shock resistance	Conforms to JIS C0041 147 m/s ² 3 times each in X, Y, and Z directions	
Ambient operating temperature	0 to 55°C	
Ambient operating humidity	0% to 90% (with no condensation)	
Atmosphere	No corrosive gases	
Ambient storage temperature	-20 to 75°C	
Ground	Less than 100 Ω	
Structure	For installation in a control panel	
Weight	5 kg max. per Module	
Dimensions (mm)	80 x 90 x 65 mm (W x H x D) excluding cable	45 x 90 x 65 mm (W x H x D) excluding cable
Safety standards	cULus, EC directives	

Dimensions Unit: mm

Coordinator Module FQM1-CM002

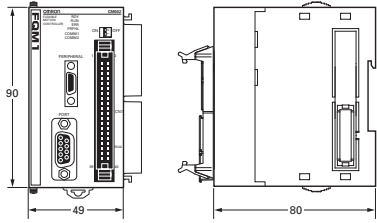

Power Supply Units CJ1W-PA202

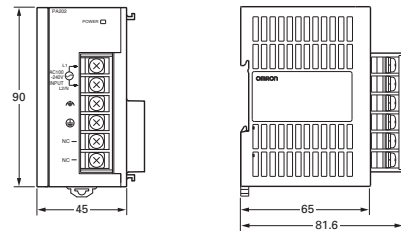

Motion Control Modules FQM1-MMP22/MMA22

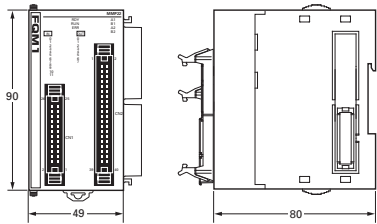

Power Supply Units CJ1W-PA205R

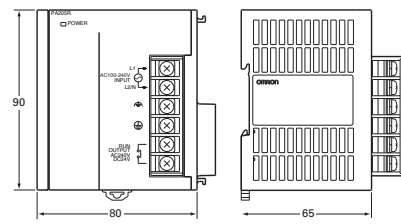

End Module FQM1-TER01

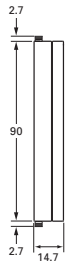

I/O Control Module FQM1-IC101

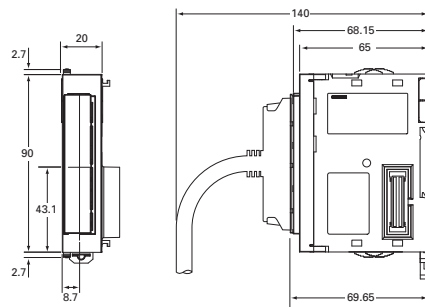

Assembled Dimensions

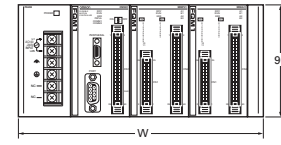

W = a + 49 + 49 × n + 14.7
a: Width of Power Supply Unit
n: Number of Motion Control Modules connected (4 max.)

FQM1 Expanded Using CJ-series Units

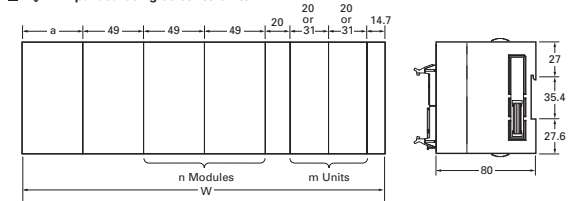

W = a + 49 + 49 × n + (20 or 31) × m + 14.7
a: Width of Power Supply Unit
n: Number of Motion Control Modules connected (4 max.)
m: Number of CJ-series connected
The maximum value of m + n is 10, as long as the current consumption limit is not exceeded.

Height with Cables Connected Height with Peripheral Port and RS-232C Port Connected

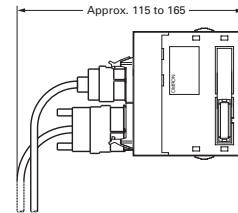

Servo Relay Unit XW2B-80J7-1A

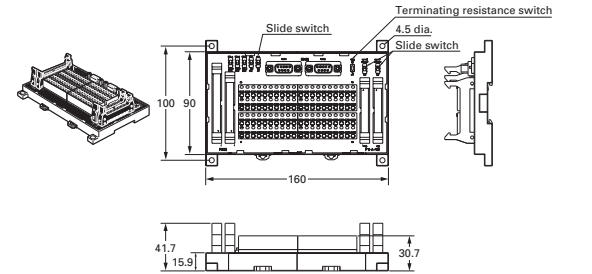

Ordering Information

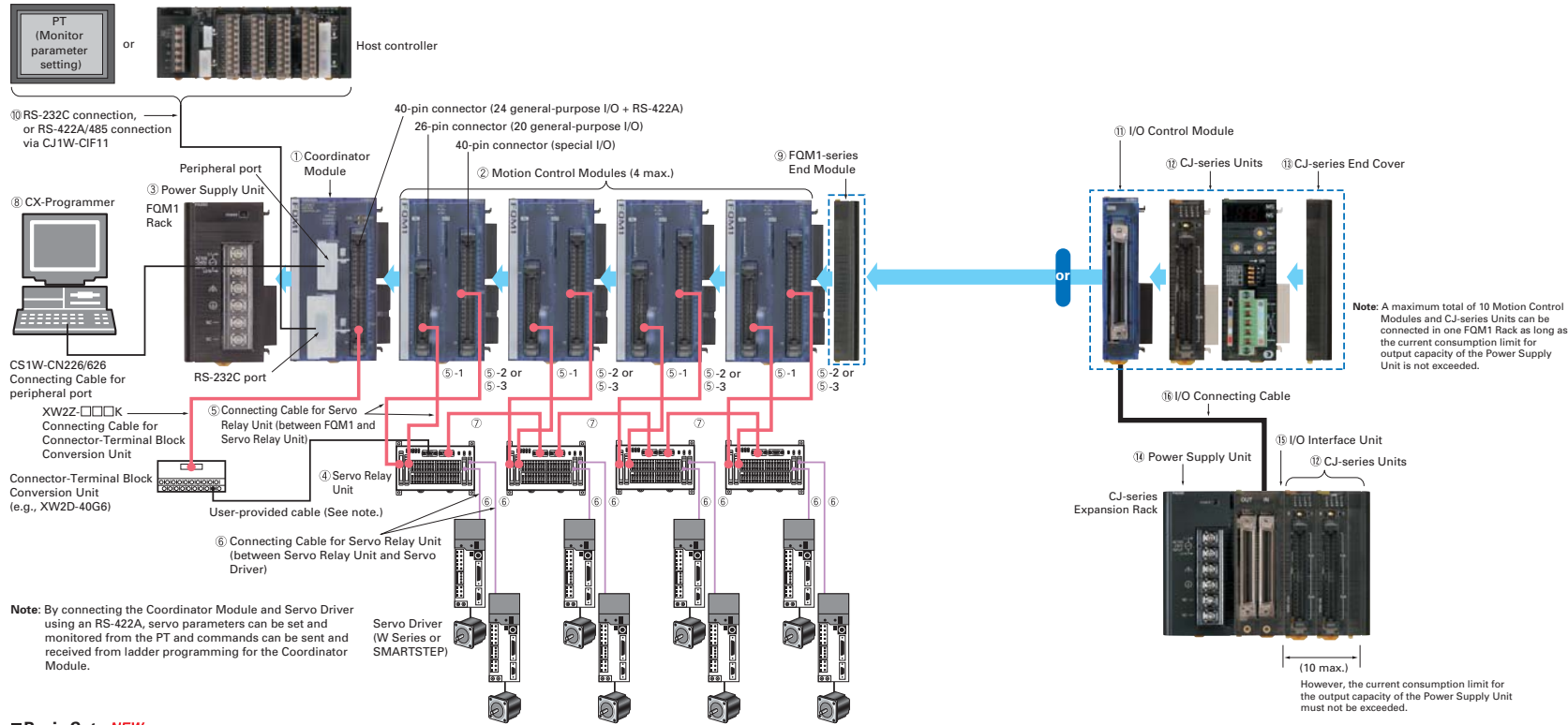

Basic Sets **NEW**

Name	Specifications	Model	Standards
FQM1 Pulse Set	A basic set for pulse outputs and 2 axes ③ CJ1W-PA202 + ① FQM1-CM002 + ② FQM1-MMP22 + ④ FQM1-TER01	FQM1S-MC233 (See note 1.)	CE, UL approval pending (See note 2.)
FQM1 Analog Set	A basic set for analog outputs and 2 axes ③ CJ1W-PA205R + ① FQM1-CM002 + ② FQM1-MMA22 + ④ FQM1-TER01	FQM1S-MC224 (See note 1.)	CE, UL approval pending (See note 2.)

Note 1: The I/O Control Module (FQM1-IC101) is not included.
Note 2: UL-approved products are scheduled for shipment in March 2006.

Basic Modules **NEW**

No. in diagram	Name	Specifications	Current consumption (A)		Model	Standards
			5 V	24 V		
①	Coordinator Module	Program capacity: 10 Ksteps, DM Area capacity: 32 Kwords, Built-in I/O (16 inputs and 8 outputs), I/O Area for CJ-series Basic I/O Unit: 320 bits, Serial PLC Link Area: 1,440 bits, DeviceNet Area: 9,600 bits, Built-in peripheral port, RS-232C port, and RS-422 port	0.37	—	FQM1-CM002 (See note 1.)	CE, UL approval pending (See note 2.)
②	Motion Control Modules	Program capacity: 10 Ksteps, DM Area capacity: 32 Kwords, Built-in I/O: 12 inputs and 8 outputs, two pulse inputs, two pulse outputs	0.824	—	FQM1-MMP22	CE, UL approval pending (See note 2.)
		Program capacity: 10 Ksteps, DM Area capacity: 32 Kwords, Built-in I/O (12 inputs and 8 outputs), 2 pulse inputs, 1 analog input, 2 analog outputs	0.772	0.095	FQM1-MMA22	CE, UL approval pending (See note 2.)
③	Power Supply Unit	100 to 240 VAC, output capacity: 2.8 A at 5 VDC, 0.4 A at 24 VDC, total power consumption: 14 W			CJ1W-PA202	UC1, CE, N, L
		100 to 240 VAC (with RUN output), output capacity: 5 A at 5 VDC, 0.8 A at 24 VDC, total power consumption: 25 W			CJ1W-PA205R	
		100 to 240 VAC, replacement time notification function, no RUN output, Output capacity: 5 A at 5 VDC, 0.8 A at 24 VDC, total power consumption: 25 W			CJ1W-PA205C	

Note 1: A FQM1-TER01 End Module is included.
Note 2: UL-approved products are scheduled for shipment in March 2006.

Servo Relay Unit and Cables

No. in diagram	Name	Specifications	Model	Standards	
④	Servo Relay Unit	FQM1-series Servo Relay Unit with 2 axis connections	XW2B-80J7-1A	UC1	
⑤	Connecting Cable for Servo Relay Unit (between FQM1 and Servo Relay Unit)	⑤-1 For connecting 26-pin connector on FQM1-MM□22 to Servo Relay Unit	Cable length: 0.5 m Cable length: 1 m	XW2Z-050J-A28 XW2Z-100J-A28	UC1 UC1
		⑤-2 For connecting 40-pin connector on FQM1-MMP22 to Servo Relay Unit	Cable length: 0.5 m Cable length: 1 m	XW2Z-050J-A30 XW2Z-100J-A30	UC1 UC1
		⑤-3 For connecting 40-pin connector on FQM1-MMA22 to Servo Relay Unit	Cable length: 0.5 m Cable length: 1 m	XW2Z-050J-A31 XW2Z-100J-A31	UC1 UC1
⑥	Connecting Cable for Servo Relay Unit (between Servo Relay Unit and Servo Driver)	FQM1-MMP22 connection For connecting Servo Relay Unit to W-series Servo Driver	Cable length: 1 m Cable length: 2 m	XW2Z-100J-B9 XW2Z-200J-B9	— —
		FQM1-MMA22 connection For connecting Servo Relay Unit to SMARTSTEP	Cable length: 0.5 m Cable length: 2 m	XW2Z-050J-B10 XW2Z-200J-B10	— —
⑦	RS-422A Communications Cable between Servo Relay Units	FQM1-MMP22 connection For connecting Servo Relay Unit to W-series Servo Driver	Cable length: 1 m Cable length: 2 m	XW2Z-100J-B13 XW2Z-200J-B13	— —
			Cable length: 1 m Cable length: 2 m	XW2Z-100J-C1 XW2Z-200J-C1	— —

Support Software

No. in diagram	Name	Specifications	Model	Standards
⑧	FA Integrated Tool Package CX-One version 1.1	The CX-One is an integrated tool package that provides programming and monitoring software for OMRON PLCs and components. The CX-One runs on any of the following operating systems: Windows 98 SE, Me, NT 4.0 (Service Pack 6), 2000 (Service Pack 3 or higher), or XP. CX-One includes CX-Programmer version 6.□. Refer to the CX-One Catalog (R134) for details.	1 license CXONE-AL01C-E	—
		3 licenses CXONE-AL03C-E	—	
		10 licenses CXONE-AL10C-E	—	
		30 licenses CXONE-AL30C-E	—	
		50 licenses CXONE-AL50C-E	—	
	As previously, the CX-Programmer can also be ordered individually using the following model numbers.			
	CX-Programmer Ver.6.11 or higher	Support Software for PLC programming on Windows 98SE, Me, NT 4.0 (Service Pack 6), 2000 (Service Pack 3 or higher), or XP	1 license WS02-CXPC1-E-V6□	—
3 licenses WS02-CXPC1-E03-V6□		—		
10 licenses WS02-CXPC1-E10-V6□		—		

Site licenses are also available for users that need to use the CX-One on many computers. Ask your OMRON representative for details.

Others

No. in diagram	Name	Specifications	Model	Standards
⑨	End Module	Connected to the right end of the FQM1 Rack. Provided with the FQM1 Sets and with the FQM1-CM002 .	FQM1-TER01	UC1, CE
	DIN Track	Track length: 0.5 m, Height: 7.3 mm	PPF-50N	—
		Track length: 1 m, Height: 7.3 mm	PPF-100N	—
		Track length: 1 m, Height: 16 mm	PPF-100N2	—
	End Plate	Placed on both ends of the Controller on the DIN Track to hold the Controller in place. Two End Plates are provided with the FQM1 Sets and with the FQM1-CM002 .	PPF-M	—
⑩	RS-422A Adapter	Converts RS-232C to RS-422A/485.	CJ1W-CIF11	UC, CE, N

Expansion Using CJ-series Units

No. in diagram	Name	Specifications	Current consumption (A)		Model	Mountable Racks		Standards	
			5 V	24 V		FQM1 Rack	Expansion Rack		
⑪	I/O Control Module	Used when CJ-series Units are connected to the FQM1 . A CJ-series Expansion Rack can be connected at the same time.	0.02	—	FQM1-IC101 (See note 1.)	○	×	UL approval pending (See note 4), CE	
⑫	Input Units	DC Input Units	Terminal block, 12 to 24 VDC, 10 mA, 8 inputs	0.09	—	CJ1W-ID201	○	○	UC, CE, N, L
			Terminal block, 24 VDC, 7 mA, 16 inputs	0.08	—	CJ1W-ID211			
			Fujitsu connector, 24 VDC, 4.1 mA, 32 inputs	0.09	—	CJ1W-ID231 (See note 2.)			
			MIL connector, 24 VDC, 4.1 mA, 32 inputs	0.09	—	CJ1W-ID232 (See note 2.)			
			Fujitsu connector, 24 VDC, 4.1 mA, 64 inputs	0.09	—	CJ1W-ID261 (See note 2.)			
			MIL connector, 24 VDC, 4.1 mA, 64 inputs	0.09	—	CJ1W-ID262 (See note 2.)			
	Input Units	AC Input Units	Terminal block, 100 to 120 VAC, 7 mA (100 V, 50 Hz), 16 inputs	0.09	—	CJ1W-IA111			
			Terminal block, 200 to 240 VAC, 10 mA (200 V, 50 Hz), 8 inputs	0.08	—	CJ1W-IA201			

CJ-series Unit Expansion

No. in diagram	Name	Specifications	Current consumption (A)		Model	Mountable Racks		Standards	
			5 V	24 V		FQM1 Rack	Expansion Rack		
⑬	Relay Output Units	Terminal block, 250 VAC, 24 VDC max., 2 A, 8 outputs, independent contacts	0.09	0.048 (0.006 x number of points ON)	CJ1W-OC201	○	○	UC1, CE, N, L	
		Terminal block, 250 VAC, 24 VDC max., 2 A, 16 outputs, independent contacts	0.11	0.096 (0.006 x number of points ON)	CJ1W-OC211				
	Transistor Output Units	Terminal block, 12 to 24 VDC, 2 A, 8 sinking outputs	0.08	—	CJ1W-OD201				
		Terminal block, 24 VDC, 2 A, 8 sourcing outputs, load short-circuit protection, wiring disconnect detection, and alarm function	0.11	—	CJ1W-OD202				
		Terminal block, 12 to 24 VDC, 0.5 A, 8 sinking outputs	0.10	—	CJ1W-OD203				
		Terminal block, 24 VDC, 0.5 A, 8 sourcing outputs, with load short-circuit protection and alarm function	0.10	—	CJ1W-OD204				
		Terminal block, 12 to 24 VDC, 0.5 A, 16 sinking outputs	0.10	—	CJ1W-OD211				
		Terminal block, 24 VDC, 0.5 A, 16 sourcing outputs, load short-circuit protection and alarm function	0.10	—	CJ1W-OD212				
		Fujitsu connector, 12 to 24 VDC, 0.5 A, 32 sinking outputs	0.14	—	CJ1W-OD231 (See note 2.)				
		MIL connector, 12 to 24 VDC, 0.5 A, 32 sourcing outputs, load short-circuit protection and alarm function	0.15	—	CJ1W-OD232 (See note 2.)				
		MIL connector, 12 to 24 VDC, 0.5 A, 32 sinking outputs	0.14	—	CJ1W-OD233 (See note 2.)				
		Fujitsu connector, 12 to 24 VDC, 0.3 A, 64 sinking outputs	0.17	—	CJ1W-OD261 (See note 2.)				
	Triac Output Unit	Terminal block, 250 VAC, 0.6 A, 8 outputs	0.22	—	CJ1W-OA201				
		DC Input/ Transistor Output Units	24 VDC, 7 mA, 16 inputs	Fujitsu connector	0.13				—
	12 to 24 VDC, 0.5 A, 16 sinking outputs								
	24 VDC, 7 mA, 16 inputs		MIL connector	0.13	—				CJ1W-MD232 (See note 3.)
	24 VDC, 0.5 A, 16 sourcing outputs, load short-circuit protection and alarm function								
	24 VDC, 4.1 mA, 16 inputs		MIL connector	0.13	—				CJ1W-MD233 (See note 3.)
	12 to 24 VDC, 0.5 A, 16 sinking outputs								
	12 to 24 VDC, 0.3 A, 32 sinking outputs		Fujitsu connector	0.14	—				CJ1W-MD261 (See note 2.)
24 VDC, 4.1 mA, 32 inputs									
12 to 24 VDC, 0.3 A, 32 sinking outputs	MIL connector		0.14	—	CJ1W-MD263 (See note 2.)				
24 VDC, 4.1 mA, 32 inputs									
TTL I/O Unit	5 VDC, 3.5 mA, 32 inputs	MIL connector	0.19	—	CJ1W-MD563 (See note 2.)				
	5 VDC, 3.5 mA, 32 outputs								
B7A Interface Unit	64 inputs	0.07	—	CJ1W-B7A14					
	64 outputs	0.07	—	CJ1W-B7A04					
	32 inputs/32 outputs	0.07	—	CJ1W-B7A22					

Note 1: The CJ-series End Cover (CJ1W-TER01) is included.

Note 2: Connectors are not included with the Unit.

Either separately purchase an applicable 40-pole connector, or use an OMRON Connector Terminal Block Conversion Unit (XW2□ series) or a G7□ series I/O Block.

Note 3: Connectors are not included with the Unit.

Either separately purchase an applicable 20- or 24-pole connector, or use an OMRON Connector Terminal Block Conversion Unit (XW2□ series) or a G7□ series I/O Block.

Note 4: UL-approved products are scheduled for shipment in March 2006.

■ CJ-series Unit Expansion

No. in diagram	Name		Specifications	Current consumption (A)		Model	Mountable Racks		Standards
				5 V	24 V		FQM1 Rack	Expansion Rack	
⑫	CJ-series Special I/O Units	CompoBus/S Master Units	Communications functions: Remote I/O communications, maximum number of I/O points per master: 256 (128 inputs, 128 outputs)	0.15	—	CJ1W-SRM21	○	○	UC1, CE, N, L
			Communications functions: Remote I/O communications, maximum number of I/O points per master: 128 (64 inputs, 64 outputs)						
	CJ-series CPU Bus Units	DeviceNet Unit	Provides DeviceNet remote I/O communications (Slave functions only) for 3,200 bits max. (with fixed or user-ser allocation).	0.29	—	CJ1W-DRM21	○	○	UC1, CE, N, L
			Position Control Unit with MECHATROLINK-II communications						
		High-speed Data Collection Unit	Automatically collects the specified data through the CJ bus at intervals of a few ms.	0.56	—	CJ1W-SPU01	○	○	U, CE
⑬	CJ-series End Cover		Mounted on the right end when CJ-series Units are used for expansion.	—	—	CJ1W-TER01	○	○	UC1, CE, N, L
⑭	CJ-series Power Supply Units		100 to 240 VAC, output capacity: 2.8 A at 5 VDC, 0.4 A at 24 VDC, total power consumption: 14 W			CJ1W-PA202			UC1, N, L
			100 to 240 VAC (with RUN output), output capacity: 5 A at 5 VDC, 0.8 A at 24 VDC, total power consumption: 25 W			CJ1W-PA205R			UC1, N, L
			100 to 240 VAC, replacement time notification function, no RUN output, Output capacity: 5A at 5 VDC, 0.8 A at 24 VDC, total power consumption: 25 W			CJ1W-PA205C			UC1, CE, N, L
			24 VDC, output capacity: 5 A at 5 VDC, 0.8 A at 24 VDC, total power consumption: 25 W			CJ1W-PD025			UC1, CE, N, L
		24 VDC, output capacity: 2 A at 5 VDC, 0.4 A at 24 VDC, total power consumption: 19.6 W			CJ1W-PD022			UC1, CE	
⑮	CJ-series I/O Interface Unit		One Unit required on the CJ-series Expansion Rack to connect CJ-series Expansion Rack.	0.13	—	CJ1W-II101			UC1, CE, N, L
⑯	CJ-series I/O Connecting Cables		Connects I/O Control Module on FQM1 Rack to I/O Interface Unit on CJ-series Expansion Rack	Cable length: 0.3 m	—	CS1W-CN313			L, CE
				Cable length: 0.7 m	—	CS1W-CN713			
				Cable length: 2 m	—	CS1W-CN223			
				Cable length: 3 m	—	CS1W-CN323			
				Cable length: 5 m	—	CS1W-CN523			
				Cable length: 10 m	—	CS1W-CN133			
				Cable length: 12 m	—	CS1W-CN133-B2			

Read and Understand this Catalog

Please read and understand this catalog before purchasing the product. Please consult your OMRON representative if you have any questions or comments.

Warranty and Limitations of Liability

WARRANTY

OMRON's exclusive warranty is that the products are free from defects in materials and workmanship for a period of one year (or other period if specified) from date of sale by OMRON.

OMRON MAKES NO WARRANTY OR REPRESENTATION, EXPRESS OR IMPLIED, REGARDING NON-INFRINGEMENT, MERCHANTABILITY, OR FITNESS FOR PARTICULAR PURPOSE OF THE PRODUCTS. ANY BUYER OR USER ACKNOWLEDGES THAT THE BUYER OR USER ALONE HAS DETERMINED THAT THE PRODUCTS WILL SUITABLY MEET THE REQUIREMENTS OF THEIR INTENDED USE. OMRON DISCLAIMS ALL OTHER WARRANTIES, EXPRESS OR IMPLIED.

LIMITATIONS OF LIABILITY

OMRON SHALL NOT BE RESPONSIBLE FOR SPECIAL, INDIRECT, OR CONSEQUENTIAL DAMAGES, LOSS OF PROFITS OR COMMERCIAL LOSS IN ANY WAY CONNECTED WITH THE PRODUCTS, WHETHER SUCH CLAIM IS BASED ON CONTRACT, WARRANTY, NEGLIGENCE, OR STRICT LIABILITY.

In no event shall the responsibility of OMRON for any act exceed the individual price of the product on which liability is asserted.

IN NO EVENT SHALL OMRON BE RESPONSIBLE FOR WARRANTY, REPAIR, OR OTHER CLAIMS REGARDING THE PRODUCTS UNLESS OMRON'S ANALYSIS CONFIRMS THAT THE PRODUCTS WERE PROPERLY HANDLED, STORED, INSTALLED, AND MAINTAINED AND NOT SUBJECT TO CONTAMINATION, ABUSE, MISUSE, OR INAPPROPRIATE MODIFICATION OR REPAIR.

Application Considerations

SUITABILITY FOR USE

OMRON shall not be responsible for conformity with any standards, codes, or regulations that apply to the combination of the product in the customer's application or use of the product.

Take all necessary steps to determine the suitability of the product for the systems, machines, and equipment with which it will be used.

Know and observe all prohibitions of use applicable to this product.

NEVER USE THE PRODUCT FOR AN APPLICATION INVOLVING SERIOUS RISK TO LIFE OR PROPERTY WITHOUT ENSURING THAT THE SYSTEM AS A WHOLE HAS BEEN DESIGNED TO ADDRESS THE RISKS, AND THAT THE OMRON PRODUCT IS PROPERLY RATED AND INSTALLED FOR THE INTENDED USE WITHIN THE OVERALL EQUIPMENT OR SYSTEM.

PROGRAMMABLE PRODUCTS

OMRON shall not be responsible for the user's programming of a programmable product, or any consequence thereof.

Disclaimers

CHANGE IN SPECIFICATIONS

Product specifications and accessories may be changed at any time based on improvements and other reasons. Consult with your OMRON representative at any time to confirm actual specifications of purchased product.

DIMENSIONS AND WEIGHTS

Dimensions and weights are nominal and are not to be used for manufacturing purposes, even when tolerances are shown.

PERFORMANCE DATA

Performance data given in this catalog is provided as a guide for the user in determining suitability and does not constitute a warranty. It may represent the result of OMRON's test conditions, and the users must correlate it to actual application requirements. Actual performance is subject to the OMRON Warranty and Limitations of Liability.