



Chipsmall Limited consists of a professional team with an average of over 10 year of expertise in the distribution of electronic components. Based in Hongkong, we have already established firm and mutual-benefit business relationships with customers from,Europe,America and south Asia,supplying obsolete and hard-to-find components to meet their specific needs.

With the principle of “Quality Parts,Customers Priority,Honest Operation,and Considerate Service”,our business mainly focus on the distribution of electronic components. Line cards we deal with include Microchip,ALPS,ROHM,Xilinx,Pulse,ON,Everlight and Freescale. Main products comprise IC,Modules,Potentiometer,IC Socket,Relay,Connector.Our parts cover such applications as commercial,industrial, and automotives areas.

We are looking forward to setting up business relationship with you and hope to provide you with the best service and solution. Let us make a better world for our industry!



## Contact us

Tel: +86-755-8981 8866 Fax: +86-755-8427 6832

Email & Skype: info@chipsmall.com Web: www.chipsmall.com

Address: A1208, Overseas Decoration Building, #122 Zhenhua RD., Futian, Shenzhen, China



# XW4H/XW4K/XW4L

PCB Terminal Blocks: Push-in SMT Terminals with 2.54mm Pitch

## Push-in Terminals to Easily Complete Connections. PCB Terminal Blocks with 2.54mm Pitch.

- Push-in connection method allows repeated repairs.
- Hold-down structure for strength on PCBs.
- Active lock mechanism for superior vibration and shock resistance.
- Both vertical and horizontal models available.
- Suction cover included to enable automatic mounting. (XW4K/XW4L vertical models)
- Can be mounted to the back surfaces of PCBs.
- Small reel are available. (XW4K/XW4L only)

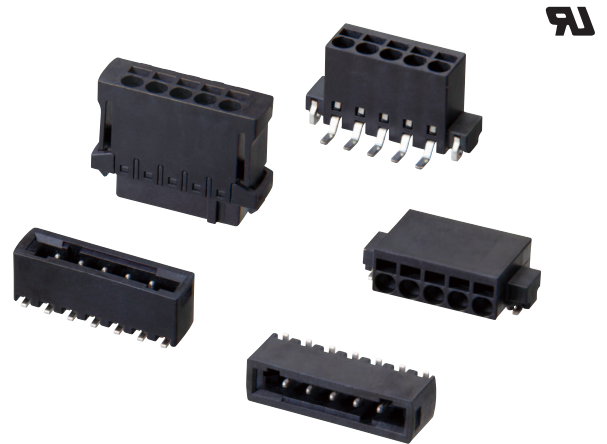

## Features

- Just insert solid wires or ferrules to complete wiring. With Stranded wires, all you need is a flat-blade screwdriver.

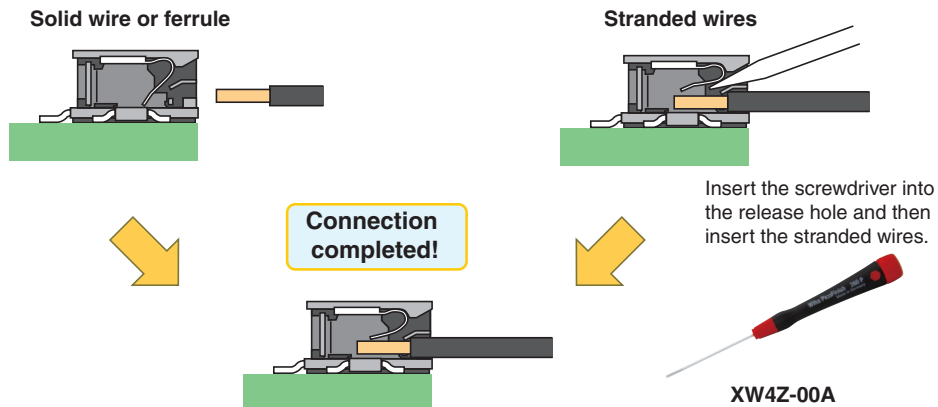

- Hold-downs are provided on both ends to achieve robust mounting by increasing solder mounting strength.
  - The hold-downs are circled in red.

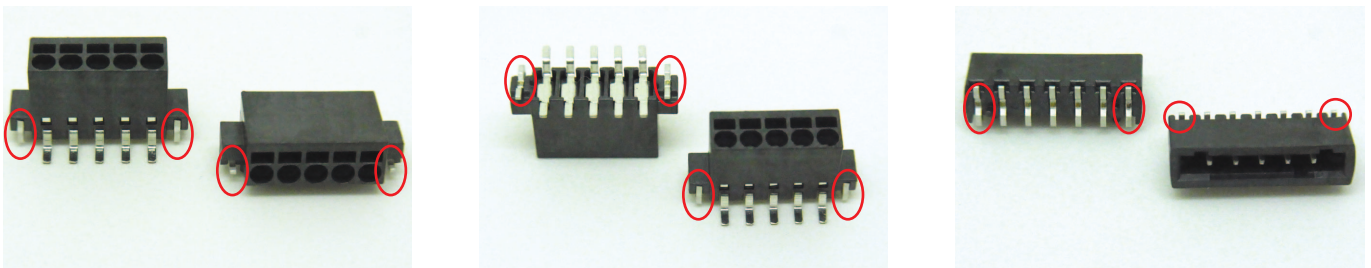

- An active lock mechanism prevents the Terminal Blocks from coming off to provide superior vibration and shock resistance.

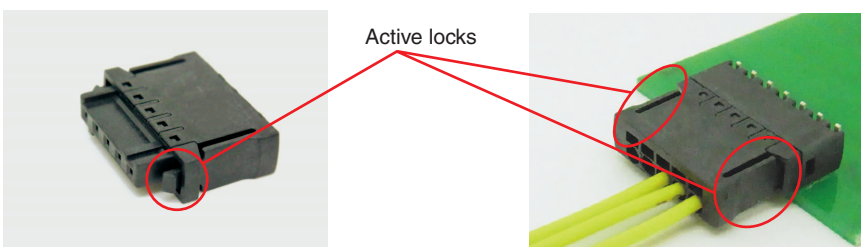



# XW4H/XW4K/XW4L

## Connection Examples

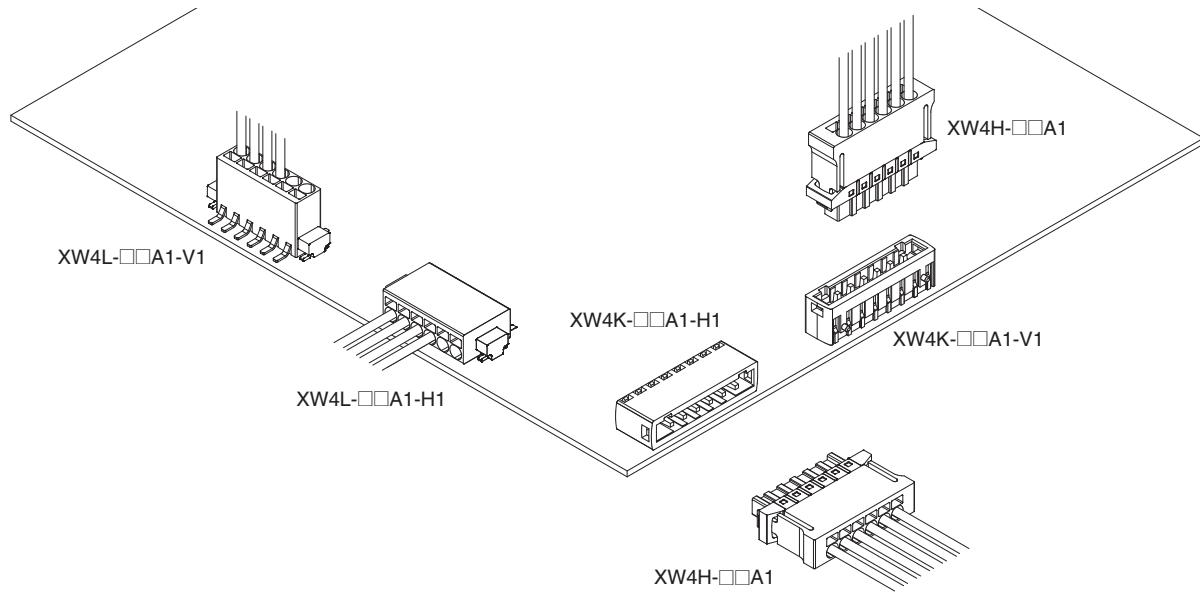

## Model Number Legend

XW4   -     A 1 -     -  

(1) (2) (3) (4) (5) (6)

(1)Series

Code	Type
H	SMT Terminal Block Connector, Wire Side
K	SMT Terminal Block Connector, Board Side
L	SMT Terminal Block Direct Board Mounting

(2)Terminal Block Number of Contacts

Code	Number of contacts
02	2 contacts
03	3 contacts
04	4 contacts
05	5 contacts
06	6 contacts
07	7 contacts
08	8 contacts
09	9 contacts
10	10 contacts
11	11 contacts
12	12 contacts

(3)Terminal Pitch

Code	Pitch
A	2.54mm

(4)Number of Rows and Specifications

Code	Number of rows
1	1 row

(5)Connector Shape \*





Code	Appearance
H1	Horizontal
V1	Vertical

(6)Small reel \*

Code	Quantity
R100	100 pcs

\* XW4K/XW4L only.

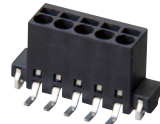
## Terminal Blocks

Models	XW4H-□□A1	XW4K-□□A1-V1	XW4K-□□A1-H1
Appearance	Connector, Wire-side Sockets 	Connector, Board-side Vertical Plugs 	Connector, Board-side Horizontal Plugs 
Page	Page 4	Page 5	Page 5
Models	XW4L-□□A1-V1		XW4L-□□A1-H1
Appearance	Direct-board-mounting, Vertical Sockets 		Direct-board-mounting, Horizontal Sockets 
Page	Page 6		Page 6

Note: □□ is replaced by the number of contacts.

## Ratings and Specifications

<b>Rated voltage</b>	160 VAC
<b>Rated current *</b>	6 A
<b>Dielectric strength</b>	1,400 V for 1 min
<b>Insulation resistance</b>	1,000 M $\Omega$ min.
<b>Wire stripping length</b>	6 mm
<b>Operating temperature</b>	-40 to 125°C (with no condensation or icing)

\* This is the maximum value for the connector.  
If the rated current of the cable is lower than the rated current of the connector, use the rated current of the cable.

## Materials and Finishes

<b>Housing</b>	LCP/Black
<b>Contacts</b>	Copper alloy/tin plated
<b>Spring</b>	SUS

## Applicable Wires

<b>Solid wires</b>	0.14 to 0.5 mm <sup>2</sup>
<b>Stranded wires</b>	0.2 to 0.5 mm <sup>2</sup>
<b>Ferrules</b>	0.25 to 0.34 mm <sup>2</sup>
<b>AWG</b>	26 to 20

# XW4H/XW4K/XW4L

## XW4H Connectors, Wire Side

### Dimensions

(Unit: mm)

XW4H-□□A1

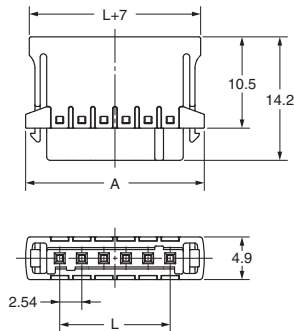

### Dimensions

Models	Number of contacts	L	A
XW4H-02A1	2	2.54	10.38
XW4H-03A1	3	5.08	12.92
XW4H-04A1	4	7.62	15.46
XW4H-05A1	5	10.16	18.00
XW4H-06A1	6	12.70	20.54
XW4H-07A1	7	15.24	23.08
XW4H-08A1	8	17.78	25.62
XW4H-09A1	9	20.32	28.16
XW4H-10A1	10	22.86	30.70
XW4H-11A1	11	25.40	33.24
XW4H-12A1	12	27.94	35.78

### Models

Appearance	Connector, Wire-side Sockets	
	Models	Minimum ordering quantity (pieces)
	XW4H-02A1	100
	XW4H-03A1	
	XW4H-04A1	
	XW4H-05A1	75
	XW4H-06A1	
	XW4H-07A1	
	XW4H-08A1	50
	XW4H-09A1	
	XW4H-10A1	
	XW4H-11A1	25
	XW4H-12A1	

### Mating Diagram

(Unit: mm)

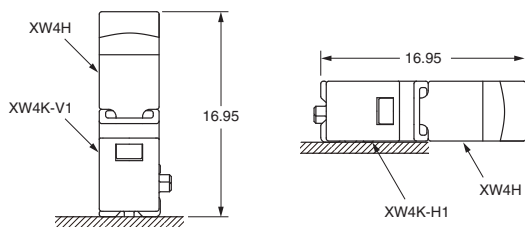

# XW4K Connectors, Board Side, Vertical and Horizontal

## Dimensions

(Unit: mm)

### Vertical

#### XW4K-□□A1-V1

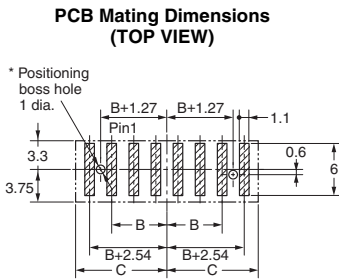
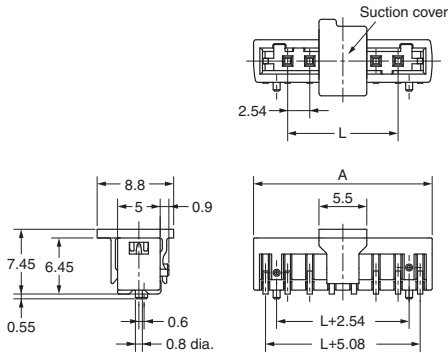

(Tolerance: ±0.05)  
 Note: The overall pattern pitch tolerance for the board is ±0.05. Do not accumulate error.  
 \* The 1-mm diameter holes are for the positioning bosses. Use metal masks to prevent solder from entering these holes.

### Dimensions

Models	Number of contacts	L	A	B	C
XW4K-02A1-V1	2	2.54	10.39	1.27	5.42
XW4K-03A1-V1	3	5.08	12.93	2.54	6.69
XW4K-04A1-V1	4	7.62	15.47	3.81	7.96
XW4K-05A1-V1	5	10.16	18.01	5.08	9.23
XW4K-06A1-V1	6	12.70	20.55	6.35	10.50
XW4K-07A1-V1	7	15.24	23.09	7.62	11.77
XW4K-08A1-V1	8	17.78	25.63	8.89	13.04
XW4K-09A1-V1	9	20.32	28.17	10.16	14.31
XW4K-10A1-V1	10	22.86	30.71	11.43	15.58
XW4K-11A1-V1	11	25.40	33.25	12.70	16.85
XW4K-12A1-V1	12	27.94	35.79	13.97	18.12

### Horizontal

#### XW4K-□□A1-H1

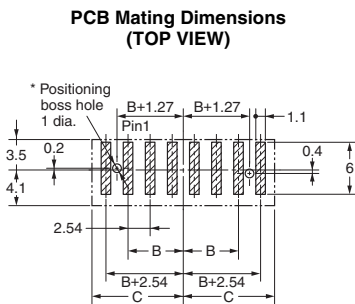
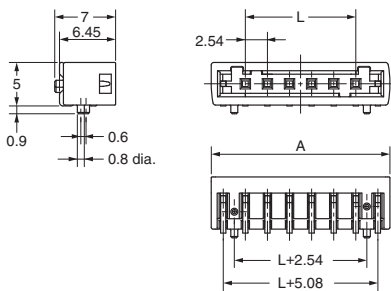

(Tolerance: ±0.05)  
 Note: The overall pattern pitch tolerance for the board is ±0.05. Do not accumulate error.  
 \* The 1-mm diameter holes are for the positioning bosses. Use metal masks to prevent solder from entering these holes.

### Dimensions

Models	Number of contacts	L	A	B	C
XW4K-02A1-H1	2	2.54	10.39	1.27	5.42
XW4K-03A1-H1	3	5.08	12.93	2.54	6.69
XW4K-04A1-H1	4	7.62	15.47	3.81	7.96
XW4K-05A1-H1	5	10.16	18.01	5.08	9.23
XW4K-06A1-H1	6	12.70	20.55	6.35	10.50
XW4K-07A1-H1	7	15.24	23.09	7.62	11.77
XW4K-08A1-H1	8	17.78	25.63	8.89	13.04
XW4K-09A1-H1	9	20.32	28.17	10.16	14.31
XW4K-10A1-H1	10	22.86	30.71	11.43	15.58
XW4K-11A1-H1	11	25.40	33.25	12.70	16.85
XW4K-12A1-H1	12	27.94	35.79	13.97	18.12

## Models

Appearance	Connector, Board-side Vertical Plugs		Connector, Board-side Horizontal Plugs	
	500 pcs per reel *	100 pcs per reel *	600 pcs per reel *	100 pcs per reel *
Number of contacts				
2	XW4K-02A1-V1	XW4K-02A1-V1-R100	XW4K-02A1-H1	XW4K-02A1-H1-R100
3	XW4K-03A1-V1	XW4K-03A1-V1-R100	XW4K-03A1-H1	XW4K-03A1-H1-R100
4	XW4K-04A1-V1	XW4K-04A1-V1-R100	XW4K-04A1-H1	XW4K-04A1-H1-R100
5	XW4K-05A1-V1	XW4K-05A1-V1-R100	XW4K-05A1-H1	XW4K-05A1-H1-R100
6	XW4K-06A1-V1	XW4K-06A1-V1-R100	XW4K-06A1-H1	XW4K-06A1-H1-R100
7	XW4K-07A1-V1	XW4K-07A1-V1-R100	XW4K-07A1-H1	XW4K-07A1-H1-R100
8	XW4K-08A1-V1	XW4K-08A1-V1-R100	XW4K-08A1-H1	XW4K-08A1-H1-R100
9	XW4K-09A1-V1	XW4K-09A1-V1-R100	XW4K-09A1-H1	XW4K-09A1-H1-R100
10	XW4K-10A1-V1	XW4K-10A1-V1-R100	XW4K-10A1-H1	XW4K-10A1-H1-R100
11	XW4K-11A1-V1	XW4K-11A1-V1-R100	XW4K-11A1-H1	XW4K-11A1-H1-R100
12	XW4K-12A1-V1	XW4K-12A1-V1-R100	XW4K-12A1-H1	XW4K-12A1-H1-R100

\* Please order an integer multiple of the quantity per reel.

# XW4H/XW4K/XW4L

## XW4L Direct Board Mounting, Vertical and Horizontal

### Dimensions

(Unit: mm)

#### Vertical

##### XW4L-□□A1-V1

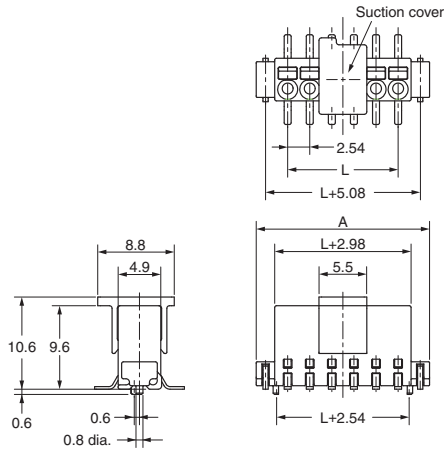

#### PCB Mating Dimensions (TOP VIEW)

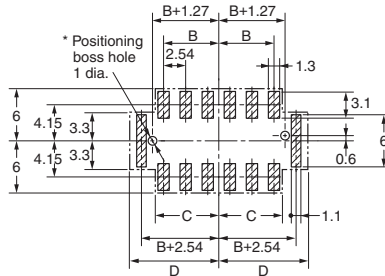

(Tolerance:  $\pm 0.05$ )

Note: The overall pattern pitch tolerance for the board is  $\pm 0.05$ . Do not accumulate error.

\* The 1-mm diameter holes are for the positioning bosses. Use metal masks to prevent solder from entering these holes.

#### Dimensions

Models	Number of contacts	L	A	B	C	D
XW4L-02A1-V1	2	2.54	9.77	1.27	2.22	5.16
XW4L-03A1-V1	3	5.08	12.31	2.54	3.49	6.43
XW4L-04A1-V1	4	7.62	14.85	3.81	4.76	7.70
XW4L-05A1-V1	5	10.16	17.39	5.08	6.03	8.97
XW4L-06A1-V1	6	12.70	19.93	6.35	7.30	10.24
XW4L-07A1-V1	7	15.24	22.47	7.62	8.57	11.51
XW4L-08A1-V1	8	17.78	25.01	8.89	9.84	12.78
XW4L-09A1-V1	9	20.32	27.55	10.16	11.11	14.05
XW4L-10A1-V1	10	22.86	30.09	11.43	12.38	15.32
XW4L-11A1-V1	11	25.40	32.63	12.70	13.65	16.59
XW4L-12A1-V1	12	27.94	35.17	13.97	14.92	17.86

#### Horizontal

##### XW4L-□□A1-H1

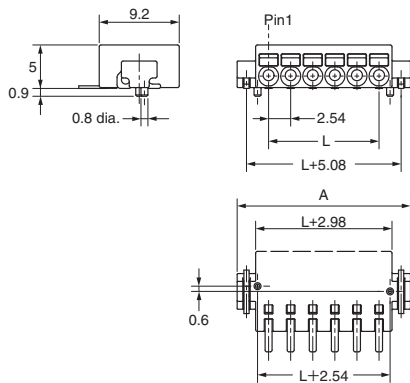

#### PCB Mating Dimensions (TOP VIEW)

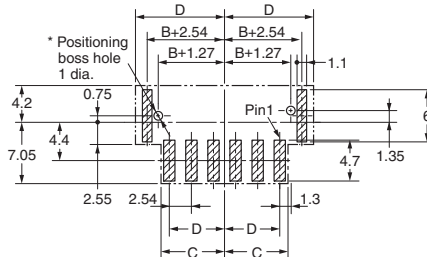

(Tolerance:  $\pm 0.05$ )

Note: The overall pattern pitch tolerance for the board is  $\pm 0.05$ . Do not accumulate error.

\* The 1-mm diameter holes are for the positioning bosses. Use metal masks to prevent solder from entering these holes.

#### Dimensions

Models	Number of contacts	L	A	B	C	D
XW4L-02A1-H1	2	2.54	9.77	1.27	2.22	5.16
XW4L-03A1-H1	3	5.08	12.31	2.54	3.49	6.43
XW4L-04A1-H1	4	7.62	14.85	3.81	4.76	7.70
XW4L-05A1-H1	5	10.16	17.39	5.08	6.03	8.97
XW4L-06A1-H1	6	12.70	19.93	6.35	7.30	10.24
XW4L-07A1-H1	7	15.24	22.47	7.62	8.57	11.51
XW4L-08A1-H1	8	17.78	25.01	8.89	9.84	12.78
XW4L-09A1-H1	9	20.32	27.55	10.16	11.11	14.05
XW4L-10A1-H1	10	22.86	30.09	11.43	12.38	15.32
XW4L-11A1-H1	11	25.40	32.63	12.70	13.65	16.59
XW4L-12A1-H1	12	27.94	35.17	13.97	14.92	17.86

## Models

Appearance	Direct-board-mounting, Vertical Sockets		Direct-board-mounting, Horizontal Sockets	
	250 pcs per reel *	100 pcs per reel *	500 pcs per reel *	100 pcs per reel *
2	XW4L-02A1-V1	XW4L-02A1-V1-R100	XW4L-02A1-H1	XW4L-02A1-H1-R100
3	XW4L-03A1-V1	XW4L-03A1-V1-R100	XW4L-03A1-H1	XW4L-03A1-H1-R100
4	XW4L-04A1-V1	XW4L-04A1-V1-R100	XW4L-04A1-H1	XW4L-04A1-H1-R100
5	XW4L-05A1-V1	XW4L-05A1-V1-R100	XW4L-05A1-H1	XW4L-05A1-H1-R100
6	XW4L-06A1-V1	XW4L-06A1-V1-R100	XW4L-06A1-H1	XW4L-06A1-H1-R100
7	XW4L-07A1-V1	XW4L-07A1-V1-R100	XW4L-07A1-H1	XW4L-07A1-H1-R100
8	XW4L-08A1-V1	XW4L-08A1-V1-R100	XW4L-08A1-H1	XW4L-08A1-H1-R100
9	XW4L-09A1-V1	XW4L-09A1-V1-R100	XW4L-09A1-H1	XW4L-09A1-H1-R100
10	XW4L-10A1-V1	XW4L-10A1-V1-R100	XW4L-10A1-H1	XW4L-10A1-H1-R100
11	XW4L-11A1-V1	XW4L-11A1-V1-R100	XW4L-11A1-H1	XW4L-11A1-H1-R100
12	XW4L-12A1-V1	XW4L-12A1-V1-R100	XW4L-12A1-H1	XW4L-12A1-H1-R100

\* Please order an integer multiple of the quantity per reel.

## Accessories

### Special Screwdriver XW4Z-00A



Models	Minimum ordering quantity (pieces)
XW4Z-00A	1

## Safety Precautions

### Precautions for Correct Use

#### ● Soldering Conditions

- Recommended Reflow Conditions  
Maximum temperature: 255°C  
Time: Within 20 s

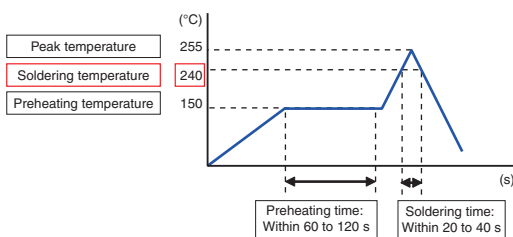

These conditions depend on the type of solder, the manufacturer, the amount of solder, the size of the circuit board, and the other mounting materials. You must check and select the actual conditions yourself.

#### ● Metal Mask Thickness for Cream Solder Printing

We recommend a metal mask thickness of 0.12 to 0.15 mm for cream solder printing.

These conditions, however, depend on the type of solder, the manufacturer, the amount of solder, the size of the circuit board, and the other mounting materials. You must check and select the actual conditions.

#### ● Pin Deformation

The pins will deform if you subject them to an excessive load. Deformed pins will reduce solderability when the Connectors are mounted. Do not drop the Connectors or handle them roughly. Do not connect or disconnect Connectors that are not mounted to a circuit board. Doing so may deform the pins.



## XW4H, XW4L

### ● Wiring Terminal Blocks

#### Directly Connecting Wires

- (1) Use wires with conductors that are within the connectible wire range.
- (2) Prepare the ends of the wires as shown below.  
Refer to Ratings and Specifications for the wire stripping length.

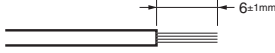

- (3) Do not presolder the ends of the wires. Doing so will prevent correct connections.

### ● Connection Methods

#### Using Ferrules or Solid Wire

##### Connection Method



Just press the ferrule all the way in.

##### Removal Method



Insert the screwdriver into the release hole and pull out the ferrule.

#### Using Stranded Wires

##### Using Stranded Wires

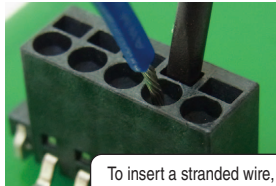

To insert a stranded wire, insert a screwdriver into the release hole and then insert the wire.  
To remove a stranded wire, insert a screwdriver into the release hole and then pull out the wire.

**Note:** Do not apply excessive force to the Terminal Block when you insert the tool. The Terminal Block may be damaged.

### ● Terminal Block Connection Method

#### Using Crimp Terminals

- (1) Use ferrules or tab terminals.  
However, the Terminal Blocks are small, so sufficiently confirm the following before you use them.
- (2) Insulation between Crimp Terminals  
If you use naked crimp terminals, there will be no finger protection. Also, there will be limited clearance and creepage distances between adjacent terminals, so use crimp terminals with care.

#### ● Special Screwdriver for Terminal Blocks

Use the XW4Z-00A Special Screwdriver to connect the Terminal Blocks.

You can also use any screwdriver with the following dimensions. If you use any screwdriver other than the Special Screwdriver or one with the following dimensions, the Terminal Block may be damaged.

(Unit: mm)

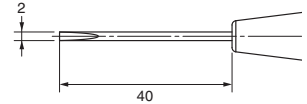
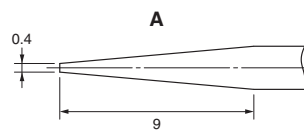

• Application examples provided in this document are for reference only. In actual applications, confirm equipment functions and safety before using the product.  
• Consult your OMRON representative before using the product under conditions which are not described in the manual or applying the product to nuclear control systems, railroad systems, aviation systems, vehicles, combustion systems, medical equipment, amusement machines, safety equipment, and other systems or equipment that may have a serious influence on lives and property if used improperly. Make sure that the ratings and performance characteristics of the product provide a margin of safety for the system or equipment, and be sure to provide the system or equipment with double safety mechanisms.

**Note: Do not use this document to operate the Unit.**

**OMRON Corporation**

Electronic and Mechanical Components Company

Contact: [www.omron.com/ecb](http://www.omron.com/ecb)

Cat. No. G090-E1-03  
0816(0515)