



Chipsmall Limited consists of a professional team with an average of over 10 year of expertise in the distribution of electronic components. Based in Hongkong, we have already established firm and mutual-benefit business relationships with customers from,Europe,America and south Asia,supplying obsolete and hard-to-find components to meet their specific needs.

With the principle of “Quality Parts,Customers Priority,Honest Operation,and Considerate Service”,our business mainly focus on the distribution of electronic components. Line cards we deal with include Microchip,ALPS,ROHM,Xilinx,Pulse,ON,Everlight and Freescale. Main products comprise IC,Modules,Potentiometer,IC Socket,Relay,Connector.Our parts cover such applications as commercial,industrial, and automotives areas.

We are looking forward to setting up business relationship with you and hope to provide you with the best service and solution. Let us make a better world for our industry!



Contact us

Tel: +86-755-8981 8866 Fax: +86-755-8427 6832

Email & Skype: info@chipsmall.com Web: www.chipsmall.com

Address: A1208, Overseas Decoration Building, #122 Zhenhua RD., Futian, Shenzhen, China



Features

- 0.4 inch digit height
- Robust package
- Low power consumption
- Standard configuration: Gray face w/ white segments
- Standard Package: 250pcs/ Reel
- MSL (Moisture Sensitivity Level): 2a
- RoHS Compliant



ATTENTION
OBSERVE PRECAUTIONS
FOR HANDLING
ELECTROSTATIC
DISCHARGE
SENSITIVE
DEVICES

Package Schematics

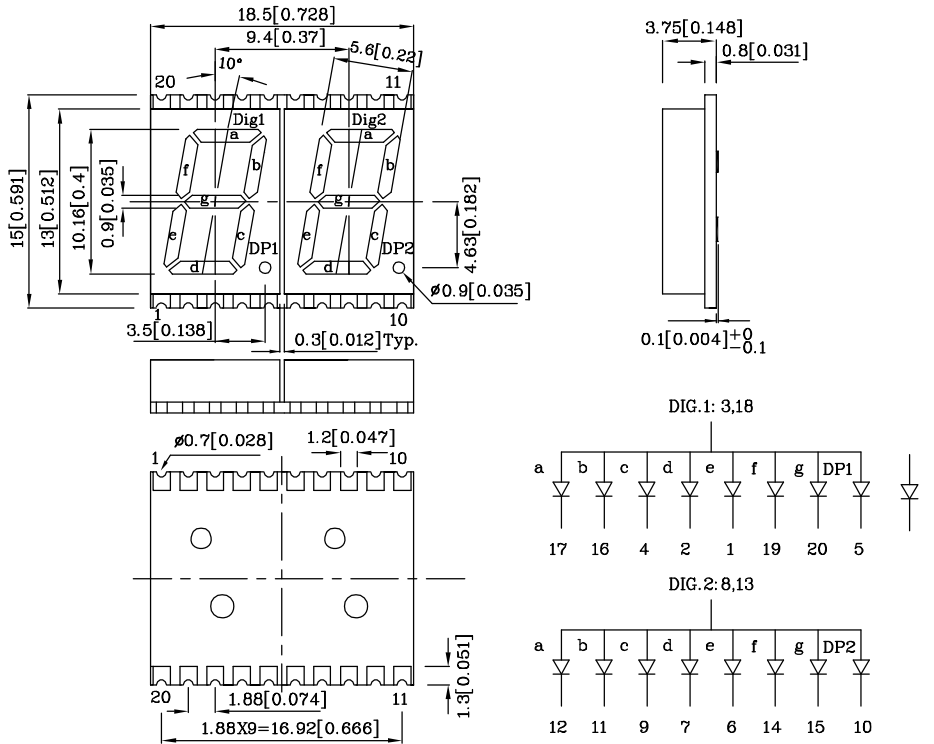

Notes:

1. All dimensions are in millimeters (inches), Tolerance is $\pm 0.25(0.01)$ unless otherwise noted.
2. Specifications are subject to change without notice.
3. The gap between the reflector and PCB shall not exceed 0.25mm.

Absolute Maximum Ratings (T _A =25°C)		Yellow (AlGaInP)	Unit
Reverse Voltage	V _R	5	V
Forward Current	I _F	30	mA
Forward Current (Peak) 1/10 Duty Cycle 0.1ms Pulse Width	i _{FS}	175	mA
Power Dissipation	P _D	75	mW
Operating Temperature	T _A	-40 ~ +85	°C
Storage Temperature	T _{stg}	-40 ~ +85	

A Relative Humidity between 40% and 60% is recommended in ESD-protected work areas to reduce static build up during assembly process (Reference JEDEC/JESD625-A and JEDEC/J-STD-033)

Operating Characteristics (T _A =25°C)		Yellow (AlGaInP)	Unit
Forward Voltage (Typ.) (I _F =10mA)	V _F	1.95	V
Forward Voltage (Max.) (I _F =10mA)	V _F	2.5	V
Reverse Current (Max.) (V _R =5V)	I _R	10	uA
Wavelength of Peak Emission CIE127-2007* (Typ.) (I _F =10mA)	λ _P	590*	nm
Wavelength of Dominant Emission CIE127-2007* (Typ.) (I _F =10mA)	λ _D	590*	nm
Spectral Line Full Width At Half-Maximum (Typ.) (I _F =10mA)	Δλ	20	nm
Capacitance (Typ.) (V _F =0V, f=1MHz)	C	20	pF

Part Number	Emitting Color	Emitting Material	Luminous Intensity CIE127-2007* (I _F =10mA) ucd		Wavelength CIE127-2007* nm λ _P	Description
			min.	typ.		
XZFMKY10A2	Yellow	AlGaInP	31000 9000*	72990 22990*	590*	Common Anode, Rt.Hand Decimal.

*Luminous intensity value and wavelength are in accordance with CIE127-2007 standards.

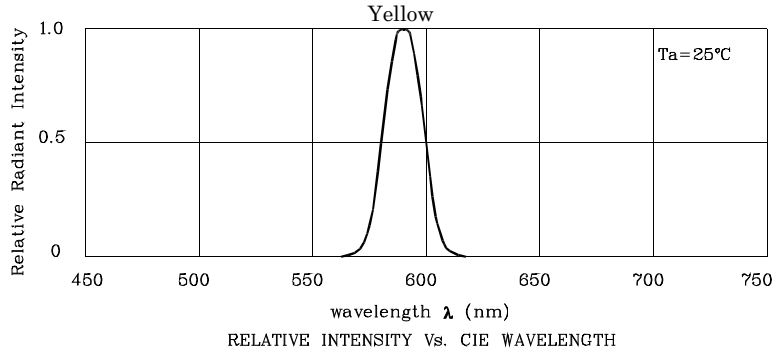

❖ Yellow

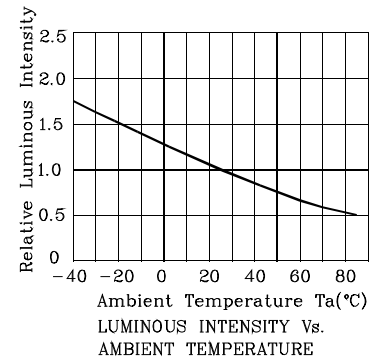
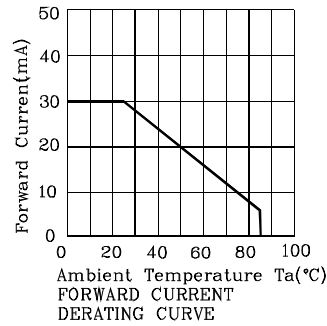
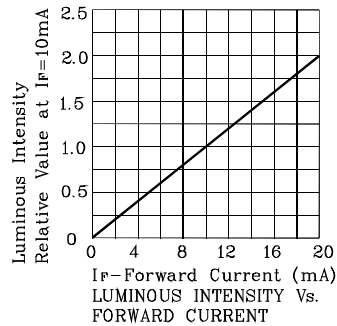
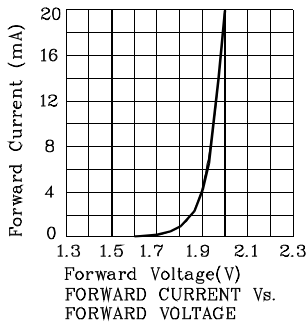

LED is recommended for reflow soldering and soldering profile is shown below.

Reflow Soldering Profile for SMD Products (Pb-Free Components)



Notes:

1. Maximum soldering temperature should not exceed 260°C
2. Recommended reflow temperature: 145°C-260°C
3. Do not put stress to the epoxy resin during high temperatures conditions



❖ Recommended Soldering Pattern (Units : mm; Tolerance: ± 0.15)

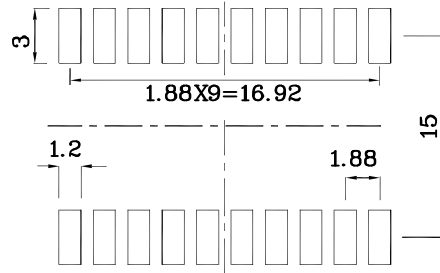

❖ Tape Specification (Units : mm)

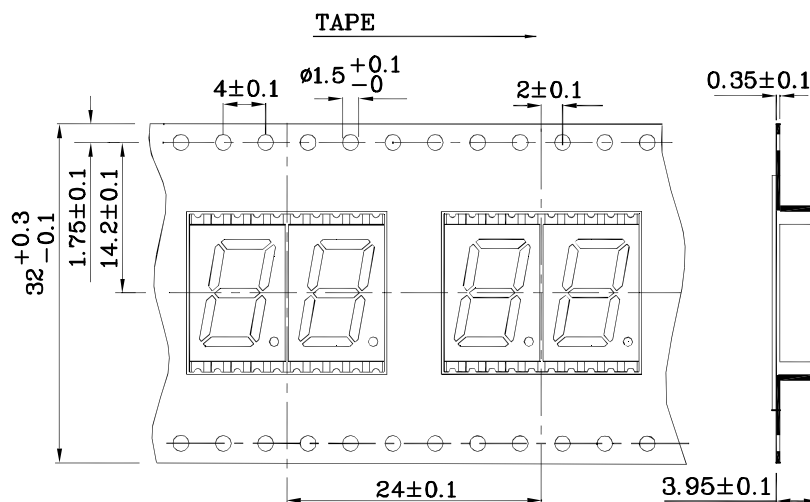

❖ Reel Dimension

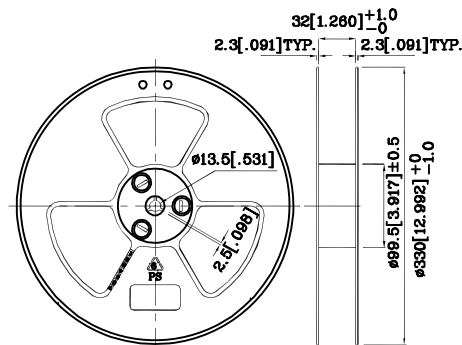

Remarks:

If special sorting is required (e.g. binning based on forward voltage, Luminous intensity / luminous flux, or wavelength), the typical accuracy of the sorting process is as follows:

1. Wavelength: ± 1 nm
2. Luminous intensity / luminous flux: $\pm 15\%$
3. Forward Voltage: ± 0.1 V

Note: Accuracy may depend on the sorting parameters.

PACKING & LABEL SPECIFICATIONS

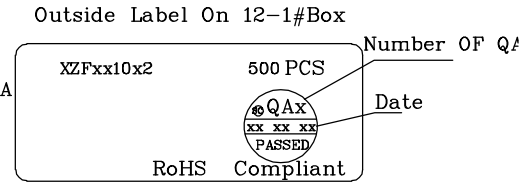
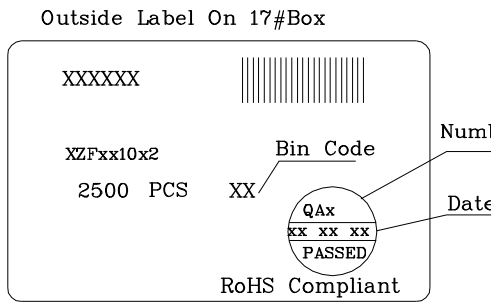
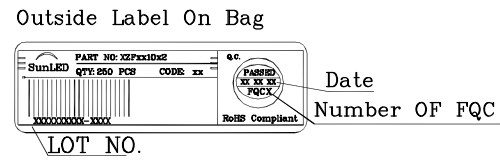
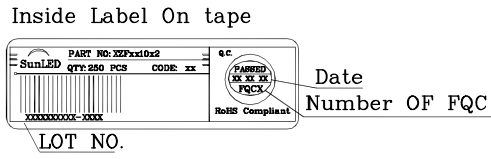
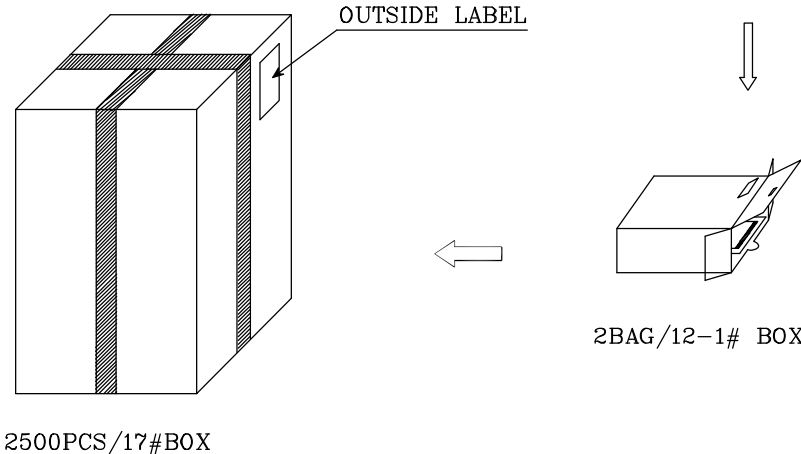
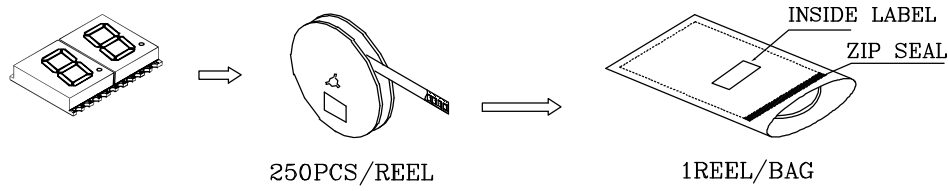

TERMS OF USE

1. Data presented in this document reflect statistical figures and should be treated as technical reference only.
2. Contents within this document are subject to improvement and enhancement changes without notice.
3. The product(s) in this document are designed to be operated within the electrical and environmental specifications indicated on the datasheet. User accepts full risk and responsibility when operating the product(s) beyond their intended specifications.
4. The product(s) described in this document are intended for electronic applications in which a person's life is not reliant upon the LED. Please consult with a SunLED representative for special applications where the LED may have a direct impact on a person's life.
5. The contents within this document may not be altered without prior consent by SunLED.
6. Additional technical notes are available at <http://www.SunLEDusa.com/TechnicalNotes.asp>