



Chipsmall Limited consists of a professional team with an average of over 10 year of expertise in the distribution of electronic components. Based in Hongkong, we have already established firm and mutual-benefit business relationships with customers from,Europe,America and south Asia,supplying obsolete and hard-to-find components to meet their specific needs.

With the principle of "Quality Parts,Customers Priority,Honest Operation,and Considerate Service",our business mainly focus on the distribution of electronic components. Line cards we deal with include Microchip,ALPS,ROHM,Xilinx,Pulse,ON,Everlight and Freescale. Main products comprise IC,Modules,Potentiometer,IC Socket,Relay,Connector.Our parts cover such applications as commercial,industrial, and automotives areas.

We are looking forward to setting up business relationship with you and hope to provide you with the best service and solution. Let us make a better world for our industry!



## Contact us

Tel: +86-755-8981 8866 Fax: +86-755-8427 6832

Email & Skype: info@chipsmall.com Web: www.chipsmall.com

Address: A1208, Overseas Decoration Building, #122 Zhenhua RD., Futian, Shenzhen, China



# Z0107MA

## Sensitive Gate Triacs Series

### Silicon Bidirectional Thyristors

Designed for use in solid state relays, MPU interface, TTL logic and any other light industrial or consumer application. Supplied in an inexpensive TO-92 package which is readily adaptable for use in automatic insertion equipment.

#### Features

- One-Piece, Injection-Molded Package
- Blocking Voltage to 600 V
- Sensitive Gate Triggering in Four Trigger Modes (Quadrants) for all possible Combinations of Trigger Sources, and especially for Circuits that Source Gate Drives
- All Diffused and Glassivated Junctions for Maximum Uniformity of Parameters and Reliability
- Improved Noise Immunity (dv/dt Minimum of 10 V/ $\mu$ sec at 110°C)
- Commutating di/dt of 1.6 A/msec at 110°C
- High Surge Current of 8 A
- These are Pb-Free Devices

#### MAXIMUM RATINGS ( $T_J = 25^\circ\text{C}$ unless otherwise noted)

Rating	Symbol	Value	Unit
Peak Repetitive Off-State Voltage ( $T_J = -40$ to $+125^\circ\text{C}$ ) <sup>(1)</sup> Sine Wave 50 to 60 Hz, Gate Open	$V_{DRM}$ , $V_{RRM}$	600	V
On-State RMS Current Full Cycle Sine Wave 50 to 60 Hz ( $T_C = 50^\circ\text{C}$ )	$I_{T(RMS)}$	1.0	A
Peak Non-Repetitive Surge Current One Full Cycle, Sine Wave 60 Hz ( $T_C = 110^\circ\text{C}$ )	$I_{TSM}$	8.0	A
Circuit Fusing Considerations ( $t = 8.3$ ms)	$I^2t$	0.35	A <sup>2</sup> s
Average Gate Power ( $T_C = 80^\circ\text{C}$ , $t \leq 8.3$ ms)	$P_{G(AV)}$	1.0	W
Peak Gate Current ( $t \leq 20$ $\mu$ s, $T_J = +125^\circ\text{C}$ )	$I_{GM}$	1.0	A
Operating Junction Temperature Range	$T_J$	-40 to +125	$^\circ\text{C}$
Storage Temperature Range	$T_{stg}$	-40 to +150	$^\circ\text{C}$

Stresses exceeding Maximum Ratings may damage the device. Maximum Ratings are stress ratings only. Functional operation above the Recommended Operating Conditions is not implied. Extended exposure to stresses above the Recommended Operating Conditions may affect device reliability.

1.  $V_{DRM}$  and  $V_{RRM}$  for all types can be applied on a continuous basis. Blocking voltages shall not be tested with a constant current source such that the voltage ratings of the devices are exceeded.



**ON Semiconductor**

<http://onsemi.com>

**TRIACS**  
**1.0 AMPERE RMS**  
**600 VOLTS**

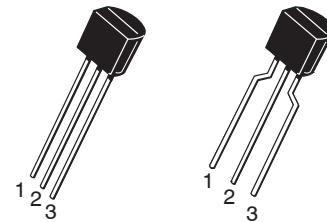
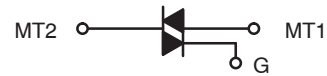

STRAIGHT LEAD  
BULK PACK

BENT LEAD  
TAPE & REEL  
AMMO PACK

**TO-92 (TO-226AA)**  
**CASE 029**  
**STYLE 12**

#### MARKING DIAGRAM

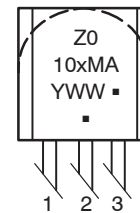

x = 3,7,9  
Y = Year  
WW = Work Week  
▪ = Pb-Free Package  
(\*Note: Microdot may be in either location)

#### PIN ASSIGNMENT

1	Main Terminal 1
2	Gate
3	Main Terminal 2

#### ORDERING INFORMATION

See detailed ordering and shipping information in the package dimensions section on page 6 of this data sheet.

# Z0107MA

## THERMAL CHARACTERISTICS

Characteristic	Symbol	Max	Unit
Thermal Resistance, Junction-to-Case	$R_{\theta JC}$	50	$^{\circ}\text{C}/\text{W}$
Thermal Resistance, Junction-to-Ambient	$R_{\theta JA}$	160	$^{\circ}\text{C}/\text{W}$
Maximum Lead Temperature for Soldering Purposes for 10 Seconds	$T_L$	260	$^{\circ}\text{C}$

## ELECTRICAL CHARACTERISTICS ( $T_C = 25^{\circ}\text{C}$ unless otherwise noted; Electricals apply in both directions)

Characteristic	Symbol	Min	Typ	Max	Unit
----------------	--------	-----	-----	-----	------

### OFF CHARACTERISTICS

Peak Repetitive Blocking Current ( $V_D = \text{Rated } V_{\text{DRM}}, V_{\text{RRM}}; \text{ Gate Open}$ )	$T_J = 25^{\circ}\text{C}$ $T_J = +125^{\circ}\text{C}$	$I_{\text{DRM}}, I_{\text{RRM}}$	- -	- -	5.0 500	$\mu\text{A}$
---	--	----------------------------------	--------	--------	------------	---------------

### ON CHARACTERISTICS

Peak On-State Voltage ( $I_{\text{TM}} = \pm 1.4 \text{ A Peak}; \text{ Pulse Width} \leq 2.0 \text{ ms}, \text{ Duty Cycle} \leq 2.0\%$ )	$V_{\text{TM}}$	-	-	1.56	V
Gate Trigger Current (Continuous dc) ( $V_D = 12 \text{ Vdc}, R_L = 30 \Omega$ ) MT2(+), G(+) MT2(+), G(-) MT2(-), G(-) MT2(-), G(+)	$I_{\text{GT}}$	0.15 0.15 0.15 0.25	- - - -	5.0 5.0 5.0 7.0	mA
Latching Current ( $V_D = 12 \text{ V}, I_G = 1.2 \times I_{\text{GT}}$ ) MT2(+), G(+) MT2(+), G(-) MT2(-), G(-) MT2(-), G(+)	$I_L$	- - - -	- - - -	10 20 10 10	mA
Gate Trigger Voltage (Continuous dc) ( $V_D = 12 \text{ Vdc}, R_L = 30 \Omega$ ) MT2(+), G(+) MT2(+), G(-) MT2(-), G(-) MT2(-), G(+)	$V_{\text{GT}}$	- - - -	- - - -	1.3 1.3 1.3 1.3	V
Gate Non-Trigger Voltage ( $V_D = 12 \text{ V}, R_L = 30 \Omega, T_J = 125^{\circ}\text{C}$ ) All Four Quadrants	$V_{\text{GD}}$	0.2	-	1.3	V
Holding Current ( $V_D = 12 \text{ Vdc}, \text{ Initiating Current} = 50 \text{ mA}, \text{ Gate Open}$ )	$I_H$	-	-	10	mA

### DYNAMIC CHARACTERISTICS

Rate of Change of Commutating Current ( $V_D = 400 \text{ V}, I_{\text{TM}} = 0.84 \text{ A}, \text{ Commutating } dv/dt = 1.5 \text{ V}/\mu\text{s}, \text{ Gate Open}, T_J = 110^{\circ}\text{C}, f = 250 \text{ Hz}, \text{ with Snubber}$ )	$di/dt(c)$	1.6	-	-	A/ms
Critical Rate of Rise of Off-State Voltage ( $V_D = 67\% \text{ Rated } V_{\text{DRM}}, \text{ Exponential Waveform}, \text{ Gate Open}, T_J = 110^{\circ}\text{C}$ )	$dv/dt$	20	60	-	V/ $\mu\text{s}$
Repetitive Critical Rate of Rise of On-State Current, $T_J = 125^{\circ}\text{C}$ Pulse Width = 20 $\mu\text{s}$ , $IPK_{\text{max}} = 15 \text{ A}, diG/dt = 1 \text{ A}/\mu\text{s}, f = 60 \text{ Hz}$	$di/dt$	-	-	20	A/ $\mu\text{s}$

# Z0107MA

## Voltage Current Characteristic of Triacs (Bidirectional Device)

Symbol	Parameter
$V_{DRM}$	Peak Repetitive Forward Off State Voltage
$I_{DRM}$	Peak Forward Blocking Current
$V_{RRM}$	Peak Repetitive Reverse Off State Voltage
$I_{RRM}$	Peak Reverse Blocking Current
$V_{TM}$	Maximum On State Voltage
$I_H$	Holding Current

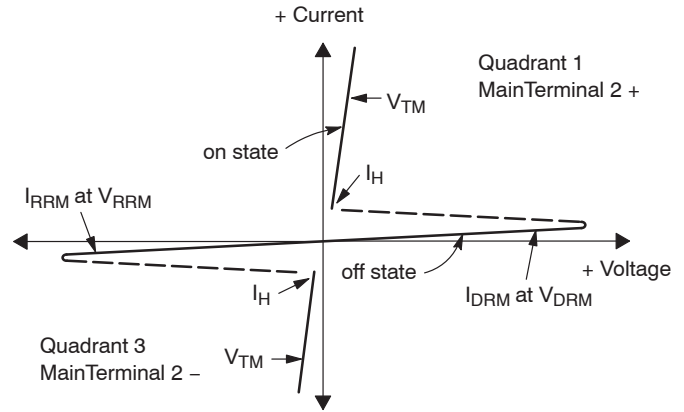

### Quadrant Definitions for a Triac

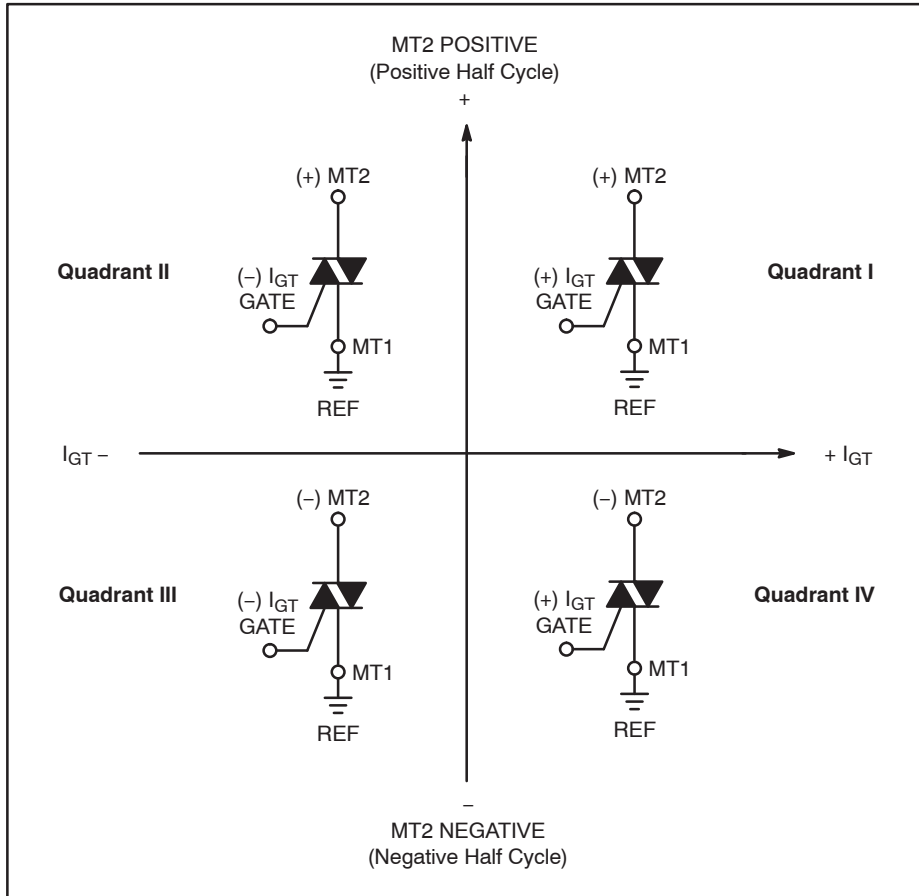

All polarities are referenced to MT1.

With in-phase signals (using standard AC lines) quadrants I and III are used.

# Z0107MA

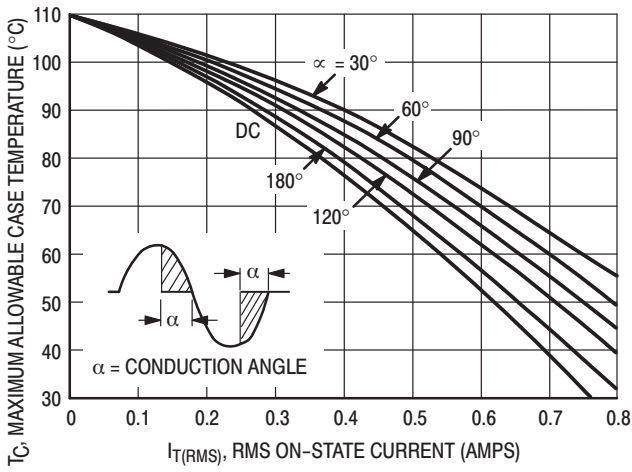

Figure 1. RMS Current Derating

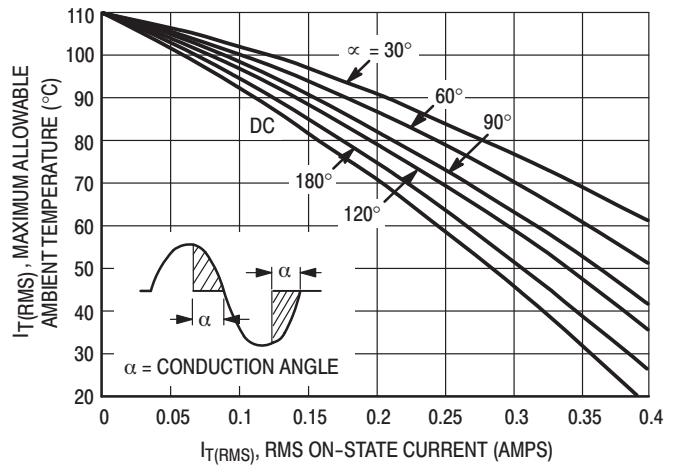

Figure 2. RMS Current Derating

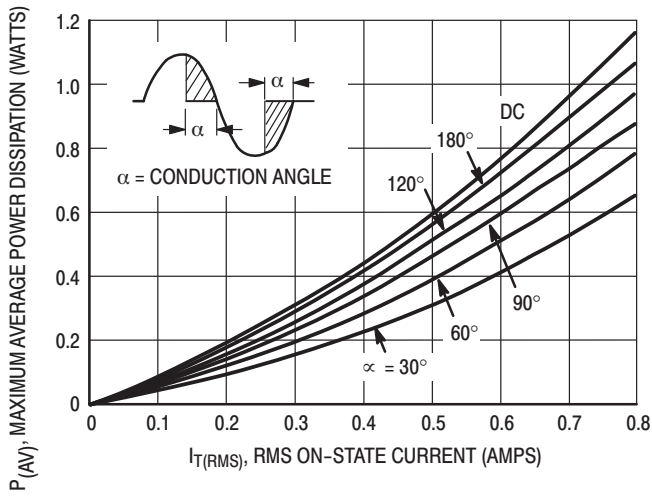

Figure 3. Power Dissipation

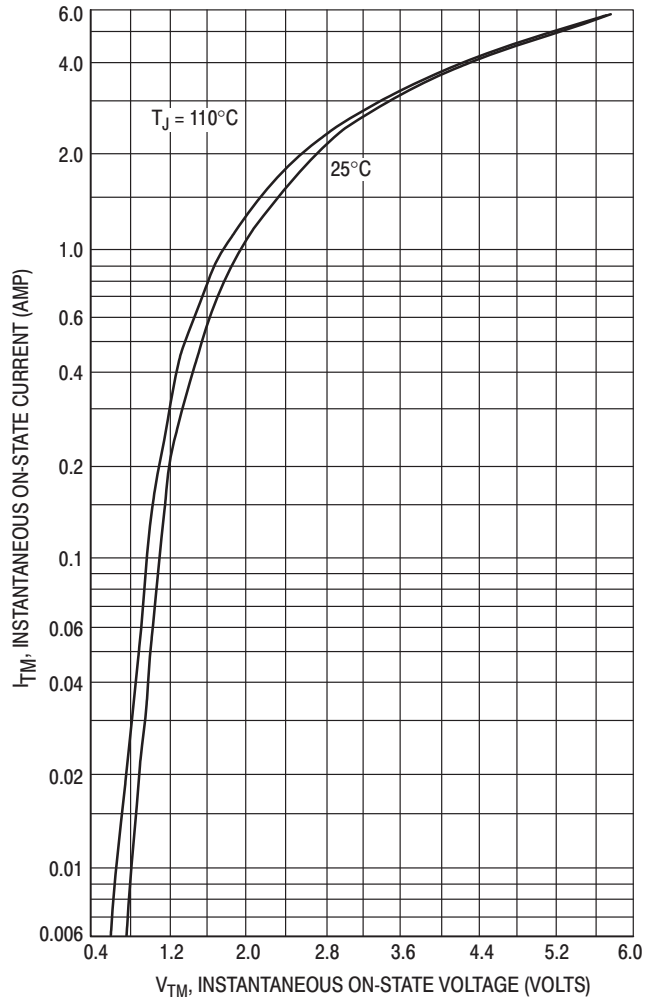

Figure 4. On-State Characteristics

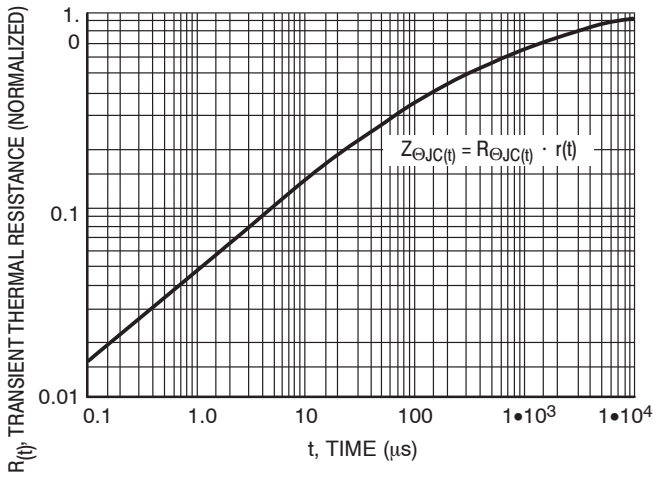

Figure 5. Transient Thermal Response

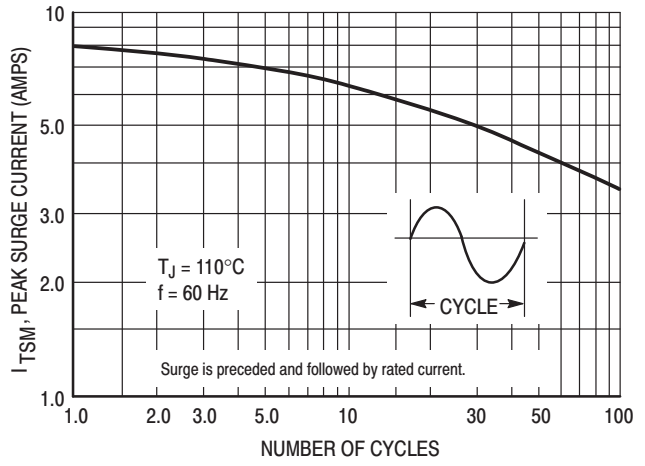

Figure 6. Maximum Allowable Surge Current

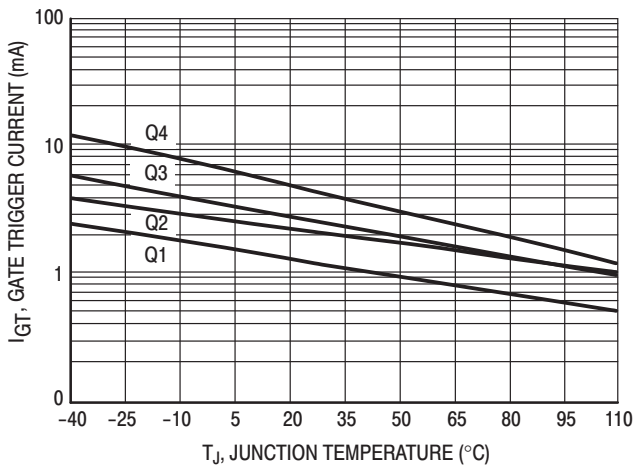

Figure 7. Typical Gate Trigger Current versus Junction Temperature

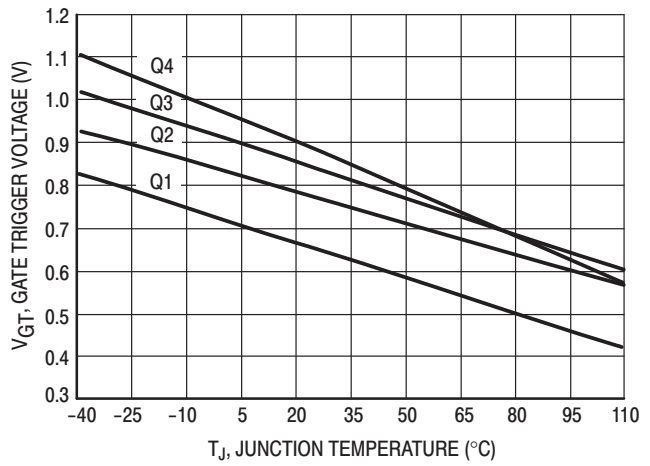

Figure 8. Typical Gate Trigger Voltage versus Junction Temperature

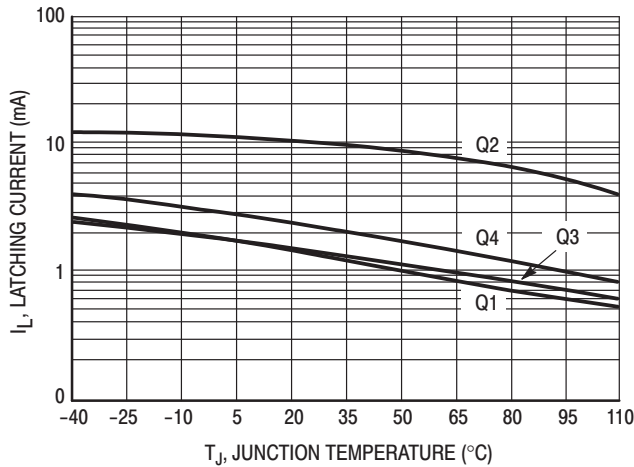

Figure 9. Typical Latching Current versus Junction Temperature

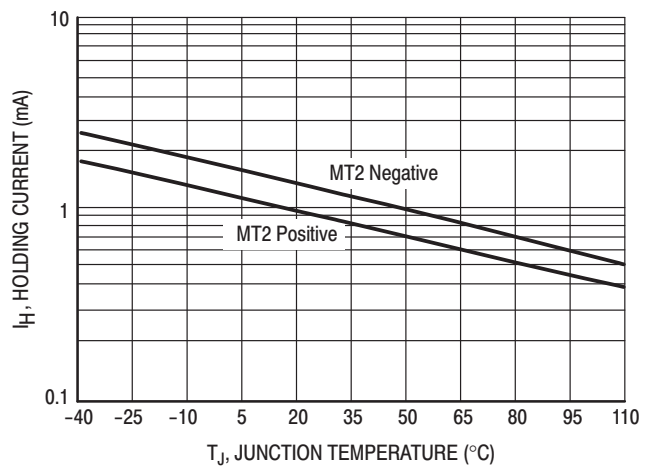
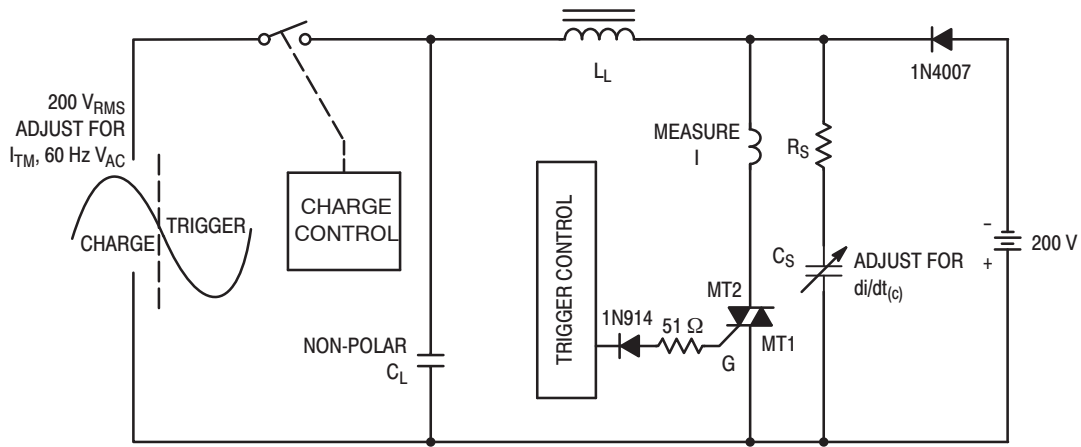

Figure 10. Typical Holding Current versus Junction Temperature

# Z0107MA



Note: Component values are for verification of rated  $(di/dt)_c$ . See AN1048 for additional information.

**Figure 11. Simplified Test Circuit to Measure the Critical Rate of Rise of Commutating Current  $(di/dt)_c$**

## ORDERING & SHIPPING INFORMATION: Packaging Options, Device Suffix

U.S.	Europe Equivalent	Shipping <sup>†</sup>	Description of TO-92 Tape Orientation
	Z0107MARL1G	Radial Tape and Reel (2K/Reel)	Flat side of TO-92 and adhesive tape visible
Z0107MAG		Bulk in Box (5K/Box)	N/A, Bulk
Z0107MARLRPG		Radial Tape and Fan Fold Box (2K/Box)	Round side of TO-92 and adhesive tape visible
Z0107MARLRFG		Radial Tape and Fan Fold Box (2K/Box)	Round side of TO-92 and adhesive tape on reverse side

<sup>†</sup>For information on tape and reel specifications, including part orientation and tape sizes, please refer to our Tape and Reel Packaging Specification Brochure, BRD8011/D.

# Z0107MA

## PACKAGE DIMENSIONS

TO-92 (TO-226AA)  
CASE 029-11  
ISSUE AM

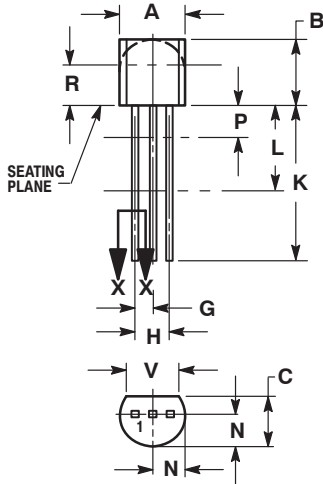

STRAIGHT LEAD  
BULK PACK

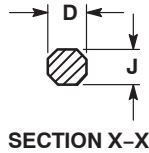

NOTES:

1. DIMENSIONING AND TOLERANCING PER ANSI Y14.5M, 1982.
2. CONTROLLING DIMENSION: INCH.
3. CONTOUR OF PACKAGE BEYOND DIMENSION R IS UNCONTROLLED.
4. LEAD DIMENSION IS UNCONTROLLED IN P AND BEYOND DIMENSION K MINIMUM.

DIM	INCHES		MILLIMETERS	
	MIN	MAX	MIN	MAX
A	0.175	0.205	4.45	5.20
B	0.170	0.210	4.32	5.33
C	0.125	0.165	3.18	4.19
D	0.016	0.021	0.407	0.533
G	0.045	0.055	1.15	1.39
H	0.095	0.105	2.42	2.66
J	0.015	0.020	0.39	0.50
K	0.500	---	12.70	---
L	0.250	---	6.35	---
N	0.080	0.105	2.04	2.66
P	---	0.100	---	2.54
R	0.115	---	2.93	---
V	0.135	---	3.43	---

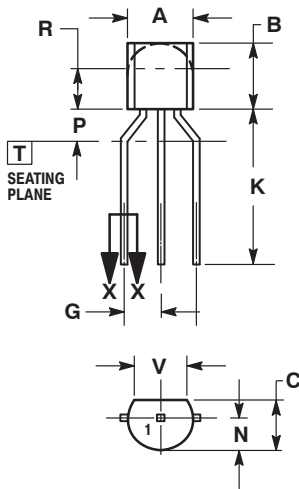

BENT LEAD  
TAPE & REEL  
AMMO PACK

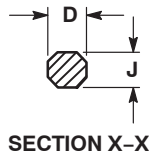

NOTES:

1. DIMENSIONING AND TOLERANCING PER ASME Y14.5M, 1994.
2. CONTROLLING DIMENSION: MILLIMETERS.
3. CONTOUR OF PACKAGE BEYOND DIMENSION R IS UNCONTROLLED.
4. LEAD DIMENSION IS UNCONTROLLED IN P AND BEYOND DIMENSION K MINIMUM.

DIM	MILLIMETERS	
	MIN	MAX
A	4.45	5.20
B	4.32	5.33
C	3.18	4.19
D	0.40	0.54
G	2.40	2.80
J	0.39	0.50
K	12.70	---
N	2.04	2.66
P	1.50	4.00
R	2.93	---
V	3.43	---

STYLE 12:

1. MAIN TERMINAL 1
2. GATE
3. MAIN TERMINAL 2

ON Semiconductor and are registered trademarks of Semiconductor Components Industries, LLC (SCILLC). SCILLC reserves the right to make changes without further notice to any products herein. SCILLC makes no warranty, representation or guarantee regarding the suitability of its products for any particular purpose, nor does SCILLC assume any liability arising out of the application or use of any product or circuit, and specifically disclaims any and all liability, including without limitation special, consequential or incidental damages. "Typical" parameters which may be provided in SCILLC data sheets and/or specifications can and do vary in different applications and actual performance may vary over time. All operating parameters, including "Typicals" must be validated for each customer application by customer's technical experts. SCILLC does not convey any license under its patent rights nor the rights of others. SCILLC products are not designed, intended, or authorized for use as components in systems intended for surgical implant into the body, or other applications intended to support or sustain life, or for any other application in which the failure of the SCILLC product could create a situation where personal injury or death may occur. Should Buyer purchase or use SCILLC products for any such unintended or unauthorized application, Buyer shall indemnify and hold SCILLC and its officers, employees, subsidiaries, affiliates, and distributors harmless against all claims, costs, damages, and expenses, and reasonable attorney fees arising out of, directly or indirectly, any claim of personal injury or death associated with such unintended or unauthorized use, even if such claim alleges that SCILLC was negligent regarding the design or manufacture of the part. SCILLC is an Equal Opportunity/Affirmative Action Employer. This literature is subject to all applicable copyright laws and is not for resale in any manner.

### PUBLICATION ORDERING INFORMATION

LITERATURE FULFILLMENT:

Literature Distribution Center for ON Semiconductor  
P.O. Box 5163, Denver, Colorado 80217 USA  
Phone: 303-675-2175 or 800-344-3860 Toll Free USA/Canada  
Fax: 303-675-2176 or 800-344-3867 Toll Free USA/Canada  
Email: orderlit@onsemi.com

N. American Technical Support: 800-282-9855 Toll Free  
USA/Canada  
Europe, Middle East and Africa Technical Support:  
Phone: 421 33 790 2910  
Japan Customer Focus Center  
Phone: 81-3-5817-1050

ON Semiconductor Website: [www.onsemi.com](http://www.onsemi.com)

Order Literature: <http://www.onsemi.com/orderlit>

For additional information, please contact your local Sales Representative