



Chipsmall Limited consists of a professional team with an average of over 10 year of expertise in the distribution of electronic components. Based in Hongkong, we have already established firm and mutual-benefit business relationships with customers from,Europe,America and south Asia,supplying obsolete and hard-to-find components to meet their specific needs.

With the principle of "Quality Parts,Customers Priority,Honest Operation,and Considerate Service",our business mainly focus on the distribution of electronic components. Line cards we deal with include Microchip,ALPS,ROHM,Xilinx,Pulse,ON,Everlight and Freescale. Main products comprise IC,Modules,Potentiometer,IC Socket,Relay,Connector.Our parts cover such applications as commercial,industrial, and automotives areas.

We are looking forward to setting up business relationship with you and hope to provide you with the best service and solution. Let us make a better world for our industry!



## Contact us

Tel: +86-755-8981 8866 Fax: +86-755-8427 6832

Email & Skype: info@chipsmall.com Web: www.chipsmall.com

Address: A1208, Overseas Decoration Building, #122 Zhenhua RD., Futian, Shenzhen, China



# SM-8 BIPOLAR TRANSISTOR H-BRIDGE

**ZHB6790**

PRELIMINARY DATA SHEET ISSUE B JULY 1997

## FEATURES

- \* Compact package
- \* Low on state losses
- \* Low drive requirements
- \* Operates up to 40V supply
- \* 2 Amp continuous rating

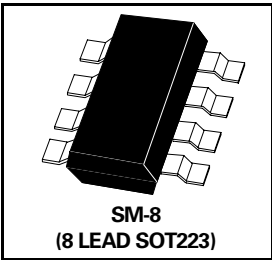

PARTMARKING DETAIL – ZHB6790

## ABSOLUTE MAXIMUM RATINGS.

PARAMETER	SYMBOL	NPNs	PNPs	UNIT
Collector-Base Voltage	$V_{CBO}$	50	-50	V
Collector-Emitter Voltage	$V_{CEO}$	40	-40	V
Emitter-Base Voltage	$V_{EBO}$	5	-5	V
Peak Pulse Current	$I_{CM}$	6	-6	A
Continuous Collector Current	$I_C$	2	-2	A
Operating and Storage Temperature Range	$T_j; T_{stg}$	-55 to +150		°C

## SCHEMATIC DIAGRAM

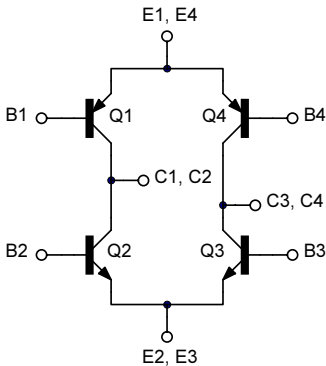

## CONNECTION DIAGRAM

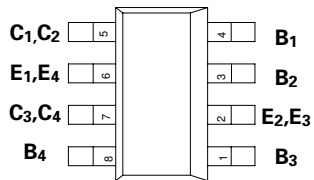

# ZHB6790

## THERMAL CHARACTERISTICS

PARAMETER	SYMBOL	VALUE	UNIT
Total Power Dissipation at $T_{amb} = 25^{\circ}\text{C}^*$ Any single transistor "on" Q1 and Q3 "on" or Q2 and Q4 "on" equally	$P_{tot}$	1.25 2	W W
Derate above $25^{\circ}\text{C}^*$ Any single transistor "on" Q1 and Q3 "on" or Q2 and Q4 "on" equally		10 16	mW/ $^{\circ}\text{C}$ mW/ $^{\circ}\text{C}$
Thermal Resistance - Junction to Ambient* Any single transistor "on" Q1 and Q3 "on" or Q2 and Q4 "on" equally		100 62.5	$^{\circ}\text{C}/\text{W}$ $^{\circ}\text{C}/\text{W}$

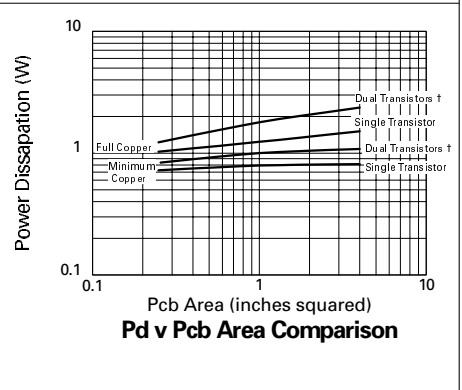
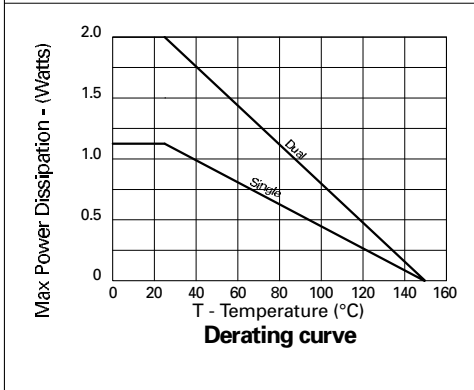
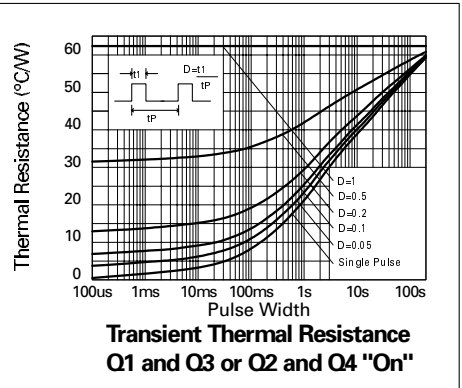
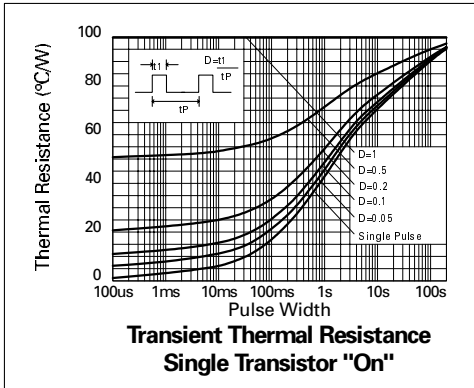

\* The power which can be dissipated assuming the device is mounted in a typical manner on a PCB with copper equal to 2 inches square.

† "Two devices on" is the standard operating condition for the bridge. Eg. opposing NPN/PNP pairs turned on.

# ZHB6790

## PNP TRANSISTORS ELECTRICAL CHARACTERISTICS (at $T_{amb} = 25^{\circ}\text{C}$ ).

PARAMETER	SYMBOL	MIN.	TYP.	MAX.	UNIT	CONDITIONS.
Collector-Base Breakdown Voltage	$V_{(BR)CBO}$	-50			V	$I_C = -100\mu\text{A}$
Collector-Emitter Breakdown Voltage	$V_{(BR)CEO}$	-40			V	$I_C = -10\text{mA}^*$
Emitter-Base Breakdown Voltage	$V_{(BR)EBO}$	-5			V	$I_E = -100\mu\text{A}$
Collector Cutoff Current	$I_{CBO}$			-0.1	$\mu\text{A}$	$V_{CB} = -30\text{V}$
Emitter Cutoff Current	$I_{EBO}$			-0.1	$\mu\text{A}$	$V_{EB} = -4\text{V}$
Collector-Emitter Saturation Voltage	$V_{CE(sat)}$			-0.14 -0.25 -0.45 -0.75	V	$I_C = -100\text{mA}, I_B = -0.5\text{mA}^*$ $I_C = -500\text{mA}, I_B = -5\text{mA}^*$ $I_C = -1\text{A}, I_B = -10\text{mA}^*$ $I_C = -2\text{A}, I_B = -50\text{mA}^*$
Base-Emitter Saturation Voltage	$V_{BE(sat)}$			-1.0	V	$I_C = -1\text{A}, I_B = -10\text{mA}^*$
Base-Emitter Turn-On Voltage	$V_{BE(on)}$		-0.75		V	$I_C = -1\text{A}, V_{CE} = -2\text{V}^*$
Static Forward Current Transfer Ratio	$h_{FE}$	300 200 150				$I_C = -100\text{mA}, V_{CE} = -2\text{V}$ $I_C = -1\text{A}, V_{CE} = -2\text{V}^*$ $I_C = -2\text{A}, V_{CE} = -2\text{V}^*$
Transition Frequency	$f_T$	100			MHz	$I_C = -50\text{mA}, V_{CE} = -5\text{V}$ $f = 50\text{MHz}$
Input Capacitance	$C_{ibo}$		225		pF	$V_{EB} = -0.5\text{V}, f = 1\text{MHz}$
Output Capacitance	$C_{obo}$		24		pF	$V_{CB} = -10\text{V}, f = 1\text{MHz}$
Switching Times	$t_{on}$ $t_{off}$		35 600		ns	$I_C = -500\text{mA},$ $I_{B1} = -50\text{mA}$ $I_{B2} = -50\text{mA}, V_{CC} = -10\text{V}$

\*Measured under pulsed conditions. Pulse width=300 $\mu\text{s}$ . Duty cycle  $\leq 2\%$ .

# ZHB6790

## NPN TRANSISTORS ELECTRICAL CHARACTERISTICS (at $T_{amb} = 25^{\circ}\text{C}$ ).

PARAMETER	SYMBOL	MIN.	TYP.	MAX.	UNIT	CONDITIONS.
Collector-Base Breakdown Voltage	$V_{(BR)CBO}$	50			V	$I_C=100\mu\text{A}$
Collector-Emitter Breakdown Voltage	$V_{(BR)CEO}$	40			V	$I_C=10\text{mA}^*$
Emitter-Base Breakdown Voltage	$V_{(BR)EBO}$	5			V	$I_E=100\mu\text{A}$
Collector Cutoff Current	$I_{CBO}$			0.1	$\mu\text{A}$	$V_{CB}=35\text{V}$
Emitter Cutoff Current	$I_{EBO}$			0.1	$\mu\text{A}$	$V_{EB}=4\text{V}$
Collector-Emitter Saturation Voltage	$V_{CE(sat)}$			0.1 0.16 0.5 0.35	V V V V	$I_C=100\text{mA}$ , $I_B=0.5\text{mA}^*$ $I_C=500\text{mA}$ , $I_B=2.5\text{mA}^*$ $I_C=1\text{A}$ , $I_B=5\text{mA}^*$ $I_C=2\text{A}$ , $I_B=30\text{mA}^*$
Base-Emitter Saturation Voltage	$V_{BE(sat)}$			0.9	V	$I_C=1\text{A}$ , $I_B=10\text{mA}^*$
Base-Emitter Turn-On Voltage	$V_{BE(on)}$		0.73		V	$I_C=1\text{A}$ , $V_{CE}=2\text{V}^*$
Static Forward Current Transfer Ratio	$h_{FE}$	500 400 150				$I_C=100\text{mA}$ , $V_{CE}=2\text{V}^*$ $I_C=1\text{A}$ , $V_{CE}=2\text{V}^*$ $I_C=2\text{A}$ , $V_{CE}=2\text{V}^*$
Transition Frequency	$f_T$	150			MHz	$I_C=50\text{mA}$ , $V_{CE}=5\text{V}$ $f=50\text{MHz}$
Input Capacitance	$C_{ibo}$		200		pF	$V_{EB}=0.5\text{V}$ , $f=1\text{MHz}$
Output Capacitance	$C_{obo}$		16		pF	$V_{CB}=10\text{V}$ , $f=1\text{MHz}$
Switching Times	$t_{on}$ $t_{off}$		33 1300		ns	$I_C=500\text{mA}$ , $I_{B1}=50\text{mA}$ $I_{B2}=50\text{mA}$ , $V_{CC}=10\text{V}$

\*Measured under pulsed conditions. Pulse width=300 $\mu\text{s}$ . Duty cycle  $\leq 2\%$ .

ZHB6790

# PNP TRANSISTOR TYPICAL CHARACTERISTICS

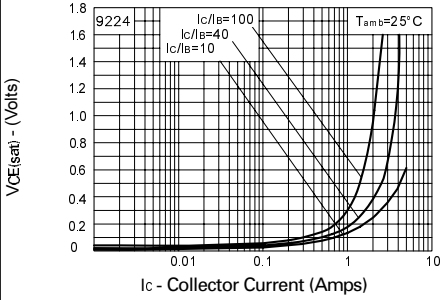

VCE(sat) v IC

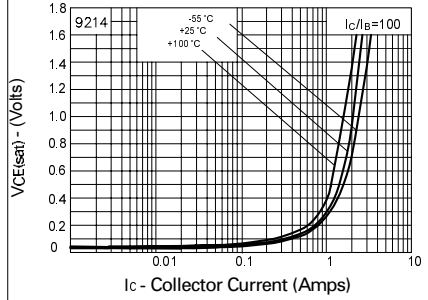

VCE(sat) v IC

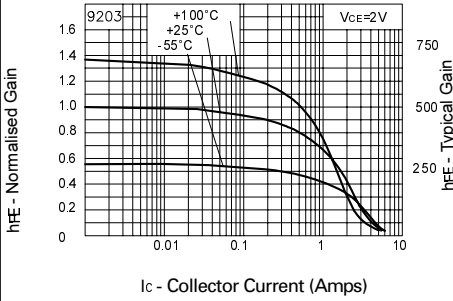

hFE v IC

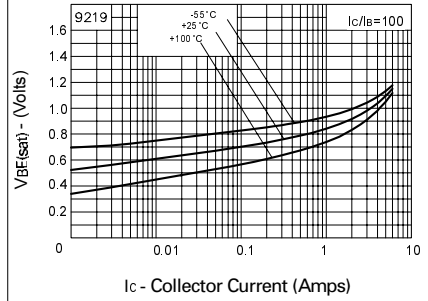

VBE(sat) v IC

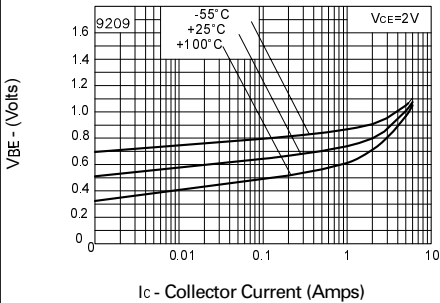

VBE(on) v IC

# ZHB6790

## NPN TRANSISTOR TYPICAL CHARACTERISTICS

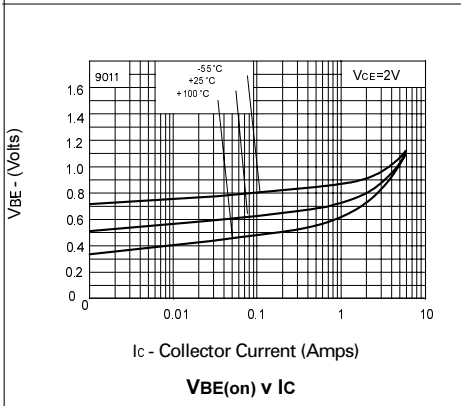
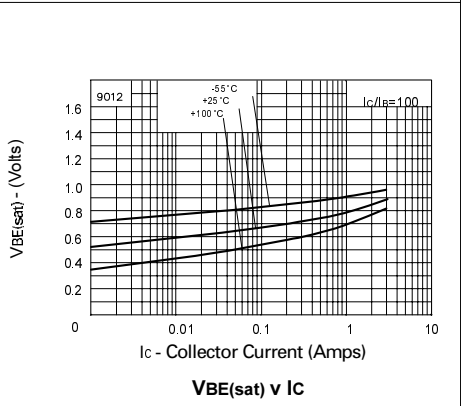
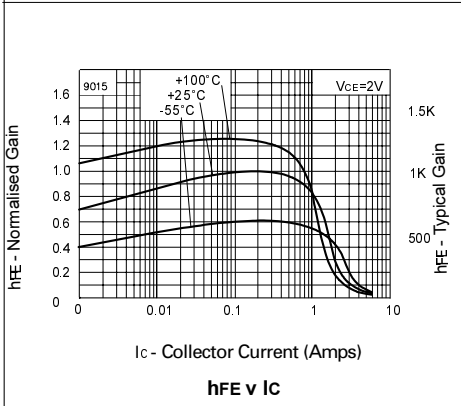
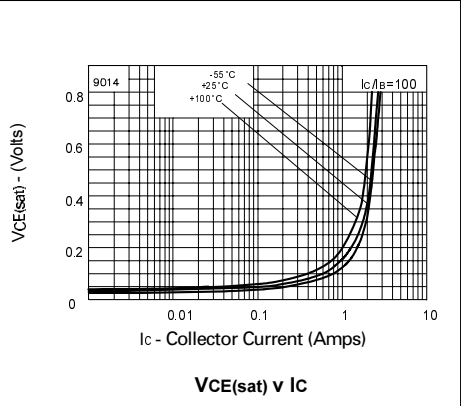
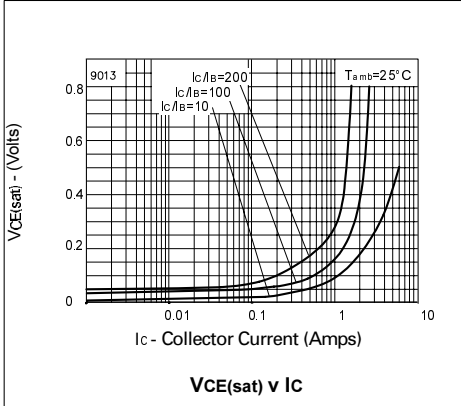

## SAFE OPERATING AREA

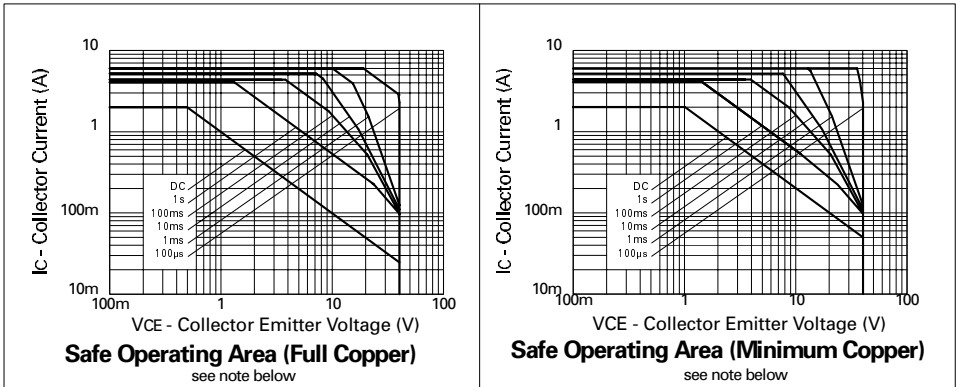

Note: The Safe Operating Area (SOA) charts shown are a combination of the worst case secondary breakdown characteristics for the NPN/PNP pair, and the thermal curves demonstrating the power dissipation capability of the energised ZHB part (opposing NPN-PNP switched on) when mounted on a 50mm x 50mm FR4 PCB. The two cases show:

- i) full copper present and
- ii) with minimal copper present - this being defined as an SM-8 footprint with 1.5mm tracks to the edge of the PCB.

For example, on a 50mm x 50mm full copper PCB, the ZHB6790 will safely dissipate 2W under DC conditions, taking note of continuous current ratings and voltage limits. Higher powers can be tolerated for pulsed operation, while the shorter pulse widths (100µs and 1ms) being relevant for assessment of switching conditions.

The ZHB6790 'H'-Bridge can be modelled within SPICE using the following transistor models configured in the standard 'H'-Bridge topology, as shown in the schematic diagram of this datasheet.

```
ZETEX H Bridge NPN transistors Spice model Last revision 4/7/97
.MODEL H6790N NPN IS=2.505E-12 NF=1.0058 BF=1360 IKF=1.3 VAF=35
+ISE=.24E-12 NE=1.38 NR=1.001 BR=125 IKR=1 VAR=8 ISC=.435E-12
+NC=1.213 RB=.2 RE=.043 RC=.04 CJC=54.3E-12 MJC=.475 VJC=.765
+CJE=247E-12 TF=.851E-9 TR=15.7E-9
```

\*

```
*ZETEX H Bridge PNP transistors Spice model Last revision 4/7/97
.MODEL H6790P PNP IS=1.09684E-12 NF=1.0102 BF=650 IKF=1.7 VAF=23.5
+ISE=9.88593E-14 NE=1.47256 NR=1.00391 BR=270 IKR=0.2 VAR=30
+ISC=5.4933E-14 NC=1.07427 RB=0.055 RE=0.049 RC=0.078 CJC=96E-12
+MJC=0.495 VJC=0.67 CJE=275E-12 TF=0.75E-9 TR=10.8E-9
```

\*

(C) 1997 ZETEX PLC

The copyright in these models and the design embodied belong to Zetex PLC ("Zetex"). They are supplied free of charge by Zetex for the purpose of research and design and may be used or copied intact (including this notice) for that purpose only. All other rights are reserved. The models are believed accurate but no condition or warranty as to their merchantability or fitness for purpose is given and no liability in respect of any use is accepted by Zetex PLC, its distributors or agents. Zetex PLC, Fields New Road, Chadderton,



# ZHB6790

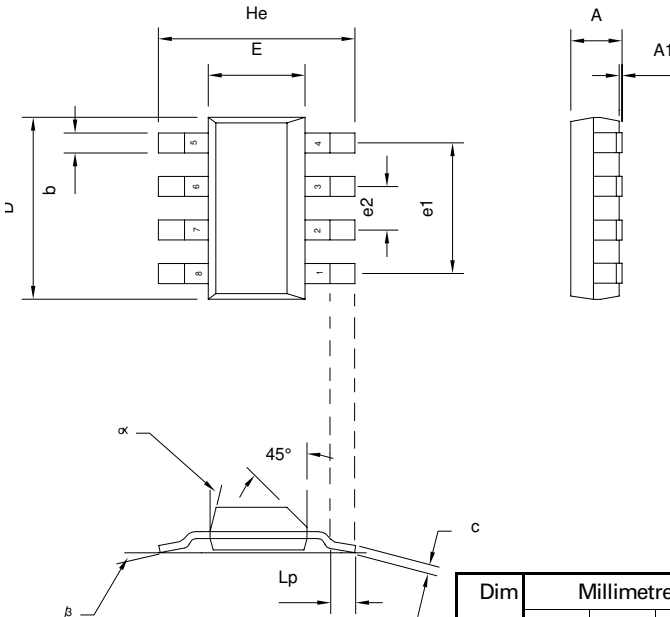

Dim	Millimetres			Inches		
	Min	Typ	Max	Min	Typ	Max
A	-	-	1.7	-	-	0.067
A1	0.02	-	0.1	0.0008	-	0.004
b	-	0.7	-	-	0.028	-
c	0.24	-	0.32	0.009	-	0.013
D	6.3	-	6.7	0.248	-	0.264
E	3.3	-	3.7	0.130	-	0.145
e1	-	4.59	-	-	0.180	-
e2	-	1.53	-	-	0.060	-
He	6.7	-	7.3	0.264	-	0.287
Lp	0.9	-	-	0.035	-	-

**ZETEX**

Zetex plc.  
Fields New Road, Chadderton, Oldham, OL9-8NP, United Kingdom.  
Telephone: (44)161 622 4422 (Sales), (44)161 622 4444 (General Enquiries)  
Fax: (44)161 622 4420

Zetex GmbH  
Streitfeldstraße 19  
D-81673 München  
Germany  
Telefon: (49) 89 45 49 49 0  
Fax: (49) 89 45 49 49 49

Zetex Inc.  
47 Mall Drive, Unit 4  
Commack NY 11725  
USA  
Telephone: (516) 543-7100  
Fax: (516) 864-7630

Zetex (Asia) Ltd.  
3510 Metroplaza, Tower 2  
Hing Fong Road,  
Kwai Fong, Hong Kong  
Telephone: (852) 26100 611  
Fax: (852) 24250 494

These are supported by  
agents and distributors in  
major countries world-wide  
©Zetex plc 1997  
**Internet:**  
<http://www.zetex.com>

This publication is issued to provide outline information only which (unless agreed by the Company in writing) may not be used, applied or reproduced for any purpose or form part of any order or contract or be regarded as a representation relating to the products or services concerned. The Company reserves the right to alter without notice the specification, design, price or conditions of supply of any product or service.