



Chipsmall Limited consists of a professional team with an average of over 10 year of expertise in the distribution of electronic components. Based in Hongkong, we have already established firm and mutual-benefit business relationships with customers from,Europe,America and south Asia,supplying obsolete and hard-to-find components to meet their specific needs.

With the principle of “Quality Parts,Customers Priority,Honest Operation,and Considerate Service”,our business mainly focus on the distribution of electronic components. Line cards we deal with include Microchip,ALPS,ROHM,Xilinx,Pulse,ON,Everlight and Freescale. Main products comprise IC,Modules,Potentiometer,IC Socket,Relay,Connector.Our parts cover such applications as commercial,industrial, and automotives areas.

We are looking forward to setting up business relationship with you and hope to provide you with the best service and solution. Let us make a better world for our industry!



Contact us

Tel: +86-755-8981 8866 Fax: +86-755-8427 6832

Email & Skype: info@chipsmall.com Web: www.chipsmall.com

Address: A1208, Overseas Decoration Building, #122 Zhenhua RD., Futian, Shenzhen, China





MeshConnect™ EM357 High Temp Mini Modules

ZICM357SP2-x-HT

Ember™ EM357 Transceiver Based Modules

Integrated Transceiver Modules for ZigBee/IEEE 802.15.4

DESCRIPTION

The MeshConnect™ EM357 High Temperature (High Temp) Mini Modules from California Eastern Laboratories (CEL) combine high performance RF solutions with the market's premier ZigBee® stack. Available in a high output power option (+20dBm), these modules can accommodate variable range and performance requirements. The tiny module footprint makes them suitable for a wide range of ZigBee applications. The MeshConnect EM357 High Temp Mini Modules are certified and qualified, enabling customers to accelerate time to market by greatly reducing the design and certification phases of development.

CEL's MeshConnect EM357 High Temp Mini Modules (ZICM357SP2-1-HT and ZICM357SP2-1C-HT) are based on the Ember EM357 Zigbee compliant SoC radio IC. The IC is a single-chip solution, compliant with ZigBee specifications and IEEE 802.15.4, a complete wireless solution for all ZigBee applications. The IC consists of an RF transceiver with the baseband modem, a hardwired MAC and an embedded 32-bit ARM® Cortex™-M3 microcontroller with internal RAM (12kB) and Flash (192kB) memory. The device provides numerous general-purpose I/O pins and peripheral functions such as timers and UARTs.

CEL's MeshConnect EM357 High Temp Mini Modules are suitable for applications such as solar and lighting controls where the temperature requirements may exceed the industrial range specs. The modules are designed and built using high temperature components to provide a robust solution without compromising performance.

CEL MeshConnect™ EM357 High Temp Mini Modules



Operating Temperature: -40 °C to 110 °C

- 192 kB FLASH
- 12 kB SRAM
- 32-bit ARM® Cortex™-M3
- Up to 23 GPIO Pins
- SPI (Master/Slave), TWI, UART
- Timers, Serial Wire/JTAG Interface
- 5-channel 14-bit ADC

ZICM357SP2-x-HT

Tx: +20 dBm
Rx: -103 dBm
Link Budget: +123 dB

FC IC RoHS

FEATURES

- **High RF Performance:**
 - Up to 123dB RF Link Budget
 - RX Sensitivity: -103 dBm
- **Data Rate: 250 kbps**
- **Advanced Cortex-M3 Processor**
- **Advanced Power Management**
- **16 RF Channels**
- **Industry's Premier ZigBee Pro Stack: EmberZNet PRO™**
- **Mini Footprint:**
 - 0.940" x 0.655" (23.9 mm x 16.6 mm)
- **Antenna Options**
 - 1) Integrated PCB Trace Antenna or
 - 2) RF Port for External Antenna
- **Supports Mesh Networks**
- **AES Encryption**
- **FCC and IC Certifications**
- **ROHS Compliant**

APPLICATIONS

- **Smart Energy/Grid Markets**
 - Thermostats
 - In-Home Displays
 - Smart Plugs
- **Home Automation and Control**
 - Energy Management
 - Security Devices
 - HVAC Control
- **Building Automation and Control**
- **Commercial and Residential Lighting**
 - Fixtures and Control
- **Solar Inverters and Control**
- **General ZigBee Wireless Sensor Networking**

TABLE OF CONTENTS

Introduction and Overview

Description..... 1
 Features..... 1
 Applications..... 1
 Ordering Information..... 3
 Module Block Diagram..... 3

System Level Function

Transceiver IC..... 4
 Antenna..... 4
 Power Amplifier..... 4
 High Temperature Output Power..... 5
 Software/Firmware..... 5

Electrical Specification

Absolute Maximum Ratings..... 6
 Recommended (Operating Condition)..... 6
 DC Characteristics..... 6
 RF Characteristics..... 6

Pin Signal and Interfaces

Pin Signals I/O Configuration..... 7
 I/O Pin Assignment..... 7
 Module Dimensions..... 9
 Module Land Footprint..... 10

Processing..... 11

Agency Certifications..... 13

Shipment, Storage and Handling..... 15

Quality..... 15

References..... 16

Revision History..... 16

ORDERING INFORMATION

Part Number	Order Number	Description	Min/Multiple
ZICM357SP2-x-HT	ZICM357SP2-1-HT	High Temperature , +20dBm Output Power, PCB Trace antenna; tray package	330/330
	ZICM357SP2-1-HT-R	High Temperature , +20dBm Output Power, PCB Trace antenna; tape and reel package	600/600
	ZICM357SP2-1C-HT	High Temperature, +20dBm Output Power, with Castellations pin for external antenna; tray package	330/330
	ZICM357SP2-1C-HT-R	High Temperature, +20dBm Output Power, with Castellations pin for external antenna; tape and reel package	600/600

Note: All packages come in Trays unless a part number has a "-R" designation; part numbers with the "-R" indicate a Tape and Reel Package Option.

MODULE BLOCK DIAGRAM

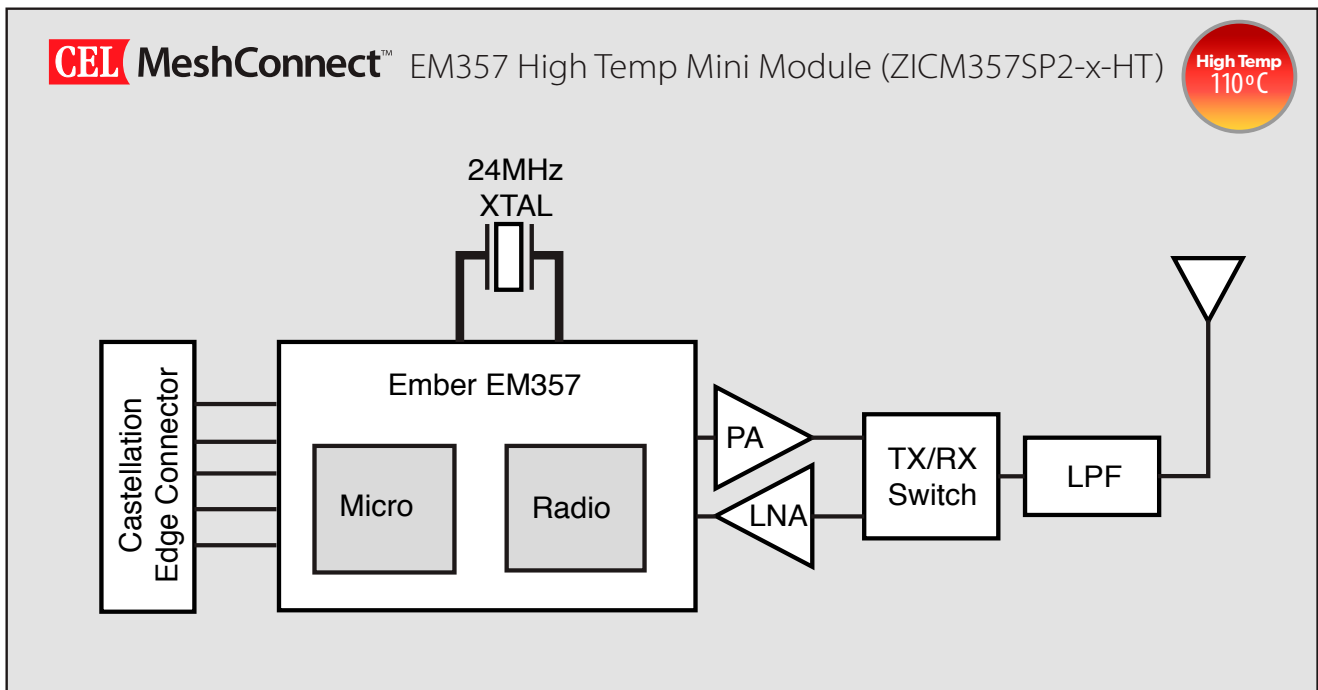

TRANSCEIVER IC

CEL's MeshConnect EM357 High Temp Mini Modules use the Ember EM357 transceiver IC. This IC incorporates the RF transceiver with the baseband modem, a hardwired MAC, and an embedded ARM® Cortex™-M3 microcontroller, offering an excellent low cost high performance solution for all IEEE 802.15.4/ZigBee applications. For more information about the EM357 IC, visit www.silabs.com.

ANTENNA

CEL's MeshConnect EM357 High Temp Mini Modules include an integrated Printed Circuit Board (PCB) trace antenna. An optional configuration which uses a castellation pin on the module allows the user to connect an external antenna. The ZICM357SP2-x-HT has been certified with the PCB trace antenna and a Nearson half-wave dipole antenna (part number: S181AH-2450S) on a 4 inch cable using the castellation pin of the module. Please refer to the document *ZICM357SP2-1C External Antenna Implementation* for details describing the requirements that must be followed to take advantage of the CEL certification.

The PCB antenna employs a topology that is compact and highly efficient. To maximize range, an adequate ground plane must be provided on the host PCB. Correctly positioned, the ground plane on the host PCB will contribute significantly to the antenna performance (it should not be directly under the module PCB Antenna). The position of the module on the host board and overall design of the product enclosure contribute to antenna performance. Poor design affects radiation patterns and can result in reflection, diffraction and/or scattering of the transmitted signal.

For optimum antenna performance, the MeshConnect Modules should be mounted with the PCB trace antenna overhanging the edge of the host board. To further improve performance, a ground plane should be placed on the host board under the module, up to the antenna (a minimum of 1.5" x 1.5" is recommended). The installation of an uninterrupted ground plane on a layer directly beneath the module will also allow you to run traces under this layer. CEL can provide assistance with your PCB layout.

The following are some design guidelines to help ensure antenna performance:

- Never place the ground plane or route copper traces directly underneath the antenna portion of the module
- Never place the antenna close to metallic objects
- In the overall design, ensure that wiring and other components are not placed near the antenna
- Do not place the antenna in a metallic or metalized plastic enclosure
- Keep plastic enclosures 1 cm or more away from the antenna in any direction

Under Industry Canada regulations, this radio transmitter may only operate using an antenna of a type and maximum (or lesser) gain approved for the transmitter by Industry Canada. To reduce potential radio interference to other users, the antenna type and its gain should be so chosen that the equivalent isotropically radiated power (e.i.r.p.) is not more than that necessary for successful communication.

Conformément à la réglementation d'Industrie Canada, le présent émetteur radio peut fonctionner avec une antenne d'un type et d'un gain maximal (ou inférieur) approuvé pour l'émetteur par Industrie Canada. Dans le but de réduire les risques de brouillage radioélectrique à l'intention des autres utilisateurs, il faut choisir le type d'antenne et son gain de sorte que la puissance isotrope rayonnée équivalente (p.i.r.e.) ne dépasse pas l'intensité nécessaire à l'établissement d'une communication satisfaisante.

POWER AMPLIFIER

CEL's MeshConnect EM357 High Temp Mini Module (ZICM357SP2-x-HT) includes a Power Amplifier (PA). This PA delivers high efficiency, high gain, and high output power ($P_{out} = +20.0\text{dBm}$ TYP) to provide an extended range and reliable transmission for fewer nodes in a network. For the ZICM357SP2-x-HT, Power Mode 2 with Power Setting -2 is the maximum setting allowed for FCC compliance at 25°C. Operating in Power Mode 3 at higher power settings may damage the PA.

HIGH TEMPERATURE OUTPUT POWER

FCC restrictions require the output power to be maintained below 21dBm which corresponds to Power Setting -2 at 25 °C. For those applications requiring the maximum output power at 110 °C, the power setting can be increased up to Power Setting 6 when operated at elevated temperatures. One method of implementation would be to create a look-up table for Power Setting versus temperature which the firmware would use to control the output power. This would require the host board to implement a temperature sensing circuit and the ability of the module to have access to the temperature such as using a temperature sensing IC connected to one of the module analog inputs.

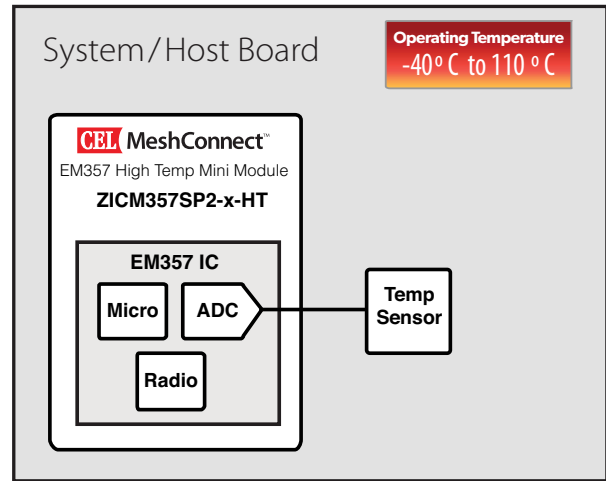

SOFTWARE / FIRMWARE

CEL's MeshConnect EM357 High Temp Mini Modules are ideal platforms for EmberZNet PRO™, the industry's most deployed and field proven ZigBee compliant stack supporting the ZigBee PRO feature Set. EmberZNet PRO is a complete ZigBee protocol software package containing all the elements required for mesh networking applications. For more information regarding the software development for this IC, visit www.silabs.com.

CEL provides reference software that runs multiple functions and executes various commands. The firmware allows the execution of IEEE 802.15.4 communication, validation and manufacturing tests. For example, users can setup a simple ZigBee Point-to-Point network to perform Range and Packet Error Rate (PER) tests. The software can also place the module in various operating modes, which allows for setting and/or testing various parameters.

The ZICM357SP2-x-HT uses the transceiver's Alternate RF ports for transmitting and should use Power Mode 2.

ABSOLUTE MAXIMUM RATINGS

Description	MeshConnect EM357 High Temp Mini Module		Unit
	Min	Max	
Power Supply Voltage (VDD)	-0.3	3.6	VDC
Voltage on any I/O Line	-0.3	VDD + 0.3	VDC
RF Input Power	-	+5	dBm
Storage Temperature Range	-40	125	°C
Reflow Soldering Temperature	-	260	°C

Note: Exceeding the maximum ratings may cause permanent damage to the module or devices.

RECOMMENDED (OPERATING CONDITIONS)

Description	MeshConnect EM357 High Temp Mini Module			Unit
	Min	Typ	Max	
Power Supply Voltage (VDD)	2.1	3.0	3.6	VDC
Input Frequency	2405	-	2480	MHz
Ambient Temperature Range	-40	25	110	°C

DC CHARACTERISTICS (@ 25° C, VDD = 3.0V, ZICM357SP2-x-HT TX Power Mode 2)

Description		MeshConnect EM357 High Temp Mini Module			Unit
		Min	Typ	Max	
Transmit Current @ 25° C, 19dBm	ZICM357SP2-x-HT	-	150	-	mA
Transmit Current @ -40° C, 20dBm		-	160	-	mA
Transmit Current @ 110° C, 19dBm		-	175	-	mA
Receive Current over Temperature		-	34	-	mA
Sleep Mode Current		-	1	-	µA

RF CHARACTERISTICS (@ 25° C, VDD = 3.0V, ZICM357SP2-x-HT TX Power Mode 2)

Description		MeshConnect EM357 High Temp Mini Module			Unit
		Min	Typ	Max	
General Characteristics					
RF Frequency Range	ZICM357SP2-x-HT	2405	-	2480	MHz
RF Channels		11	-	26	-
Frequency Error Tolerance		-96.2	-	96.2	kHz
Transmitter					
Output Power @ 25° C (using Power Mode 2, Power Setting -2)	ZICM357SP2-x-HT	-	19	-	dBm
Output Power @ -40° C (using Power Mode 2, Power Setting -2)		-	20	-	dBm
Output Power @ 110° C (using Power Mode 2, Power Setting 6)		-	19	-	dBm
Minimum Output Power		-	-40	-	dBm
Offset Error Vector Magnitude		-	5	35	%
Receiver					
Sensitivity (1% PER, normal mode)	ZICM357SP2-x-HT	-	-103	-97	dBm
Saturation (maximum input level)		-10	-	-	dBm

Note: For the ZICM357SP2-x-HT Module, Power Mode 2 with Power Setting -2 is the maximum setting allowed for FCC Compliance. Operating in Power Mode 3 at higher power settings may damage the PA.

PIN SIGNALS I/O PORT CONFIGURATION

CEL's MeshConnect Module has 33 edge I/O interfaces for connection to the user's host board. The MeshConnect Module Dimensions shows the layout of the 33 edge castellations.

MESHCONNECT I/O PIN ASSIGNMENTS

CEL MeshConnect ZICM357SP2-x-HT Module Pin Number	Ember EM357 IC Pin Number	Name	Notes
1, 2, 12, 31, 33	49	GROUND	
3	11	PC5	<i>PC5 is not connected to a castellation pin, but is used internally within the module as the TX_ACTIVE signal</i>
4	12	RESET	Active Low chip reset (Input)
5	13	PC6	Digital I/O OSC32B - 32.768 kHz crystal oscillator nTX_ACTIVE - Inverted TX_ACTIVE signal
6	14	PC7	Digital I/O OSC32A - 32.768 kHz crystal oscillator OSC32_EXT - Digital 32.768 kHz clock input source
7	18	PA7	Digital I/O TIM1C4 - Timer 1 Channel 4 input/output REG_EN - External regulator open drain output
8	19	PB3	Digital I/O TIM2C3 - Timer 2 Channel 3 input/output SC1nCTS - UART CTS handshake of Serial Controller 1 SC1SCLK - SPI master/slave clock of Serial Controller 1
9	20	PB4	Digital I/O TIM2C4 - Timer 2 Channel 4 input/output SC1nRTS - UART RTS handshake of Serial Controller 1 SC1nSSEL - SPI slave select of Serial Controller 1
10	21	PA0	Digital I/O TIM2C1 - Timer 2 Channel 1 input/output SC2MOSI - SPI master data out/slave data in of Serial Controller 2
11	22	PA1	Digital I/O TIM2C3 - Timer 2 Channel 3 input/output SC2SDA - TWI data of Serial Controller 2 SC2MISO - SPI master data in/slave data out of Serial Controller 2
13	16, 23, 28, 37	Vcc	
14	24	PA2	Digital I/O TIM2C4 - Timer 2 Channel 4 input/output SC2SCL - TWI clock of Serial Controller 2 SC2SCLK - SPI master/slave clock of Serial Controller 2
15	25	PA3	Digital I/O TIM2C2 - Timer 2 channel 2 input/output SC2nSSEL - SPI slave select of Serial Controller 2 TRACECLK - Synchronous CPU trace clock
16	26	PA4	Digital I/O ADC4 - ADC Input 4 PTI_EN - Frame signal of Packet Trace Interface (PTI) TRACEDATA2 - Synchronous CPU trace data bit 2
17	27	PA5	Digital I/O ADC5 - ADC Input 5 PTI_DATA - Data signal of Packet Trace Interface (PTI) nBOOTMODE - Embedded serial bootloader activation out of reset TRACEDATA3 - Synchronous CPU trace data bit 3
18	29	PA6	Digital I/O TIM1C3 - Timer 1 channel 3 input/output

MESHCONNECT I/O PIN ASSIGNMENTS (Continued)

CEL MeshConnect ZICM357SP2-x-HT Module Pin Number	Ember EM357 IC Pin Number	Name	Notes
19	30	PB1	Digital I/O SC1MISO - SPI slave data out of Serial Controller 1 SC1MOSI - SPI master data out of Serial Controller 1 SC1SDA - TWI data of Serial Controller 1 SC1TXD - UART transmit data of Serial Controller 1 TIM2C1 - Timer 2 channel 1 input/output
20	31	PB2	Digital I/O SC1MISO - SPI master data in of Serial Controller 1 SC1MOSI - SPI slave data in of Serial Controller 1 SC1SCL - TWI clock of Serial Controller 1 SC1RXD - UART receive data of Serial Controller 1 TIM2C2 - Timer 2 channel 2 input/output
21	32	JTCK	JTAG clock input from debugger SWCLK - Serial Wire clock input/output with debugger
22	33	PC2	Digital I/O JTD0 - JTAG data out to debugger SWO - Serial Wire Output asynchronous trace output to debugger
23	34	PC3	Digital I/O JTDI - JTAG data in from debugger
24	35	PC4	Digital I/O JTMS - JTAG mode select from debugger SWDIO - Serial Wire bidirectional data to/from debugger
25	36	PB0	Digital I/O VREF - ADC reference input/output IRQA - External interrupt source A TRACECLK - Synchronous CPU trace clock TIM1CLK - Timer 1 external clock input TIM2MSK - Timer 2 external clock mask input
26	38	PC1	Digital I/O ADC3 - ADC Input 3 SWO - Serial Wire Output asynchronous trace output to debugger TRACEDATA0 - Synchronous CPU trace data bit 0
27	40	PC0	Digital I/O JRST - JTAG reset input from debugger IRQD - Default external interrupt source D TRACEDATA1 - Synchronous CPU trace data bit 1
28	41	PB7	Digital I/O ADC2 - ADC Input 2 IRQC - Default external interrupt source C TIM1C2 - Timer 1 channel 2 input/output
29	42	PB6	Digital I/O ADC1 - ADC Input 1 IRQB - External interrupt source B TIM1C1 - Timer 1 channel 1 input/output
30	43	PB5	Digital I/O ADC0 - ADC Input 0 TIM2CLK - Timer 2 external clock input TIM1MSK - Timer 1 external clock mask input
32	NC	RF Out	Castellation Pin for external Antenna

MODULE DIMENSIONS

MeshConnect EM357 High Temp Mini Modules.

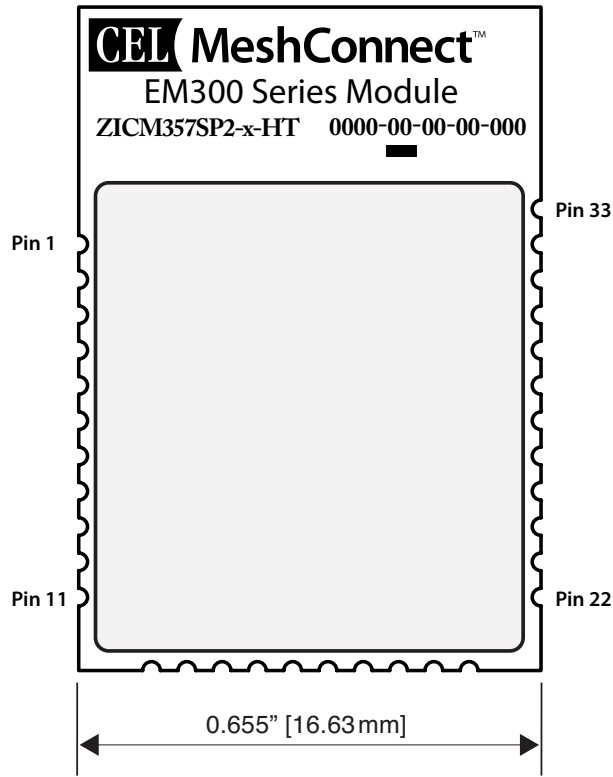

TOP VIEW

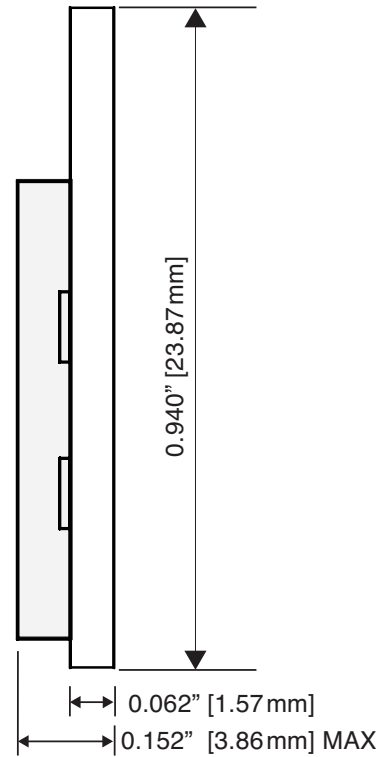

SIDE VIEW

Note: All dimensions are +/- 0.005" (0.12 mm) unless otherwise specified.

MODULE LAND FOOTPRINT

Dimensions are shown in inches, with millimeter conversions in brackets.

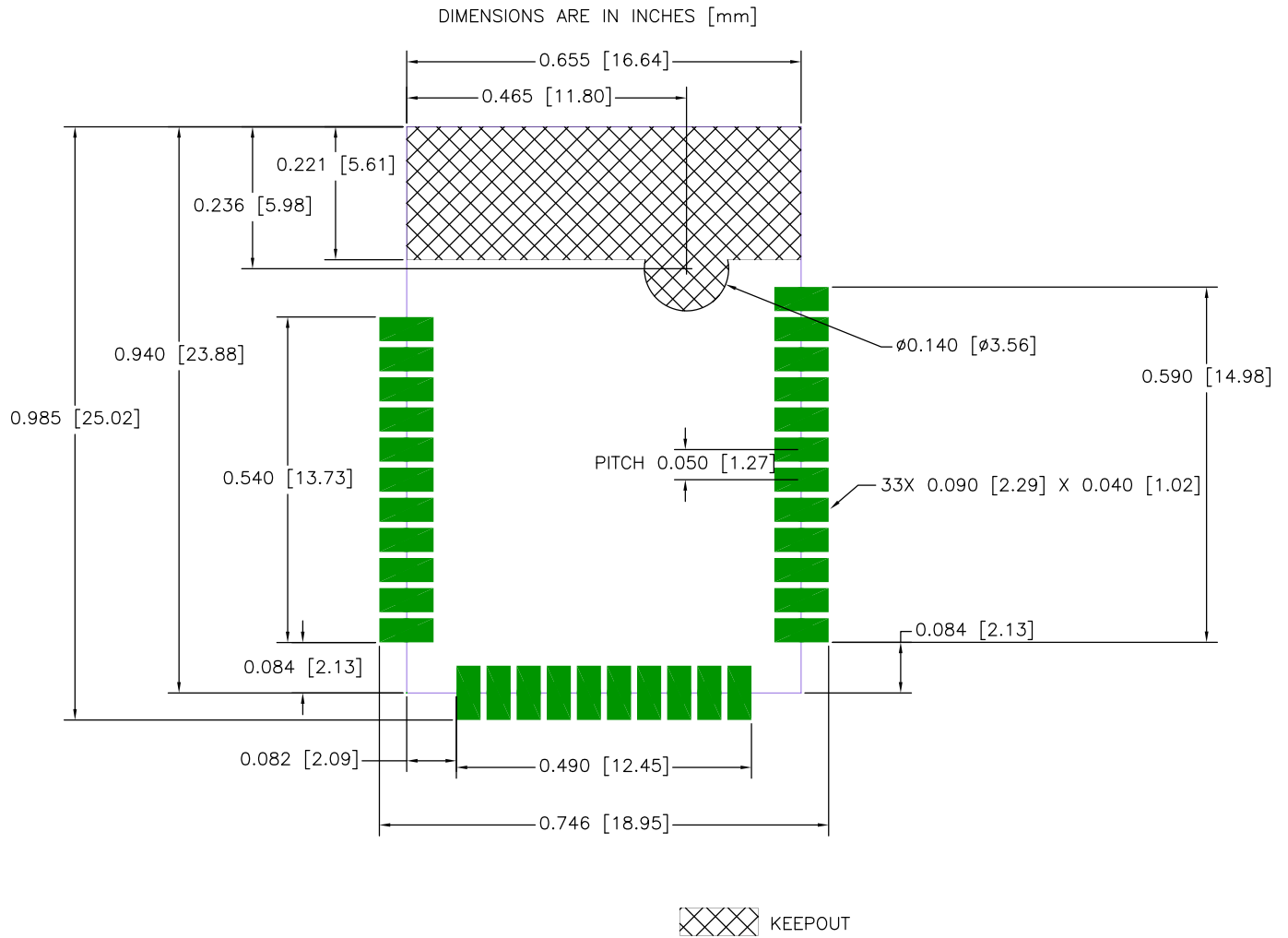

Note: Refer to the Antenna Section in this document for layout recommendations which will yield optimal antenna performance.

PROCESSING

Recommended Reflow Profile

Parameter Values	
Ramp up rate (from T _{soakmax} to T _{peak})	3°/sec max
Minimum Soak Temperature	150°C
Maximum Soak Temperature	200°C
Soak Time	60-120 sec
T _{Liquidus}	217°C
Time above T _{Liquidus}	60-150 sec
T _{peak}	250°C
Time within 5° of T _{peak}	20-30 sec
Time from 25° to T _{peak}	8 min max
Ramp down rate	6°C/sec max

Pb-Free Solder Paste

Use of “No Clean” soldering paste is strongly recommended, as it does not require cleaning after the soldering process.

Note: The quality of solder joints on the castellations (“half vias”) where they contact the host board should meet the appropriate IPC Specification. See the Castellated Terminations Section in the latest IPC-A-610 Acceptability of Electronic Assemblies document.

Cleaning

In general, cleaning the populated module is strongly discouraged. Residuals under the module cannot be easily removed with any cleaning process.

- Cleaning with water can lead to capillary effects where water is absorbed into the gap between the host board and the module. The combination of soldering flux residuals and encapsulated water could lead to short circuits between neighboring pads. Water could also damage any stickers or labels.
- Cleaning with alcohol or a similar organic solvent will likely flood soldering flux residuals into the two housings, which is not accessible for post-washing inspection. The solvent could also damage any stickers or labels.
- Ultrasonic cleaning could damage the module permanently.

The best approach is to consider using a “No Clean” solder paste and eliminate the post-soldering cleaning step.

Optical Inspection

After soldering the module to the host board, consider optical inspection to check the following:

- Proper alignment and centering of the module over the pads
- Proper solder joints on all pads
- Excessive solder or contacts to neighboring pads or vias

Repeating Reflow Soldering

Only a single reflow soldering process is encouraged for host boards.

Wave Soldering

If a wave soldering process is required on the host boards due to the presence of leaded components, only a single wave soldering process is encouraged.

Hand Soldering

Hand soldering is possible. When using a soldering iron, follow IPC recommendations (reference document *IPC-7711*).

Rework

The MeshConnect Module can be unsoldered from the host board. Use of a hot air rework tool should be programmable and the solder joint and module should not exceed the maximum peak reflow temperature of 250°C.

Caution

If temperature ramps exceed the reflow temperature profile, module and component damage may occur due to thermal shock. Avoid overheating.

Warning

Never attempt a rework on the module itself (i.e., replacing individual components); such actions will terminate warranty coverage.

Additional Grounding

Attempts to improve the module or the system grounding by soldering braids, wires or cables onto the module RF shield cover is done at the customer's own risk. The ground pins at the module perimeter should be sufficient for optimum immunity to external RF interference.

AGENCY CERTIFICATIONS

The following Part Numbers are Certified as shown below:

Part Number	Certifications	Antenna
ZICM357SP2-1-HT	FCC, IC	PCB
ZICM357SP2-1C-HT	FCC, IC	Nearson S181AH-2450S

FCC Compliance Statement Part 15.19, Section 7.15 of RSS-GEN

This device complies with Part 15 of the FCC Rules and with Industry Canada licence-exempt RSS Standards. Operation is subject to the following two conditions:

1. This device may not cause harmful interference, and
2. This device must accept any interference received, including interference that may cause undesired operation.

Le présent appareil est conforme aux CNR d'Industrie Canada applicables aux appareils radio exempts de licence. L'exploitation est autorisée aux deux conditions suivantes:

1. l'appareil ne doit pas produire de brouillage, et
2. l'utilisateur de l'appareil doit accepter tout brouillage radioélectrique subi, même si le brouillage est susceptible d'en compromettre le fonctionnement.

Warning (Part 15.21)

Changes or modifications not expressly approved by CEL could void the user's authority to operate the equipment.

20cm Separation Distance

To comply with FCC/IC RF exposure limits for general population/uncontrolled exposure, the antenna(s) used for this transmitter must be installed to provide a separation distance of at least 20 cm from all persons and must not be co-located or operated in conjunction with any other antenna or transmitter.

OEM Responsibility to the FCC and IC Rules and Regulations

The MeshConnect High Temp Mini Module has been certified per FCC Part 15 Rules and to Industry Canada license-exempt RSS Standards for integration into products without further testing or certification. To fulfill the FCC and IC Certification requirements, the OEM of the MeshConnect Module must ensure that the information provided on the MeshConnect label is placed on the outside of the final product. The MeshConnect High Temp Mini Module is labeled with its own FCC ID Number and IC ID Number. If the FCC ID and the IC ID are not visible when the module is installed inside another device, then the outside of the device into which the module is installed must also display a label referring to the enclosed module. The exterior label can use wording such as the following:

- “Contains Transmitter Module FCC ID: W7Z-ZICM357SP2” or “Contains FCC ID: W7Z-ZICM357SP2”
- “Contains Transmitter Module IC: 8254A-ZICM357SP2” or “Contains IC: 8254A-ZICM357SP2”

The OEM of the MeshConnect High Temp Mini Module may only use the approved antennas (PCB Trace Antenna and external antenna (part number: S181AH-2450S)) that have been certified with this module. The OEM of the MeshConnect High Temp Mini Module must test their final product configuration to comply with Unintentional Radiator Limits before declaring FCC Compliance per Part 15 of the FCC Rules.

IC Certification — Industry Canada Statement

The term "IC" before the certification/registration number only signifies that the Industry Canada technical specifications were met.

Certification IC — Déclaration d'Industrie Canada

Le terme "IC" devant le numéro de certification/d'enregistrement signifie seulement que les spécifications techniques Industrie Canada ont été respectées.

Section 14 of RSS-210

The installer of this radio equipment must ensure that the antenna is located or pointed such that it does not emit RF field in excess of Health Canada limits for the general population. Consult Safety Code 6, obtainable from Health Canada's website: http://www.hc-sc.gc.ca/ewh-semt/pubs/radiation/radio_guide-lignes_direct-eng.php

L'article 14 du CNR-210

Le programme d'installation de cet équipement radio doit s'assurer que l'antenne est située ou orientée de telle sorte qu'il ne pas émettre de champ RF au-delà des limites de Santé Canada pour la population générale. Consulter le Code de sécurité 6, disponible sur le site Web de Santé Canada: http://www.hc-sc.gc.ca/ewh-semt/pubs/radiation/radio_guide-lignes_direct-eng.php

Software Compliance

The MeshConnect High Temp Mini Modules require software restrictions to meet agency certification requirements. These restrictions have been implemented in the sample application included with the Software Development Kit.

If a customer is not starting with the CEL Software Development Kit, they must implement the following output power restrictions to use the FCC, IC or CE Certifications:

	Certification	RF Channel	Valid TX Power Steps @ 25°C	Typical Max Output Power
ZICM357SP2-1-HT	FCC/IC	11 - 24	-43 to -2	20dBm
		25	-43 to -6	17 dBm
		26	-43 to -26	-3dBm
ZICM357SP2-1C-HT	FCC/IC	11 - 24	-43 to -2	20dBm
		25	-43 to -12	9dBm
		26	-43 to -38	-5dBm

Note: The ZICM357SP2-x-HT, Power Mode 2 with Power Setting -2 is the maximum setting @ 25°C allowed for FCC Compliance. Operating in Power Mode 3 at higher power settings may damage the PA

SHIPMENT, HANDLING AND STORAGE

Shipment

The MeshConnect Modules have two delivery options (see Ordering Information on page 3):

1. Trays (in bundles) of 330 units. Each tray contains 66 units
2. Tape and Reel for easy assembly in a manufacturing environment. The reel diameter is 12.992 inches (330mm) and contains 600 modules

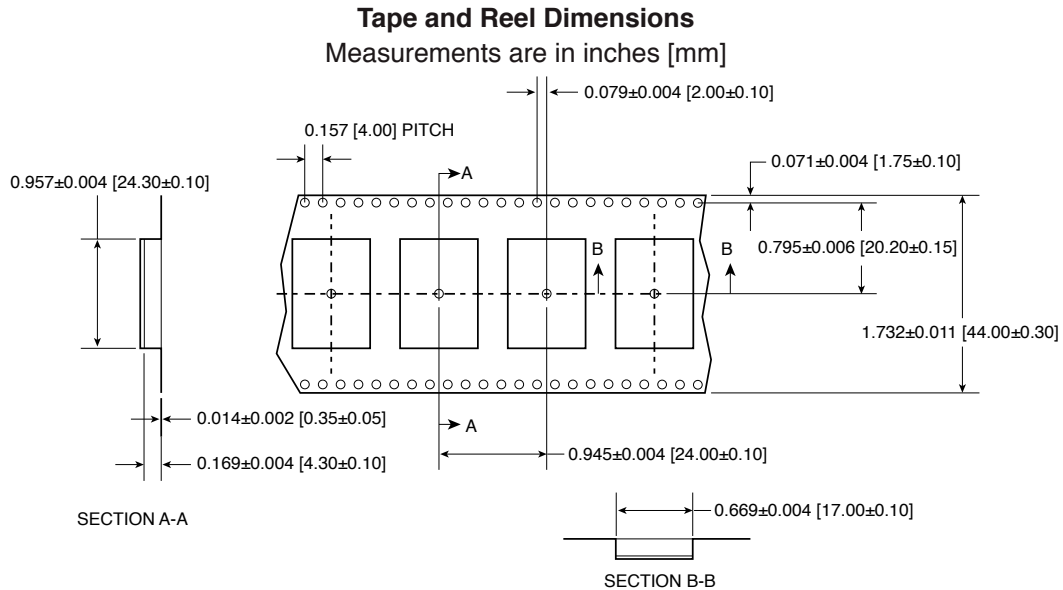

Handling

The MeshConnect Modules are designed and packaged to be processed in an automated assembly line.

Warning

The MeshConnect Modules contain highly sensitive electronic circuitry. Handling without proper ESD protection may destroy or damage the module permanently.

Warning

The MeshConnect Modules are moisture-sensitive devices. Appropriate handling instructions and precautions are summarized in J-STD-033. Read carefully to prevent permanent damage due to moisture intake.

Moisture Sensitivity Level (MSL)

MSL 3, per J-STD-033

Storage

Storage/shelf life in sealed bags is 12 months at <40°C and <90% relative humidity.

QUALITY

CEL Modules offer the highest quality at competitive prices. Our modules are manufactured in compliance with the IPC-A-610 specification, Class II. Our modules go through JESD22 qualification processes which include high temperature operating life tests, mechanical shock, temperature cycling, humidity and reflow testing. CEL conducts RF and DC factory testing on 100% of all production parts.

CEL builds the quality into our products, giving our customers confidence when integrating our products into their systems.

REFERENCES

Reference Documents	Download
120-035X-000 - Silicon Labs/Ember EM35x SoC Datasheet	Link
0011-02-17-00-000 - CEL EM35x Ember Mini Module Companion Kit Technical User Guide	Link
0011-00-16-11-000 - CEL ZICM357SP2-1C External Antenna Implementation	Link

REVISION HISTORY

Previous Versions	Changes to Current Version	Page(s)
0011-00-07-02-000 (Issue A) October 9, 2013	Initial preliminary datasheet	N/A

Disclaimer

The information in this document is current as of the published date. The information is subject to change without notice. For actual design-in, refer to the latest publications of CEL Data Sheets or Data Books, etc., for the most up-to-date specifications of CEL products. Not all products and/or types are available in every country. Please check with an CEL sales representative for availability and additional information.

No part of this document may be copied or reproduced in any form or by any means without the prior written consent of CEL. CEL assumes no responsibility for any errors that may appear in this document.

CEL does not assume any liability for infringement of patents, copyrights or other intellectual property rights of third parties by or arising from the use of CEL products listed in this document or any other liability arising from the use of such products. No license, express, implied or otherwise, is granted under any patents, copyrights or other intellectual property rights of CEL or others.

Descriptions of circuits, software and other related information in this document are provided for illustrative purposes in semiconductor product operation and application examples. The incorporation of these circuits, software and information in the design of a customer's equipment shall be done under the full responsibility of the customer. CEL assumes no responsibility for any losses incurred by customers or third parties arising from the use of these circuits, software and information.

While CEL endeavors to enhance the quality, reliability and safety of CEL products, customers agree and acknowledge that the possibility of defects thereof cannot be eliminated entirely. To minimize risks of damage to property or injury (including death) to persons arising from defects in CEL products, customers must incorporate sufficient safety measures in their design, such as redundancy, fire-containment and anti-failure features.

For More Information

For more information about CEL MeshConnect products and solutions, visit our website at:

www.cel.com/MeshConnect.

Technical Assistance

For Technical Assistance, visit www.cel.com/MeshConnectHelp.