



Chipsmall Limited consists of a professional team with an average of over 10 year of expertise in the distribution of electronic components. Based in Hongkong, we have already established firm and mutual-benefit business relationships with customers from,Europe,America and south Asia,supplying obsolete and hard-to-find components to meet their specific needs.

With the principle of "Quality Parts,Customers Priority,Honest Operation,and Considerate Service",our business mainly focus on the distribution of electronic components. Line cards we deal with include Microchip,ALPS,ROHM,Xilinx,Pulse,ON,Everlight and Freescale. Main products comprise IC,Modules,Potentiometer,IC Socket,Relay,Connector.Our parts cover such applications as commercial,industrial, and automotives areas.

We are looking forward to setting up business relationship with you and hope to provide you with the best service and solution. Let us make a better world for our industry!



Contact us

Tel: +86-755-8981 8866 Fax: +86-755-8427 6832

Email & Skype: info@chipsmall.com Web: www.chipsmall.com

Address: A1208, Overseas Decoration Building, #122 Zhenhua RD., Futian, Shenzhen, China



OMRON

NEW

Digital Bar Ionizer
ZJ-BAS

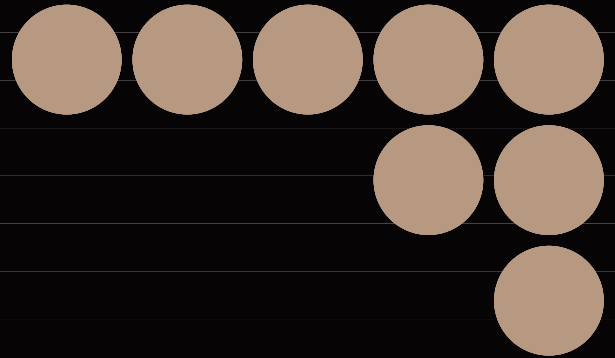

Effective and Efficient Ionization



realizing



Effective and Efficient Ionization

The highest level of ionization in its class.

Advanced Features in 3 Aspects

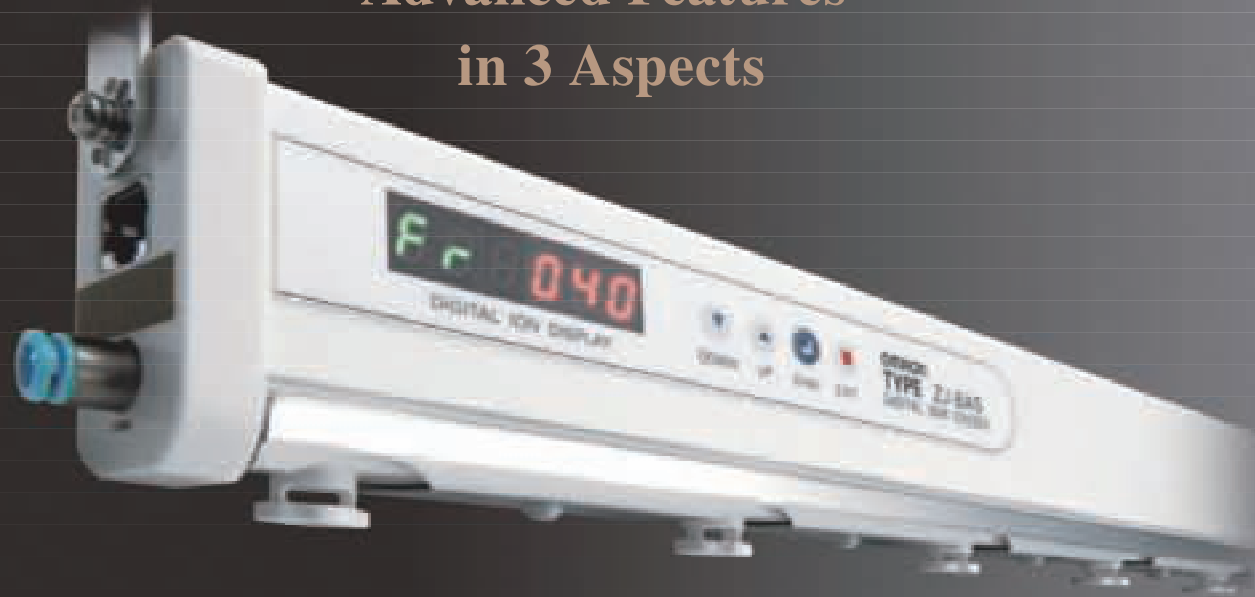

[Wide Area]

Ionizes areas wider than the ionizer itself.

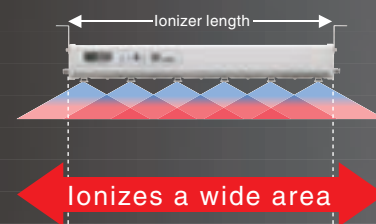

[Short Distance]

Achieves the highest level of short-distance ionization in its class.

■ Installation distance: 50 mm

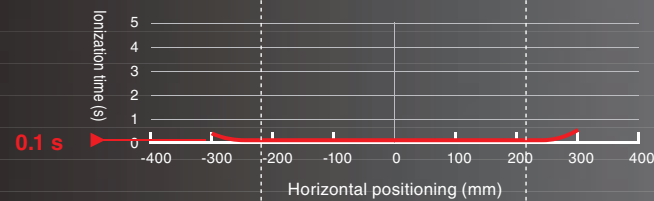

[Long Distance]

Steady ionizing performance, even over long distances.

■ Installation distance: 1,500 mm

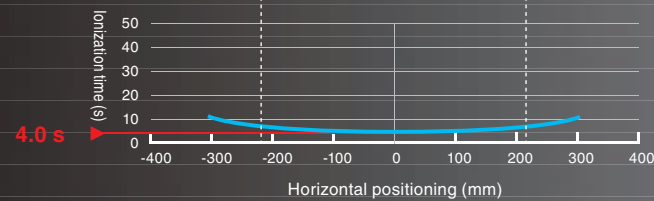

Three Technologies Supporting Effective and Efficient Ionization

Industry First

Technology 1 Ion Sensing and Variable-AC System

An ion sensor installed on the bottom of the ionizer detects the charge and ion balance. The applied voltage is flexibly controlled according to the ion balance conditions to raise ionization efficiency.

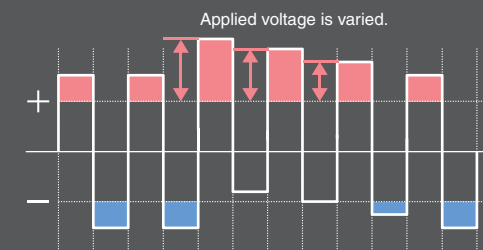

Technology 2 Micro Power Spraying (MPS) Structure

High-speed airflow is achieved by minimizing the air nozzle diameter. An optimal cone shape is also employed for the inside of the nozzle to further improve ion dispersion. By using a special ring guard shape to pull passive air into the active air stream, the total airflow is dramatically increased.

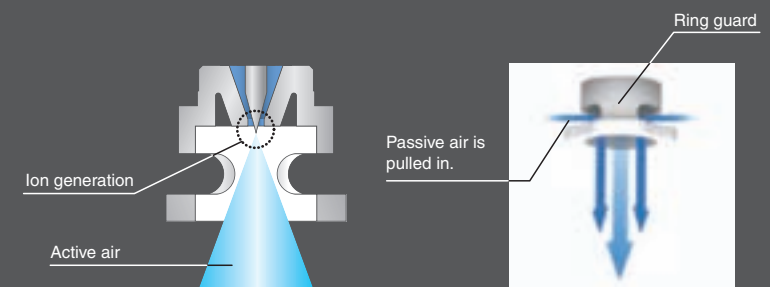

Technology 3 Optimized Discharge Electrode Pitch

Setting the discharge electrodes at a pitch that is 80 mm longer than in our previous models achieves an optimal layout that unifies ionizing performance and reduces ion recombination. This model ionizes over long distances with or without the use of an Air Purge Ionizer.

■ ZJ-BAS

A small amount of ion recombination.

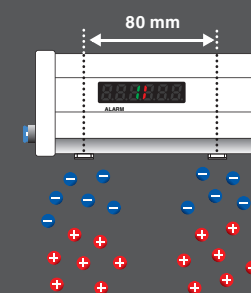

■ Previous Models

A large amount of ion recombination.

The larger pitch causes uneven ion discharge.

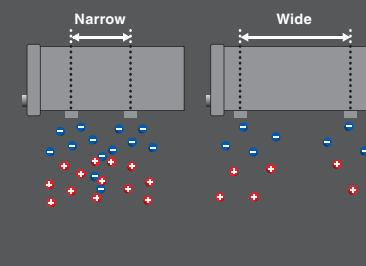

Linking
up to 7 Units*

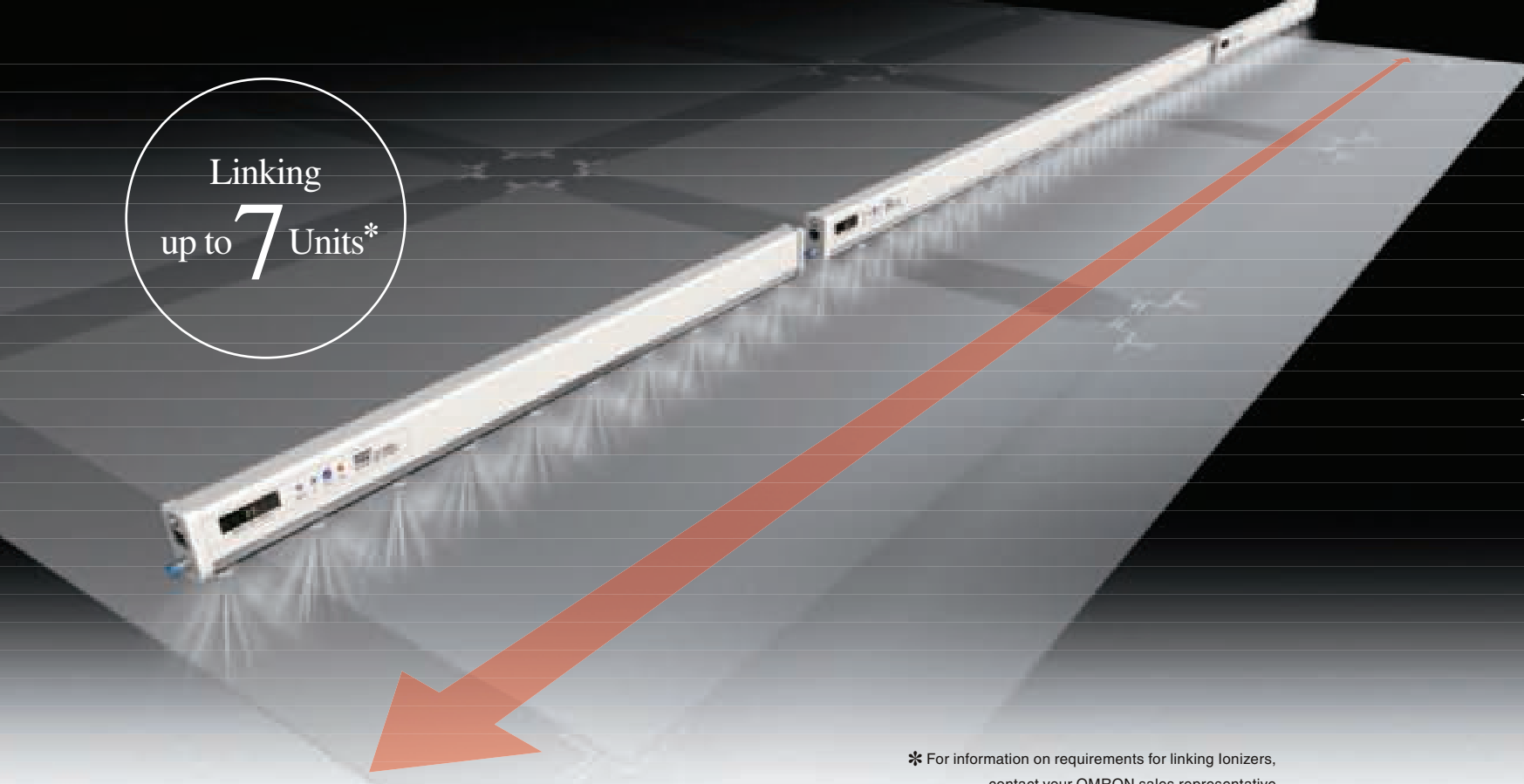

A New Proposal for Effective and Efficient Ionization

Uniform Ionization

Linked Ionizers cover a wide area without causing uneven ionization.

Long Ionizers are required to meet the needs of increasingly large liquid crystal glass panels. Ionizers as long as two meters are not only difficult to transport and install, but also pose difficulties in achieving uniform ionization. The highly thorough ZJ-BAS Ionizer solves this problem by connecting Ionizers together.

* For information on requirements for linking Ionizers, contact your OMRON sales representative.

Two Forms of Uniform Ionization Achieved by Linking Function

Uniform Airflow

The air supply ports on previous models were only on both ends, so the airflow was weak in the center of long ionizers. By connecting ZJ-BAS ionizers together, air is supplied from the center part as well, thus achieving a uniform airflow and eliminating uneven ion discharge at medium and long distances.

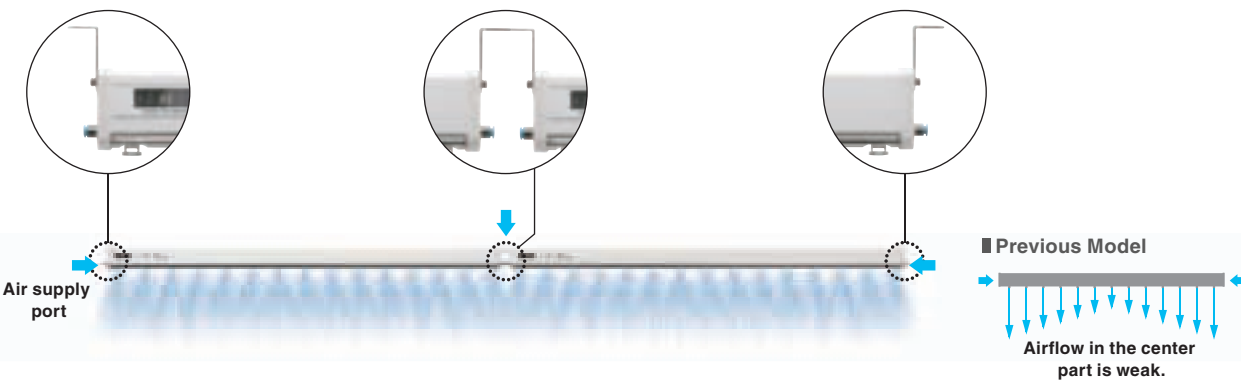

Uniform Ion Balance

For example, when both sides of a workpiece are charged, a long ionizer will adjust the amount of ions according to the entire ionizer length, so an area that is not charged may take on a reverse charge. By using linked ZJ-BAS ionizers, each ionizer senses the charge condition. Because only the ionizers on both ends then control their ion amounts in response to the charges, reverse charging does not occur.

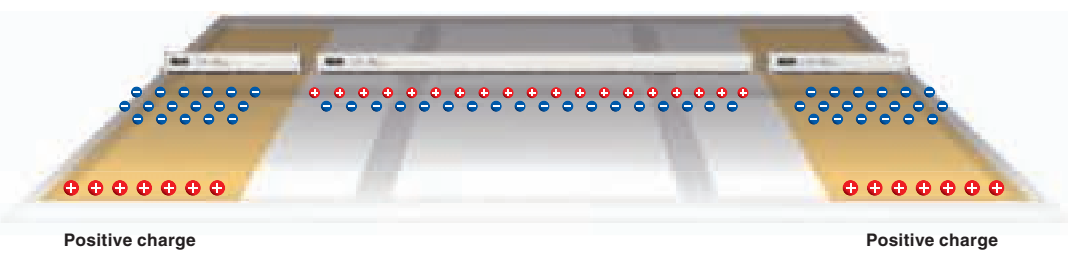

Technologies that Support Uniform Ionization

Technology 1 Supplying air with no pressure loss

By arranging discharge electrodes on both ends, the ionizer can handle an area wider than the length of the ionizer itself. This eliminates dead zones even when linking ionizers, and achieves uniform ionization.

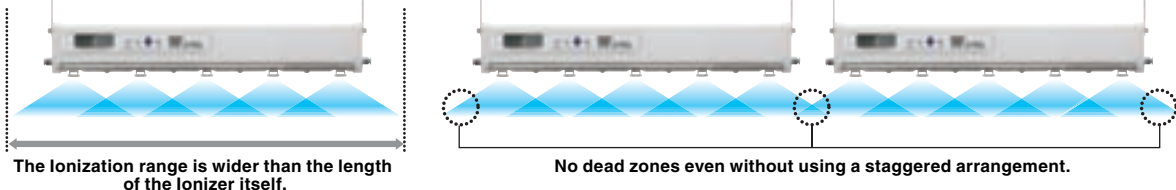

Technology 2 Ion Sensing and variable-AC system prevents ion recombination

Because the ZJ-BAS ionizer uses a method in which the linked ionizers operate using the same power supply, the positive and negative ion generation timing between the ionizers is synchronized. Also, the sensing and variable-AC system control the amount of ions while synchronizing the ionizers. This reduces ion recombination between the linked ionizers, and achieves uniform ionization.

Ion Sensing and Variable-AC System

The amount of ions is adjusted even when a charge is detected, so synchronization with matching polarity is maintained.

AC System

If the synchronization of the timing is lost, the polarity is reversed.

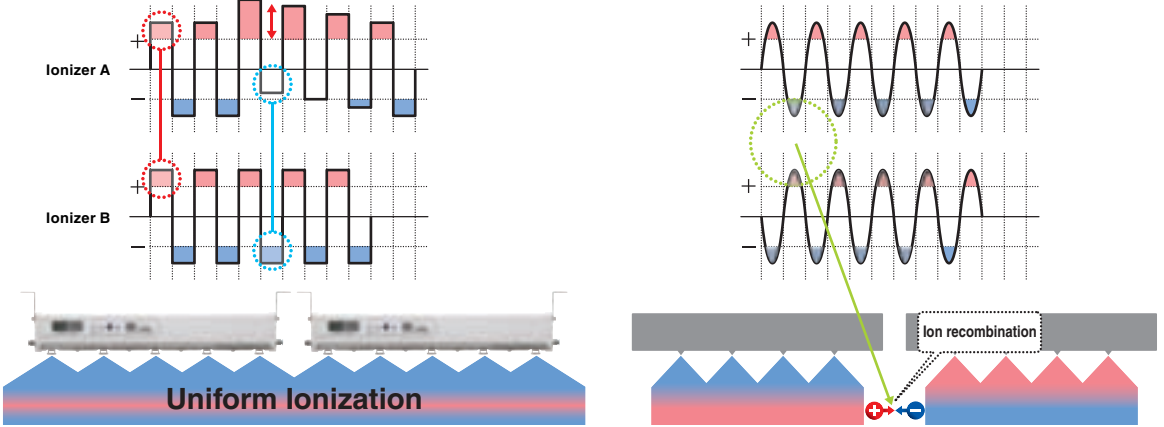

Improving Ease of Use

The Digital Ion Display Supports Safe, Reliable Settings.



From either the Remote Control or the Ionizer...

The Digital Ion Display guides you when making settings. Settings that are important for ionization performance, such as the frequency and ion balance, can be made and displayed safely and reliably from the ionizer itself, or by using the Remote Control.



Settings can be made from the Ionizer itself.



ZJ-BAS-R01/R02 (Sold separately)

A Variety of Displays

Ion Balance Display

The charged state is displayed using colors.

Negative ions Positive ions



When there are many negative ions



When there are many positive ions



Set Value Display

The current set value is shown on the right side of the display. The set value can be numerically confirmed, so the setting can be quantified. This allows identical settings to be made reliably and in a short time even across multiple ionizers.

Frequency setting



Ion balance adjustment



Cleaning sensitivity



Cleaning Display

Notifies when cleaning is required.



Setting Lock

Disables all operations.



Operation Stop Mode Makes Maintenance Easy

The Operation Stop Mode allows for safe cleaning and replacement work. The digital display and LED lamps tell you that the ionizer is in Operation Stop Mode so you won't forget to return to Operation Mode when you are finished doing maintenance. Both regular operations and maintenance can be done safely and reliably.

Operation Stop Mode



The LED lamp will flash to indicate that the ionizer is in Operation Stop Mode.

Operations from external equipment, such as stopping ionization and performing status management, can be done easily by connecting the ionizer to a PLC using an I/O cable.



PLC

M.P.S. Construction Prolongs the Required Maintenance Period by 5 Times Compared to Our Previous Model Greatly Reduces Maintenance Requirements

The M.P.S. nozzle emits clean air from around the discharge electrode, thus decreasing the amount of foreign matter adhesion, and dramatically extending the time before cleaning is required.

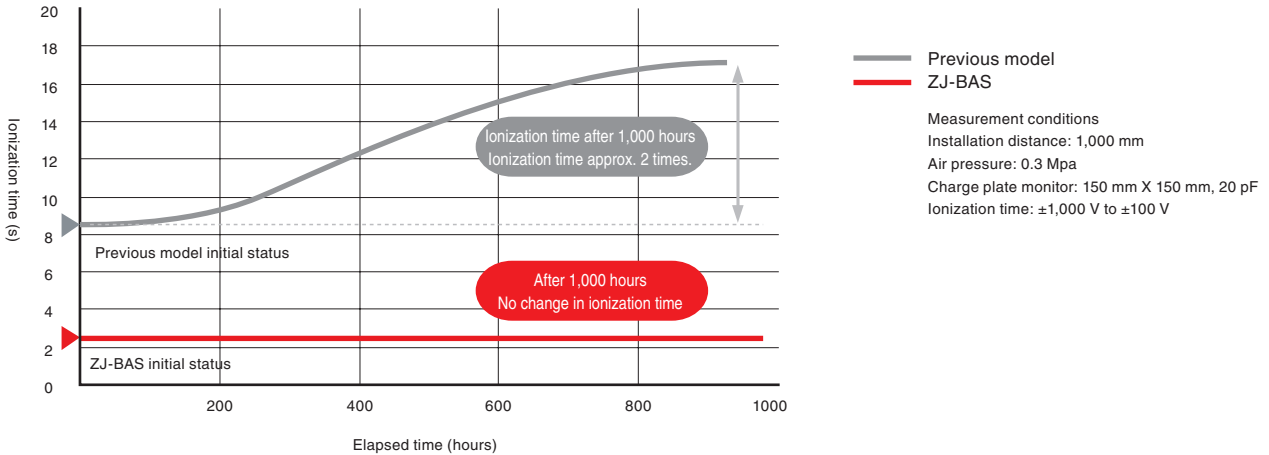

Energy-saving is a Basic Concept for OMRON Ionizers

Generally, bar-type ionizers use compressed air. Therefore, a large amount of compressed air is needed, especially for long-distance or high-speed ionization. This increases the load rate of the compressor, and consumes large amounts of electricity. The ZJ-BAS uses an optimized discharge electrode pitch and M.P.S. nozzle to improve ionization performance while using an energy-saving structure (low-current consumption) that is environmentally friendly.

The M.P.S. nozzle allows for efficient airflow while reducing current consumption.

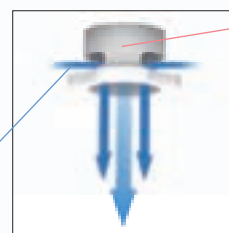

Passive air is pulled in.

80-mm Discharge Electrode Pitch Dramatically Reduces Replacement Costs

The 80 mm discharge electrode pitch and variable-AC system reduce the number of discharge electrodes required by 60%. In addition to reducing the cleaning time, the periodic replacement of the electrodes has also been reduced, thereby dramatically reducing the running cost of the ionizer.

Effective length (mm)	Number of Discharge Modules
500	5
580	6
740	8
900	10
1300	15
1540	18

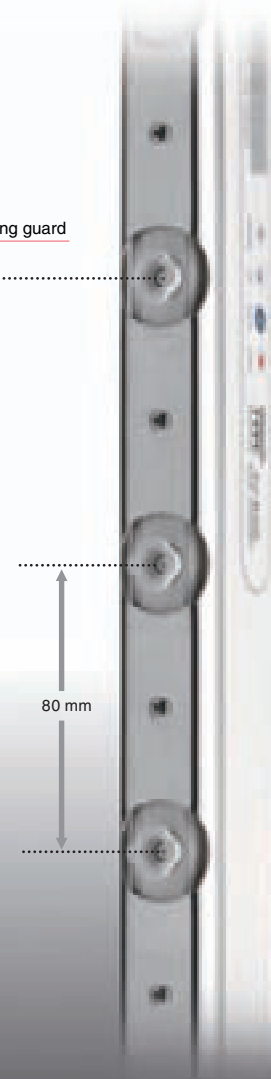

Low Running Cost.

Engineering Data

Relationship of Air Pressure and Installation Distance to Ionization Time

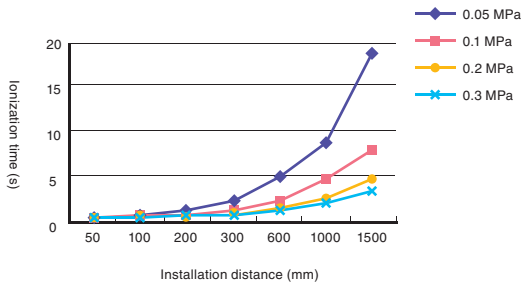

Bar Length vs. Air Pressure and Airflow

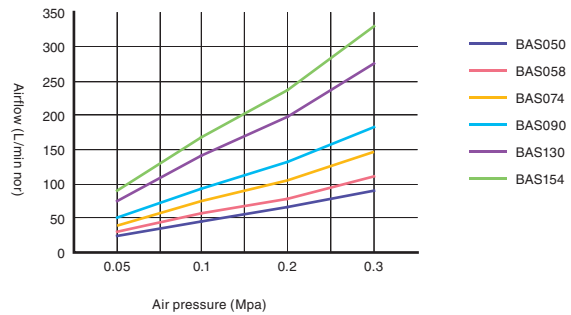

Ionization Time for Each Ionization Area

With installation distance of 50 mm (reference value)

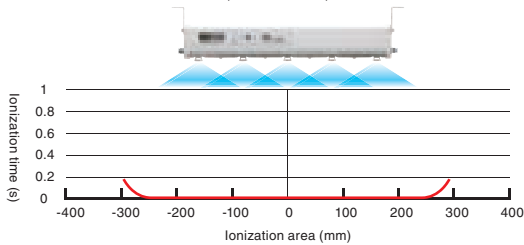

With installation distance of 1,500 mm (reference value)

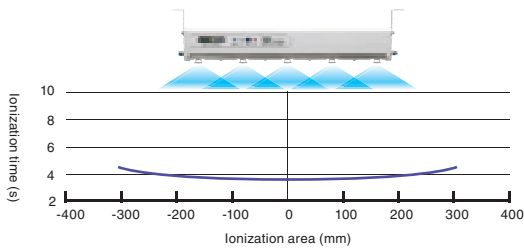

Product Configuration

Ionizer

ZJ-BAS



I/O Cable

ZJ-BAS-FC

Used for connecting external devices.



Power supply cable

Select from the two available types.

Cable with Connector on One End

ZJ-BAS-MC□□A

Used when using a DC power supply.

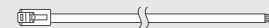

Cable with Connectors on Both Ends

ZJ-BAS-MC□□B

Used when using an AC adapter.

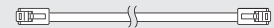

AC Adapter

ZJ-BAS-PS01



Special Remote Control

Remote Control
ZJ-BAS-R01



Remote Control Receiver
ZJ-BAS-R02



When Linking Ionizers

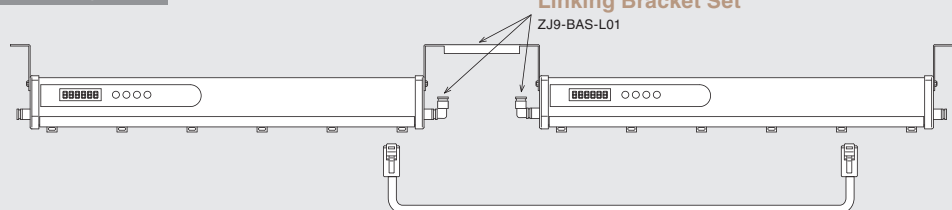

ZJ-BAS-MC□□RB Power Supply Cable (for linking ionizers)

The length of the cables that can be linked depends on the number of ionizers to be linked together. Contact your OMRON sales representative for details.



Ordering Information

Ionizer

Appearance	Total length	Effective length	Model
	370 mm	500 mm	ZJ-BAS050
	450 mm	580 mm	ZJ-BAS058
	610 mm	740 mm	ZJ-BAS074
	770 mm	900 mm	ZJ-BAS090
	1170 mm	1300 mm	ZJ-BAS130
	1410 mm	1540 mm	ZJ-BAS154

Power Supply Cable

Appearance	Type	Cable length	Model
	Cable with Connector on One End (one ferrite core provided, 30-dia X 39 mm)	2 m	ZJ-BAS-MC02A
		5 m	ZJ-BAS-MC05A
		10 m	ZJ-BAS-MC10A
		15 m	ZJ-BAS-MC15A
		20 m	ZJ-BAS-MC20A
	Cable with Connectors on Both Ends (one ferrite core provided, 30-dia X 39 mm)	2 m	ZJ-BAS-MC02B
		5 m	ZJ-BAS-MC05B
		10 m	ZJ-BAS-MC10B
		15 m	ZJ-BAS-MC15B
		20 m	ZJ-BAS-MC20B
	Used for connecting Ionizers	710 mm	ZJ-BAS-MC07RB
		790 mm	ZJ-BAS-MC08RB
		950mm	ZJ-BAS-MC09RB
		1110 mm	ZJ-BAS-MC11RB
		1510 mm	ZJ-BAS-MC15RB
		1750 mm	ZJ-BAS-MC17RB

I/O Cable

Appearance	Cable length	Model
	2 m	ZJ-BAS-FC02A
	5 m	ZJ-BAS-FC05A
	10 m	ZJ-BAS-FC10A
	15 m	ZJ-BAS-FC15A
	20 m	ZJ-BAS-FC20A

AC Adapter

Appearance	Specifications	Model
	Input: 100 to 240 VAC Output: 24 VDCx2	ZJ-BAS-PS01

Special Remote Control

Appearance	Type	Model
	Remote Control	ZJ-BAS-R01
	Remote Control Receiver (Receiver, USB cable, bracket)	ZJ-BAS-R02

Linking Bracket Set

Appearance	Contents	Model
	Linking Bracket (1) 6-dia. Elbow Air Joint (x2)	ZJ9-BAS-L01

Discharge Electrode Module

Appearance	Quantity	Model
	Set of 5	ZJ9-BAS-NT105
	Set of 10	ZJ9-BAS-NT110

Cleaning Tool

Appearance	Quantity	Model
	Set of 20 jig	ZJ9-BA-CT01

Ratings and Characteristics

Ionizer

Item	Model	ZJ-BAS050	ZJ-BAS058	ZJ-BAS074	ZJ-BAS090	ZJ-BAS130	ZJ-BAS154
Ionizer length (mm)		370	450	610	770	1170	1410
Effective ionization length (mm) (*1.)		500	580	740	900	1300	1540
Power supply voltage		24 VDC ±10%, ripple (p-p) 10% max.					
Current consumption		520 Ma max. (discharge frequency 0.08 to 0.5 Hz: 400 mA (typical), 1 to 10 Hz: 350 mA (typical), 20 to 40 Hz: 300 mA (typical))					
Discharge method		Sensing and a Variable-AC System					
Discharge voltage		6.5 k VP-P					
Discharge electrode		Tungsten electrode					
Recommended installation distance		50 to 2,000 mm					
Ion balance (*2)		±30 V max.					
Power supply connector		Modular type, 8-pin connector (at both ends of Unit)					
Air inlet		6-dia one-touch coupling (at both ends of Unit)					
Maximum air pressure		0.3 MPa max.					
External I/O	Input	Discharge stop input (Turns ON at 12 to 24 VDC), input impedance: 8.2 kΩ					
	Output	Discharge stop output, cleaning output, alarm output, high-pressure error output: Signal output from photo MOS relay (100 mA max at 24 VDC)					
Display		Seven-segment LED display					
ID number		001 to 050					
Ion balance adjustment function		Yes					
Maximum number of linkable units		7 Units					
Material		Ionizer: ABS-resin, facing electrodes: Stainless steel					
Ambient temperature range		Operating: 10 to 40°C, Storage: 0 to 40°C (with no icing or condensation)					
Ambient humidity range		Operating: 35% to 65%, Storage: 35% to 85% (with no condensation)					
Weight (Ionizer only)		Approx. 0.58 kg	Approx. 0.64 kg	Approx. 0.8 kg	Approx. 0.94 kg	Approx. 1.28 kg	Approx. 1.5 kg
Accessories		Two mounting brackets, two M4 screws, instruction manual				Two mounting brackets, two M4 screws, 1 medium bracket, instruction manual	

*1 Measurement conditions Installation distance: 50 mm

Airflow: 1 L /min per hole

Frequency: 10 Hz

Charge plate monitor: 150 × 150 mm, 20 pF

Ionization time: (1,000 V→100V/–1,000V→–100V): 1 s max.)

*2 Measurement conditions Installation distance: 300 mm

Airflow: 1 L /min per hole

Frequency: 10 Hz

Charge plate monitor: 150 × 150 mm, 20 pF

AC Adaptor

Item	Model	ZJ-BAS-PS01
Input voltage		100 to 240 VAC
Input current		1.2A max.
Output voltage		24 VDC
Output current		3.75A max.
Number of output ports		2 ports
Product configuration		Adaptor box, AC adaptor AC power cable
Weight (without package)		Adapter box: Approx. 30 g AC Adaptor: Approx. 430 g AC power supply cable: Approx. 260 g

Special Remote Control

Item	Model	ZJ-BAS-R01	ZJ-BAS-R02
Product configuration		Remote Control only	Receiver Cable (150 mm) Brackets (not including Remote Control)
	Communications method	Infrared communications	
Number of detectable Units		50 Units	–
Power supply		Three AAA batteries	Supplied from the ZJ-BAS Ionizer
Weight (not including packaging)		Approx. 115 g	Receiver: Approx. 5 g Cable: Approx. 6 g Bracket: Approx. 5 g
Accessories		Instruction manual	

Dimensions

(Units: mm)

Ionizer

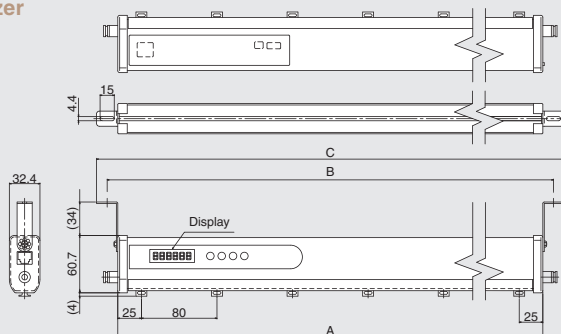

Mounting bracket

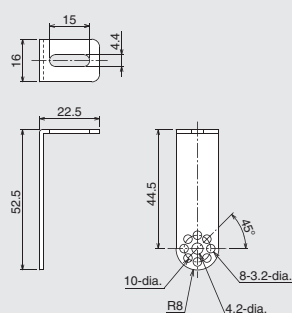

The dimensions and number of Discharge Electrode Modules for each model are shown in the following table.

Model	A (mm)	B (mm)	C (mm)	Discharge Electrode Module
ZJ-BAS050	370	394	416	5
ZJ-BAS058	450	474	496	6
ZJ-BAS074	610	634	656	8
ZJ-BAS090	770	794	816	10
ZJ-BAS130	1170	1194	1216	15
ZJ-BAS154	1410	1434	1456	18

Auxiliary mounting bracket

Provided with the ZJ-BAS130/BAS154

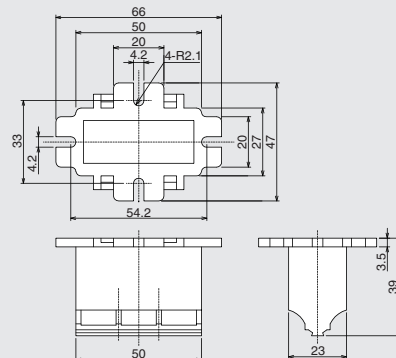

Dimensions

(Units: mm)

Power Supply Cable

ZJ-BAS-MC□□A

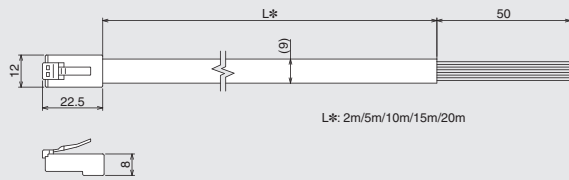

ZJ-BAS-MC□□B/MC□□RB

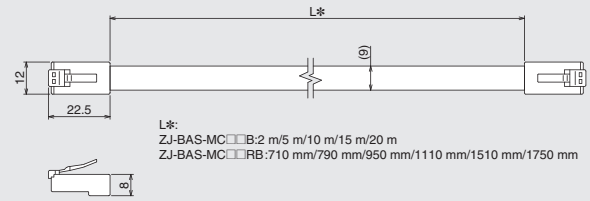

I/O Cable

ZJ-BAS-FC□□A

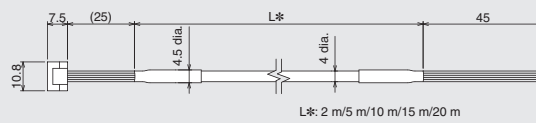

AC Adapter

(Adapter box)

ZJ-BAS-PS01

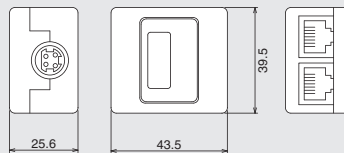

Remote Control

ZJ-BAS-R01

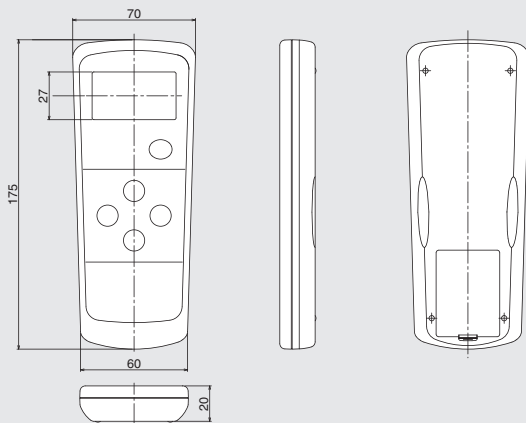

Receiver for the Remote Control

(Bracket)

ZJ-BAS-R02

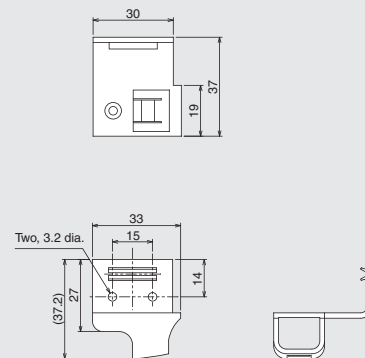

Linking Bracket

ZJ9-BAS-L01

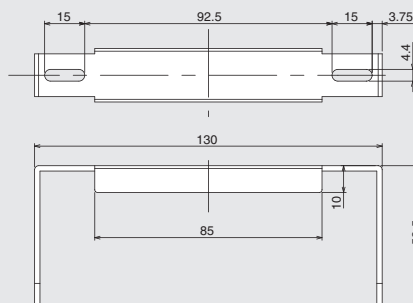

Material: Stainless steel (SUS304)

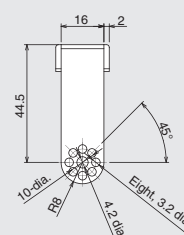

This document provides information mainly for selecting suitable models. Please read the Instruction Sheet carefully for information that the user must understand and accept before purchase, including information on warranty, limitations of liability, and precautions.

OMRON Corporation
Industrial Automation Company
Sensing Devices Division H.Q.
Application Sensors Division

Shiokoji Horikawa, Shimogyo-ku,
Kyoto, 600-8530 Japan
Tel: (81) 75-344-7068/Fax: (81) 75-344-7107

Regional Headquarters

OMRON EUROPE B.V.

Sensor Business Unit
Carl-Benz-Str. 4, D-71154 Nufringen,
Germany
Tel: (49) 7032-811-0/Fax: (49) 7032-811-199

OMRON ELECTRONICS LLC

One Commerce Drive Schaumburg,
IL 60173-5302 U.S.A.
Tel: (1) 847-843-7900/Fax: (1) 847-843-7787

OMRON ASIA PACIFIC PTE. LTD.

No. 438A Alexandra Road # 05-05/08 (Lobby 2),
Alexandra Technopark, Singapore 119967
Tel: (65) 6835-3011/Fax: (65) 6835-2711

OMRON (CHINA) CO., LTD.

Room 2211, Bank of China Tower,
200 Yin Cheng Zhong Road,
PuDong New Area, Shanghai, 200120, China
Tel: (86) 21-5037-2222/Fax: (86) 21-5037-2200

Authorized Distributor:

© OMRON Corporation 2008 All Rights Reserved.
In the interest of product improvement,
specifications are subject to change without notice.